

И. И. 吉米多维奇

数学分析习题集题解

费定晖 周学圣 编演
谷大珩 邵品琮 主审

山东科学技术出版社

В.П.吉米多维奇

数学分析习题集题解

(五)

费定晖 周学圣 编演

郭大钧 邵品琮 主审

山东科学技术出版社

一九八一年·济南

Б.П.吉米多维奇
数学分析习题集题解
(五)

费定晖 周学孟 编演
郭大钧 邵品琮 主审

*

山东科学技术出版社出版
山东省新华书店发行
山东人民印刷厂印刷

*

787×1092毫米32开本 24.375印张 620千字
1980年7月第1版 1981年11月第2次印刷
印数: 82,001—110,000

书号 13195·21 定价 2.60元

出版说明

吉米多维奇(Б.П.ДЕМИДОВИЧ)著《数学分析习题集》一书的中译本,自五十年代初在我国翻译出版以来,引起了全国各大专院校广大师生的巨大反响。凡从事数学分析教学的师生,常以试解该习题集中的习题,作为检验掌握数学分析基本知识和基本技能的一项重要手段。二十多年来,对我国数学分析的教学工作是甚为有益的。

该书四千多道习题,数量多,内容丰富,由浅入深,部分题目难度大。涉及的内容有函数与极限,单变量函数的微分学,不定积分,定积分,级数,多变量函数的微分学,带参变量积分以及重积分与曲线积分、曲面积分等等,概括了数学分析的全部主题。当前,我国广大读者,特别是肯于刻苦自学的广大数学爱好者,在为四个现代化而勤奋学习的热潮中,迫切需要对一些疑难习题有一个较明确的回答。有鉴于此,我们特约作者,将全书4462题的所有解答汇辑成书,共分六册出版。本书可以作为高等院校的教学参考用书,同时也可作为广大读者在自学微积分过程中的参考用书。

众所周知,原习题集,题多难度大,其中不少习题如果认真习作的话,既可以深刻地巩固我们所学到的基本概念,又可以有效地提高我们的运算能力,特别是有些难题还可以逼使我们学会综合分析的思维方法。正由于这样,我们殷切期望初学数学分析的青年读者,一定要刻苦钻研,千万不要轻易

查抄本书的解答，因为任何削弱独立思索的作法，都是违背我们出版此书的本意。何况所作解答并非一定标准，仅作参考而已。如有某些误解、差错也在所难免，一经发觉，恳请指正，不胜感谢。

本书蒙潘承洞教授对部分难题进行了审校。特请郭大钧教授、邵品琮副教授对全书作了重要仔细的审校。其中相当数量的难度大的题，都是郭大钧、邵品琮亲自作的解答。

参加本册审校工作的还有张致先、徐沅同志。

参加编演工作的还有黄春朝同志。

本书在编审过程中，还得到山东大学、山东工学院、山东师范学院和曲阜师范学院的领导和同志们的大力支持，特在此一并致谢。

1979年4月

目 录

第六章 多变量函数的微分法	1
§1. 多变量函数的极限. 连续性	1
§2. 偏导函数. 多变量函数的微分	39
§3. 隐函数的微分法	152
§4. 变量代换	230
§5. 几何上的应用	337
§6. 台劳公式	387
§7. 多变量函数的极值	415
第七章 带参数的积分	525
§1. 带参数的常义积分	525
§2. 带参数的广义积分. 积分的一致收敛性	567
§3. 广义积分中的变量代换. 广义积分号下 微分法及积分法	618
§4. 尤拉积分	709
§5. 福里叶积分公式	752

第六章 多变量函数的微分法

§1. 多变量函数的极限. 连续性

1° 多变量函数的极限 设函数 $f(P) = f(x_1, x_2, \dots, x_n)$ 在以 P_0 为聚点的集合 E 上有定义. 若对于任何的 $\varepsilon > 0$ 存在有 $\delta = \delta(\varepsilon, P_0) > 0$, 使得只要 $P \in E$ 及 $0 < \rho(P, P_0) < \delta$ (其中 $\rho(P, P_0)$ 为 P 和 P_0 二点间的距离), 则

$$|f(P) - A| < \varepsilon,$$

我们就说

$$\lim_{P \rightarrow P_0} f(P) = A.$$

2° 连续性 若

$$\lim_{P \rightarrow P_0} f(P) = f(P_0),$$

则称函数 $f(P)$ 于 P_0 点是连续的.

若函数 $f(P)$ 于已知域内的每一点连续, 则称函数 $f(P)$ 于此域内是连续的.

3° 一致连续性 若对于每一个 $\varepsilon > 0$ 都存在有仅与 ε 有关的 $\delta > 0$, 使得对于域 G 中的任何点 P', P'' , 只要是

$$\rho(P', P'') < \delta,$$

便有不等式

$$|f(P') - f(P'')| < \varepsilon$$

成立, 则称函数 $f(P)$ 于域 G 内是一致连续的.

于有界闭域内的连续函数于此域内是一致连续的。

确定并绘出下列函数存在的域：

3136. $u = x + \sqrt{y}$.

解 存在域为半平面，

$$y \geq 0,$$

如图 6.1 阴影部分所示，包括整个 Ox 轴在内。



图 6.1

3137. $u = \sqrt{1-x^2}$

$$+ \sqrt{y^2-1}.$$

解 存在域为满足不等式

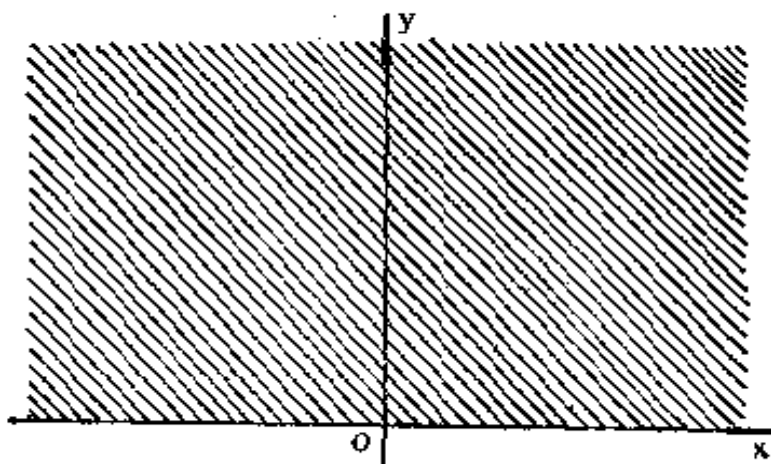
$$|x| \leq 1, |y| \geq 1$$

的点集，如图 6.2 阴影部分所示，包括边界（粗实线）在内。



图 6.2

3138. $u = \sqrt{1-x^2-y^2}$.

解 存在域为圆

$$x^2 + y^2 \leq 1,$$

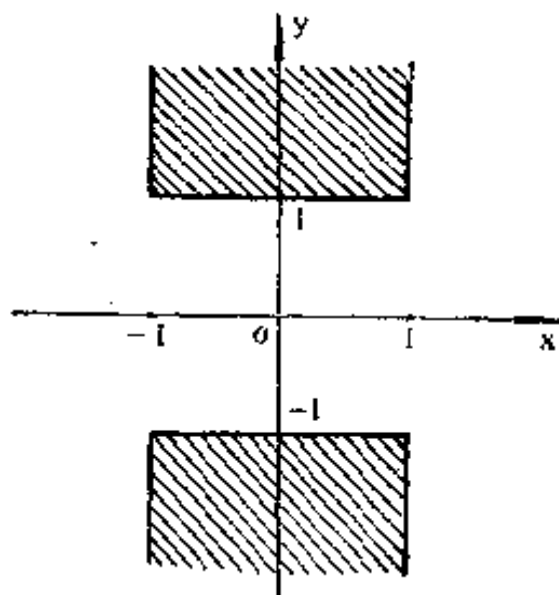
如图 6.3 阴影部分所示, 包括圆周在内.

3139. $u = \frac{1}{\sqrt{x^2 + y^2 - 1}}$.

解 存在域为满足不等式

$$x^2 + y^2 > 1$$

的点集, 即圆 $x^2 + y^2 = 1$ 的外面, 如图 6.4 所示, 不包括圆周 (虚线) 在内.

3140. $u = \frac{1}{\sqrt{(x^2 + y^2 - 1)(4 - x^2 - y^2)}}$.

解 存在域为满足不等式

$$1 \leq x^2 + y^2 \leq 4$$

的点集, 如图 6.5 所示的环, 包括边界在内.

3141. $u = \sqrt{\frac{x^2 + y^2 - x}{2x - x^2 - y^2}}$.

解 存在域为满足不等式

$$x \leq x^2 + y^2 < 2x$$

的点集. 由 $x^2 + y^2$



图 6.3



图 6.4

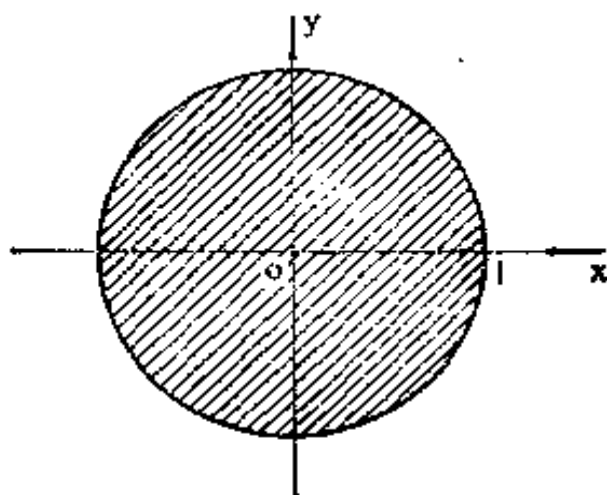

图 6.5

$\geq x$ 得出

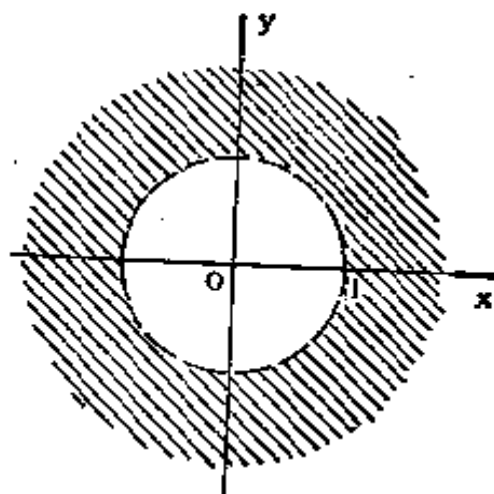
$$\left(x - \frac{1}{2}\right)^2 + y^2 \geq \left(\frac{1}{2}\right)^2,$$

由 $x^2 + y^2 < 2x$ 得出

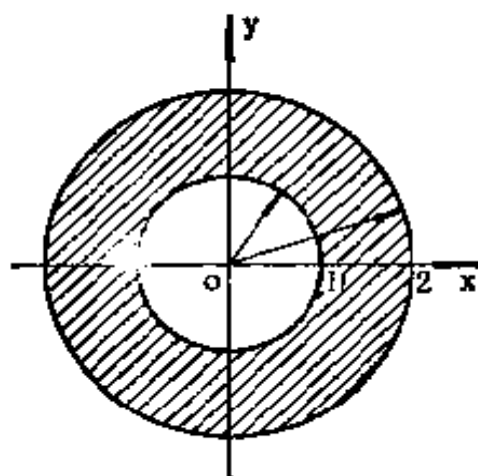
$$(x-1)^2 + y^2 < 1,$$

两者组成一月形, 如图 6.6 阴影部分所示.



图 6.6

3142. $u = \sqrt{1 - (x^2 + y)^2}$.

解 存在域为满足不等式

$$-1 \leq x^2 + y \leq 1$$

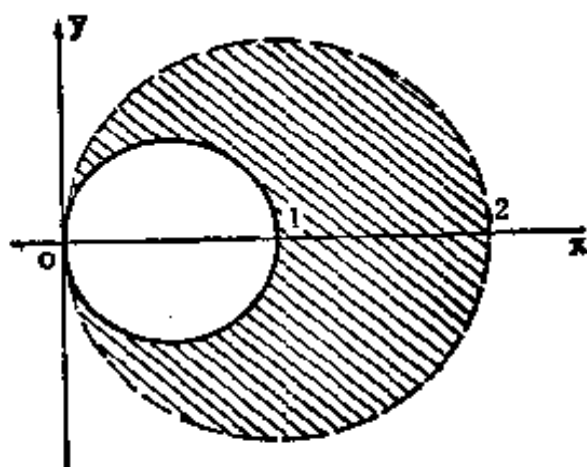
的点集, 如图 6.7 阴影部分所示, 包括边界在内.



图 6.7

3143. $u = \ln(-x - y)$.

解 存在域为半平面

$$x + y < 0,$$

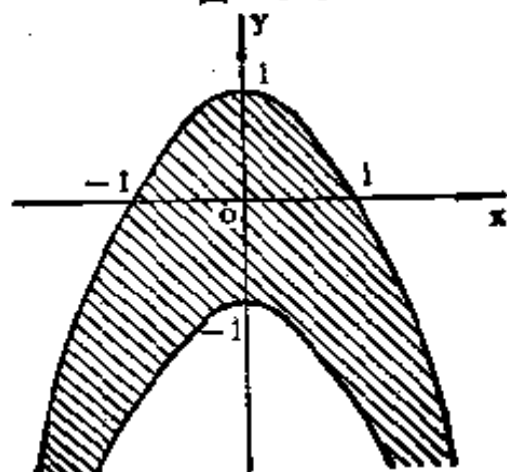
如图 6.8 阴影部分所示, 不包括直线 $x + y = 0$ 在内.



图 6.8

3144. $u = \arcsin \frac{y}{x}$.

解 存在域为满足

不等式

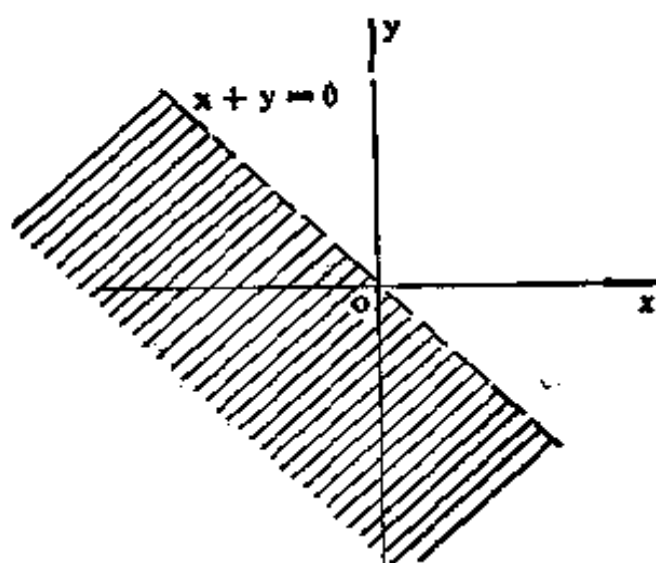
$$\left| \frac{y}{x} \right| \leq 1$$

或 $|y| \leq |x|$ ($x \neq 0$)
 的点集，这是一对对顶的直角，如图 6·9 阴影部分所示，不包括原点在内。



图 6·9

3145. $u = \arccos \frac{x}{x+y}$

解 存在域为满足不等式

$$\left| \frac{x}{x+y} \right| \leq 1$$

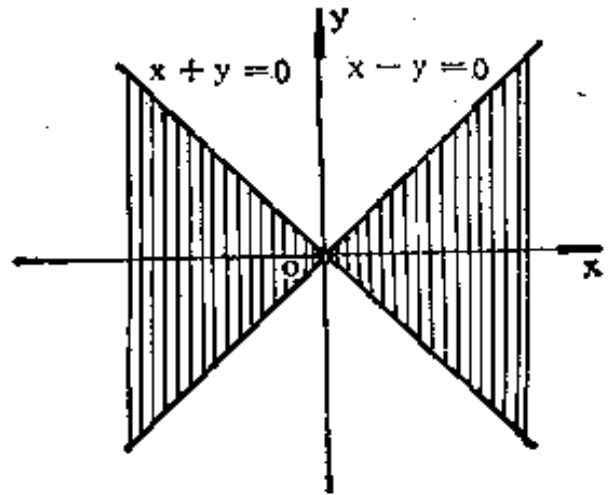
的点集。由 $\left| \frac{x}{x+y} \right| \leq 1$ 得 $|x| \leq |x+y|$ ($x \neq -y$),

即 $x^2 \leq x^2 + 2xy + y^2$ 或 $y(y+2x) \geq 0$, 也即

$$\begin{cases} y \geq 0, \\ y \geq -2x, \end{cases} \quad \text{或} \quad \begin{cases} y \leq 0, \\ y \leq -2x. \end{cases}$$

但 x, y 不能同时为零。这是由直线: $y = 0$ 和 $y = -2x$ 所围成的一对对顶的角，如图 6·10 阴影部分所示，包括边界在内，但不包括公共顶点 $O(0,0)$ 在内。



图 6·10

3146. $u = \arcsin \frac{x}{y^2} + \arcsin(1 - y)$.

解 存在域为满足不等式

$$\left| \frac{x}{y^2} \right| \leq 1 \text{ 及 } |1 - y| \leq 1 \text{ (} y \neq 0 \text{)}$$

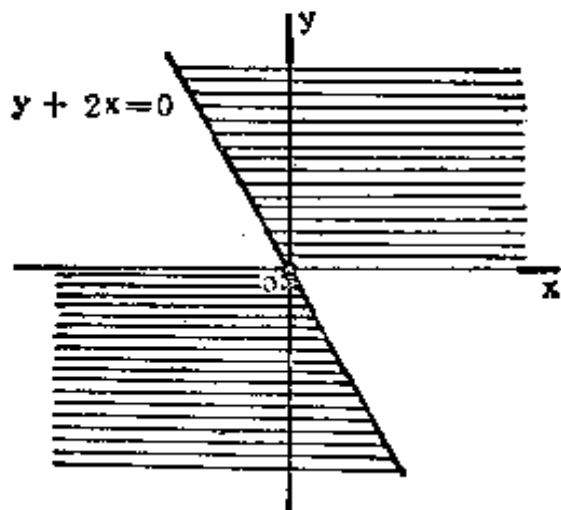
的点集, 即

$$\begin{cases} y^2 \geq x, \\ 0 < y \leq 2 \end{cases} \text{ 和}$$

$$\begin{cases} y^2 \geq -x, \\ 0 < y \leq 2. \end{cases}$$

这是由抛物线:

$$y^2 = x, \quad y^2 = -x$$

和直线 $y = 2$ 所围成的曲边三角形, 如图6·11阴影部分所示, 不包括原点在内.



图 6·11

3147. $u = \sqrt{\sin(x^2 + y^2)}$.

解 存在域为满足不等式

$$\sin(x^2 + y^2) \geq 0$$

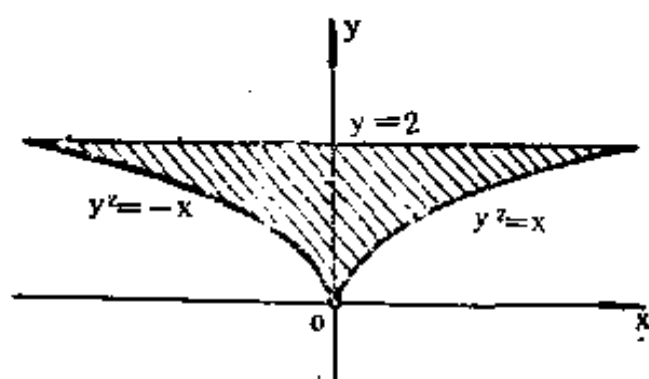
$$\text{或 } 2k\pi \leq x^2 + y^2$$

$$\leq (2k+1)\pi \text{ (} k$$

$= 0, 1, 2, \dots$) 的点集, 如图6·12所示的同心环族.



图 6·12

$$3148. u = \arccos \frac{z}{\sqrt{x^2 + y^2}}$$

解 存在域为满足不等式

$$\left| \frac{z}{\sqrt{x^2 + y^2}} \right| \leq 1$$

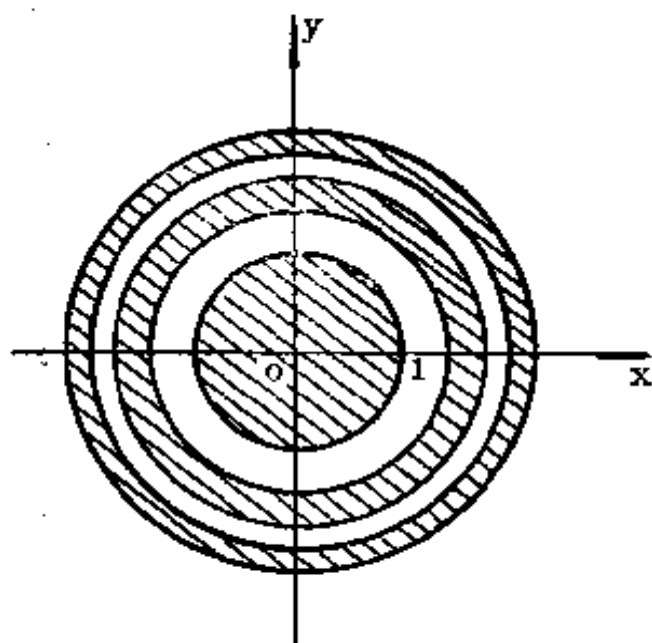
(x, y 不同时为零)

或

$$x^2 + y^2 - z^2 \geq 0$$

(x, y 不同时为零)



图 6·13

的点集，这是圆锥 $x^2 + y^2 - z^2 = 0$ 的外面，如图 6·13 阴影部分所示，包括边界在内，但要除去圆锥的顶点。

$$3149. u = \ln(xyz).$$

解 存在域为满足不等式

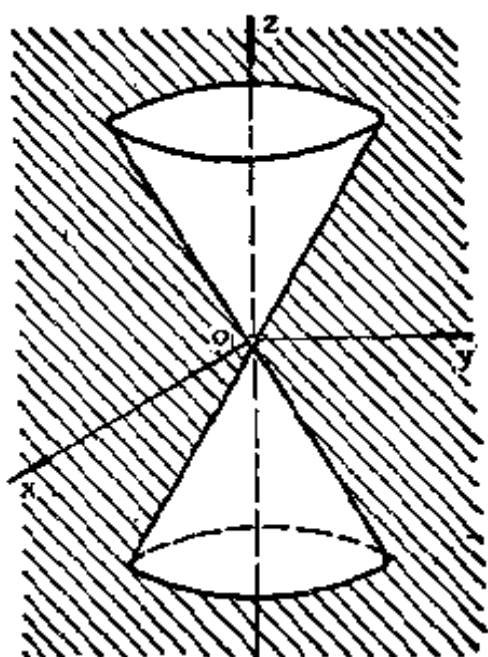
$$xyz > 0$$

的点集，即

$$x > 0, y > 0, z > 0; \text{ 或 } x > 0, y < 0, z < 0;$$

$$x < 0, y < 0, z > 0; \text{ 或 } x < 0, y > 0, z < 0.$$

其图形为空间第一、第三、第六及第八卦限的总体，但不包括坐标面。由于图形为读者所熟知，故省略。以下有类似情况，不再说明。

$$3150. u = \ln(-1 - x^2 - y^2 + z^2).$$

解 存在域为满足不等式

$$-x^2 - y^2 + z^2 > 1$$

的点集。这是双叶双曲面 $x^2 + y^2 - z^2 = -1$ 的内部，如图6·14阴影部分所示，不包括界面在内。

作出下列函数的等位线：



图 6·14

3151. $z = x + y$.

解 等位线为平行直线族

$$x + y = k,$$

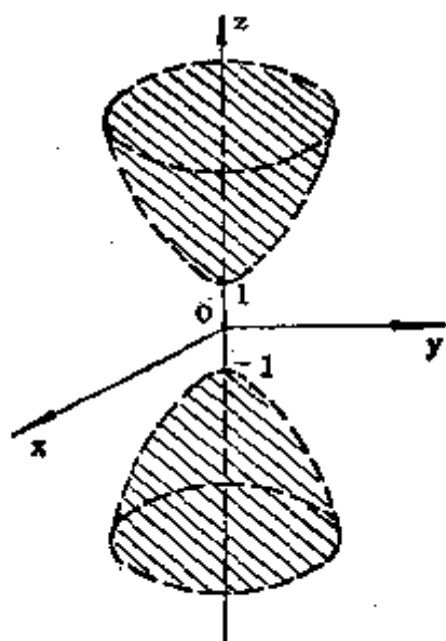
其中 k 为一切实数，如图6·15所示。

3152. $z = x^2 + y^2$.

解 等位线为曲线族

$$x^2 + y^2 = a^2$$

$$(a \geq 0).$$

当 $a = 0$ 时为原点；当 $a > 0$ 时，等位线为以原点为圆心的同心圆族。



图 6·15

3153. $z = x^2 - y^2$.

解 等位线为曲线族

$$x^2 - y^2 = k.$$

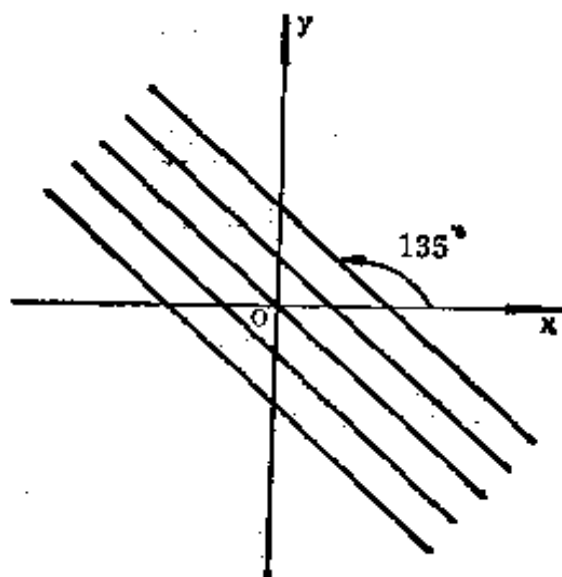
当 $k = 0$ 时为两条互相垂直的直线： $y = x, y = -x$ 。

当 $k \neq 0$ 时为以 $y = \pm x$ 为公共渐近线的等边双曲线族，其中当 $k > 0$ 时顶点为 $(-\sqrt{k}, 0), (\sqrt{k}, 0)$ ，当 $k < 0$ 时顶点为 $(0, -\sqrt{-k}), (0, \sqrt{-k})$ 。

3154. $z = (x + y)^2$.

解 等位线为曲线族

$$(x + y)^2 = a^2 \quad (a \geq 0).$$

当 $a = 0$ 为直线 $x + y = 0$ 。当 $a \neq 0$ 时为与直线 $x + y = 0$ 平行的且等距的直线 $x + y = \pm a$ 。

3155. $z = \frac{y}{x}$.

解 等位线为以坐标原点为束心的直线束

$$y = kx \quad (x \neq 0),$$

不包括 Oy 轴在内。

3156. $z = \frac{1}{x^2 + 2y^2}$.

解 等位线为椭圆族

$$x^2 + 2y^2 = a^2 \quad (a > 0).$$

长半轴为 a ，短半轴为 $\frac{a}{\sqrt{2}}$ ，焦点为 $(-a\sqrt{\frac{3}{2}}, 0)$

及 $(a\sqrt{\frac{3}{2}}, 0)$ 。

3157. $z = \sqrt{xy}$.

解 等位线为曲线族

$$xy = a^2 \quad (a \geq 0).$$

当 $a = 0$ 时为坐标轴 $x = 0$ 及 $y = 0$ 。当 $a > 0$ 时为以两坐标轴为公共渐近线且位于第一、第三象限内的等

边双曲线族，顶点为
 $(-a, -a)$ 及 (a, a) 。

3158. $z = |x| + y$.

解 等位线为曲线族

$$|x| + y = k,$$

其中 k 为一切实数. 当
 $x \geq 0$ 时为 $x + y = k$;

当 $x < 0$ 时为 $-x + y = k$. 这是顶点在 Oy
 轴上两支互相垂直的
 射线所构成的折线
 族, 如图6.16所示.



图 6.16

3159. $z = |x| + |y| - |x + y|$.

解 等位线为曲线族

$$|x| + |y| - |x + y| = a.$$

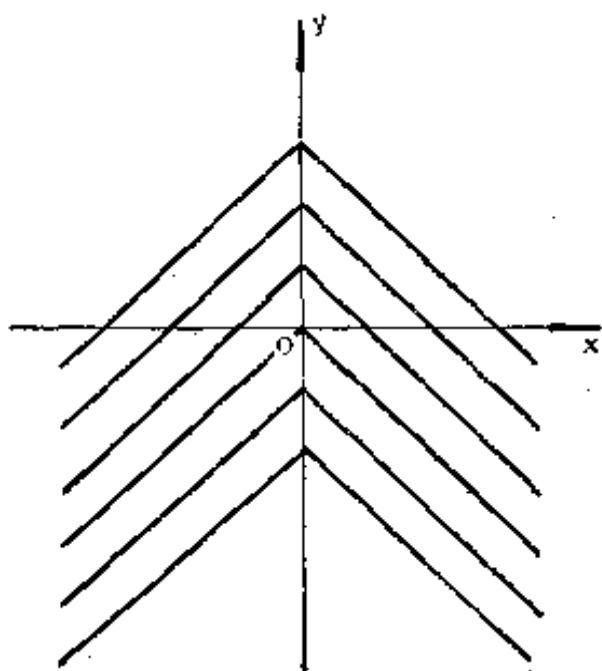
因为恒有 $|x| + |y| \geq |x + y|$, 所以 $a \geq 0$.

当 $a = 0$ 时, 由 $|x| + |y| = |x + y|$ 两边平方即得

$$xy \geq 0,$$

即为整个第一、第三象限, 包括两坐标轴在内.

当 $a > 0$ 时, $xy < 0$, 分下面四组求解:

(1) $x > 0, y < 0, x + y \geq 0, |x| + |y| - |x + y|$

$$= a, \text{ 解之得 } y = -\frac{a}{2};$$

(2) $x > 0, y < 0, x + y \leq 0, |x| + |y| - |x + y|$

$$= a, \text{ 解之得 } x = \frac{a}{2};$$

$$(3) \quad x < 0, y > 0, x + y \geq 0, |x| + |y| - |x + y| = a, \text{解之得 } x = -\frac{a}{2};$$

$$(4) \quad x < 0, y > 0, x + y \leq 0, |x| + |y| - |x + y| = a, \text{解之得 } y = \frac{a}{2}.$$

这是顶点位于直线 $x + y = 0$ 上的两支互相垂直的折线族，它的各射线平行于坐标轴，如图 6.17 所示。



图 6.17

3160. $z = e^{\frac{2x}{x^2 + y^2}}$

解 等位线为曲线族

$$\frac{2x}{x^2 + y^2} = k \quad (x, y \text{ 不同时为零}),$$

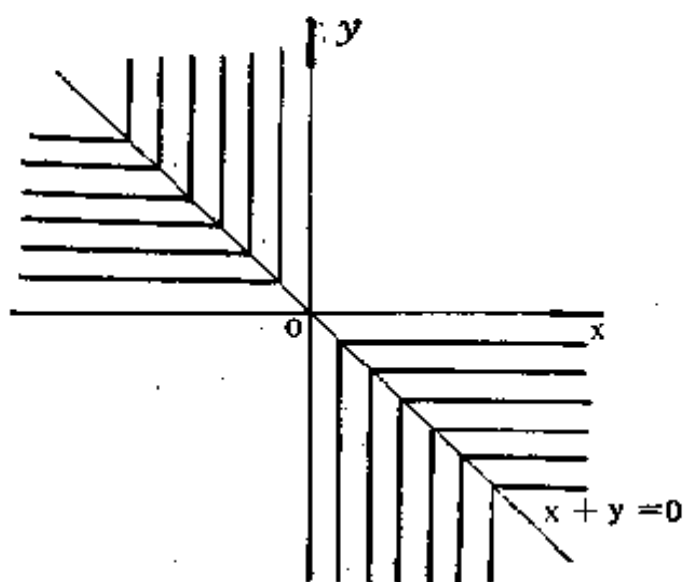
其中 k 为异于零的一切实数。上式可变形为

$$\left(x - \frac{1}{k}\right)^2 + y^2 = \left(\frac{1}{k}\right)^2 \quad (k \neq 0).$$

当 $k = 0$ 时，即得 $e^{\frac{2x}{x^2 + y^2}} = 1$ ，从而等位线为 $x = 0$ 即 Oy 轴，但不包括原点。

当 $k \neq 0$ 时为 中心在 Ox 轴上且 经过坐标原点 (但不包括原点在 内) 的圆束, 圆心在 $(\frac{1}{k}, 0)$, 半径为 $|\frac{1}{k}|$,

如图 6.18 所示.



图 6.18

3161. $z = x^a (x > 0)$.

解 等位线为曲线族

$$x^a = a \quad (a > 0).$$

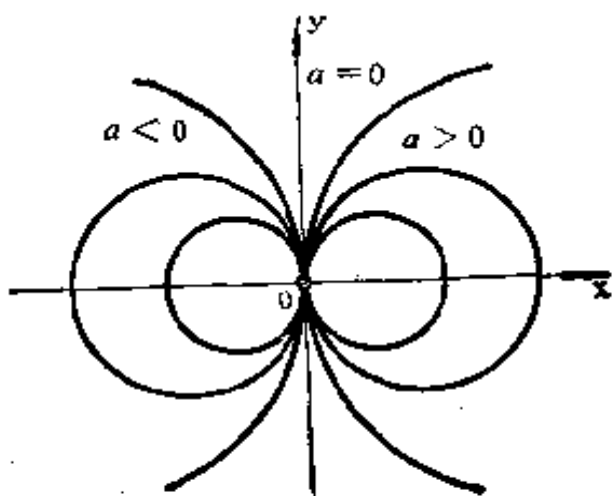
当 $a = 1$ 时为直线 $x = 1$ 及 Ox 轴的正向半射线, 但不包括原点在 内.

当 $0 < a < 1$ 与 $a > 1$ 时的图象如图 6.19 所示.



图 6.19

3162. $z = x^a e^{-x} (x > 0)$.

解 等位线为曲线族

$$x^y e^{-x} = a \quad (a > 0),$$

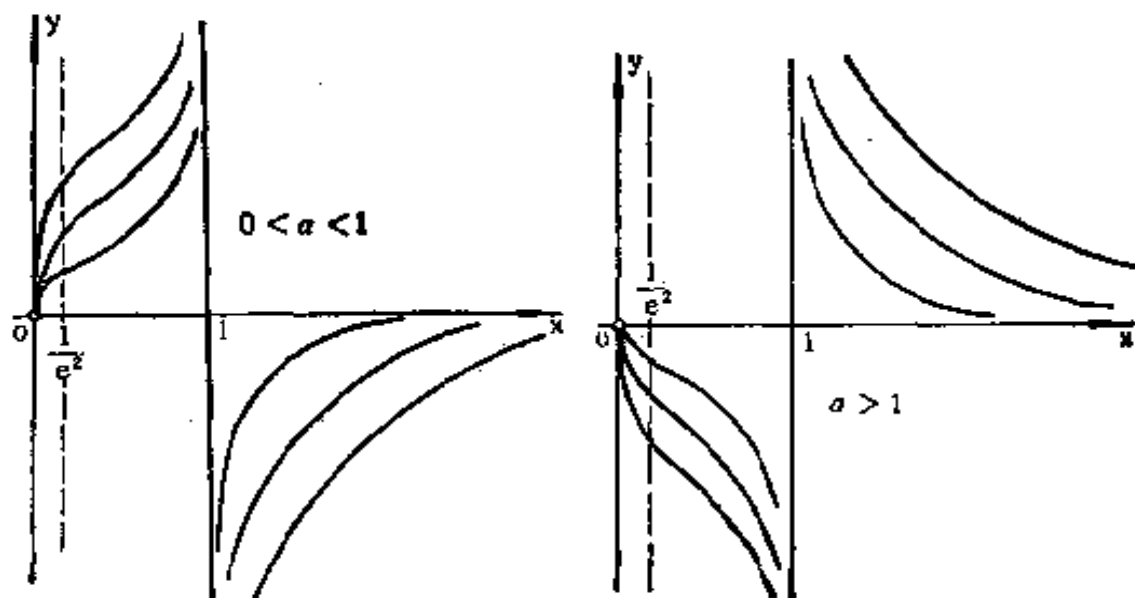
即

$$y \ln x - x = \ln a.$$

当 $a = e^{-1}$ 时为直线 $x = 1$

和曲线 $y = \frac{x-1}{\ln x}$; 当 $0 < a$

$< \frac{1}{e}$, $\frac{1}{e} < a < 1$ 或 $a \geq 1$ 时

图象布满整个右半平面, 如图 6.20 所示, 不包括 Oy 轴.



图 6.20

3163.
$$z = \ln \sqrt{\frac{(x-a)^2 + y^2}{(x+a)^2 + y^2}} \quad (a > 0).$$

解 等位线为曲线族

$$\frac{(x-a)^2 + y^2}{(x+a)^2 + y^2} = k^2 \quad (k > 0).$$

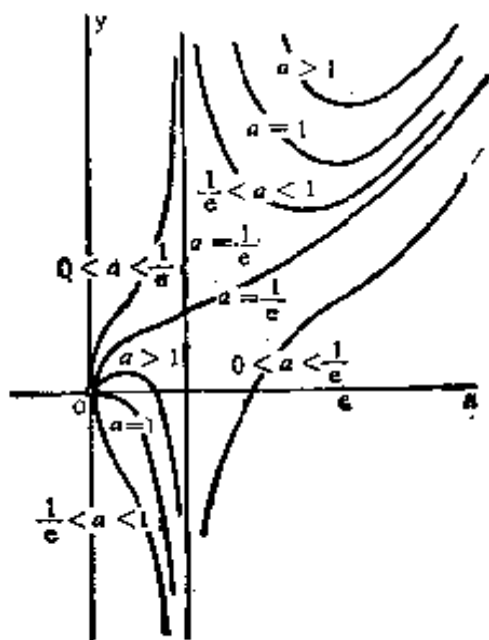
整理得

$$(1-k^2)x^2 - 2a(1+k^2)x + (1-k^2)a^2 + (1-k^2)y^2 = 0.$$

当 $k = 1$ 时得 $x = 0$, 即 Oy 轴. 当 $k \neq 1$ 时, 上述方程可变形为

$$\left[x - \frac{a(1+k^2)}{1-k^2} \right]^2 + y^2 = \left(\frac{2ak}{1-k^2} \right)^2,$$

这是以点 $\left(\frac{a(1+k^2)}{1-k^2}, 0 \right)$ 为圆心, 半径为 $\left| \frac{2ak}{1-k^2} \right|$

的圆族. 当 $0 < k < 1$ 时, 圆分布在右半平面; 当 $k > 1$ 时, 圆分布在左半平面.

如果注意到圆心与原点距离的平方为

$$\left[\frac{a(1+k^2)}{1-k^2} \right]^2 = \frac{a^2[(1-k^2)^2 + 4k^2]}{(1-k^2)^2}$$

$$= a^2 + \left(\frac{2ak}{1-k^2} \right)^2,$$

即等位线圆族与圆 $x^2 + y^2 = a^2$ 在交点处的半径互相垂直 (或圆心距与两圆的半径构成直角三角形), 便知等位线圆族与圆 $x^2 + y^2 = a^2$ 成正交. 如图 6·21 所示.



图 6·21

3164. $z = \operatorname{arctg} \frac{2ay}{x^2 + y^2 - a^2} \quad (a > 0).$

解 等位线为曲线族

$$\frac{2ay}{x^2 + y^2 - a^2} = k,$$

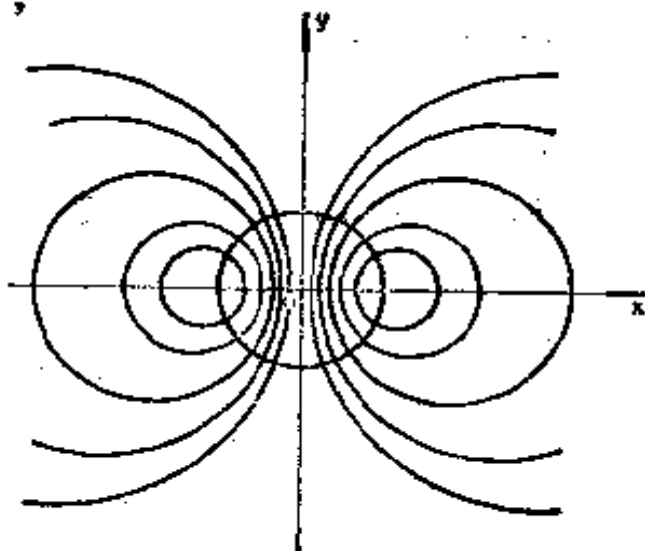
其中 k 为一切实数, 但要除去点 $(-a, 0)$ 及 $(a, 0)$.
 当 $k=0$ 时, $y=0$, 即为 Ox 轴, 但不包含上述两点;
 当 $k \neq 0$ 时, 方程可变形为

$$x^2 + \left(y - \frac{a}{k}\right)^2 = a^2 \left(1 + \frac{1}{k^2}\right),$$

这是圆心在 Oy 轴上且经过点 $(-a, 0)$ 及 $(a, 0)$ 但不包括这两点在内的圆族, 如图 6.22 所示.



图 6.22

3165. $z = \operatorname{sgn}(\sin x \sin y)$.

解 若 $z = 0$, 则 $\sin x \cdot \sin y = 0$, 此即直线族

$$x = m\pi \text{ 和 } y = n\pi \quad (m, n = 0, \pm 1, \pm 2, \dots);$$

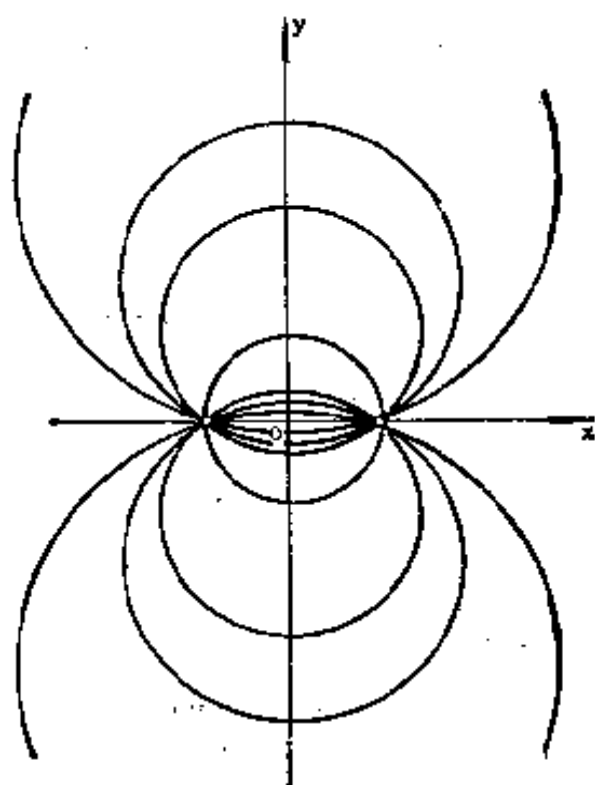
若 $z = -1$ 或 $z = 1$, 则 $\sin x \sin y < 0$ 或 $\sin x \sin y > 0$, 此即正方形系

$$m\pi < x < (m+1)\pi, \quad n\pi < y < (n+1)\pi,$$

其中 $z = (-1)^{m+n}$.

如图 6.23 所示, $z = 0$ 时为图中网格直线; $z = 1$ 为图中带斜线的正方形; $z = -1$ 为图中空白正方形, 但后两者都不包括边界.



图 6.23

求下列函数的等位

面。

3166. $u = x + y + z.$

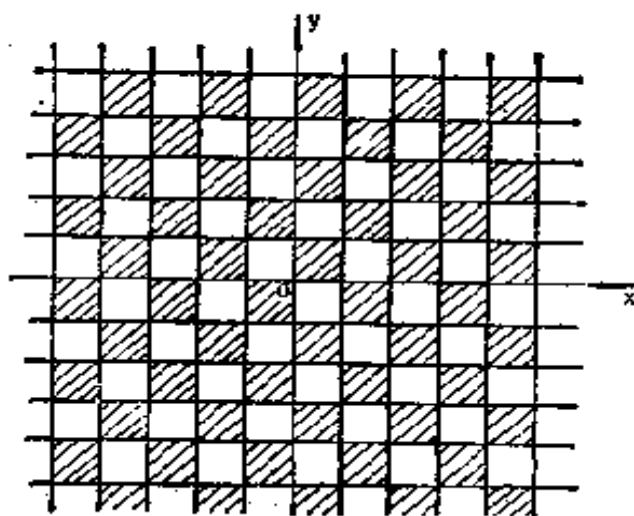
解 等位面为平行平面族

$$x + y + z = k,$$

其中 k 为一切实数。

3167. $u = x^2 + y^2 + z^2.$

解 等位面为中心在原点的同心球族

$$x^2 + y^2 + z^2 = a^2 \quad (a \geq 0),$$

其中当 $a = 0$ 时即为原点。

3168. $u = x^2 + y^2 - z^2.$

解 当 $u = 0$ 时等位面为圆锥 $x^2 + y^2 - z^2 = 0$; 当 $u > 0$ 时等位面为单叶双曲面族 $x^2 + y^2 - z^2 = a^2$ ($a > 0$); 当 $u < 0$ 时等位面为双叶双曲面族 $-x^2 - y^2 + z^2 = a^2$ ($a > 0$).

3169. $u = (x + y)^2 + z^2.$

解 等位面为曲面族

$$(x + y)^2 + z^2 = a^2 \quad (a \geq 0).$$

当 $a = 0$ 时为 $x + y = 0$ 和 $z = 0$. 当 $a > 0$ 时作坐标变换

$$\begin{cases} x' = x \cos \frac{\pi}{4} + y \sin \frac{\pi}{4} = \frac{\sqrt{2}}{2}(x + y), \\ y' = -x \sin \frac{\pi}{4} + y \cos \frac{\pi}{4} = \frac{\sqrt{2}}{2}(-x + y), \\ z' = z, \end{cases}$$

这是旋转变换。在新坐标系中原等位面方程转化为

$$2x'^2 + z'^2 = a^2,$$

即

$$\frac{x'^2}{\frac{a^2}{2}} + \frac{z'^2}{a^2} = 1,$$

这是以 y' 轴为公共轴的椭圆柱面, 母线的方向平行于 y' 轴, 准线为 $y' = 0$ 平面上的椭圆

$$\frac{x'^2}{\frac{a^2}{2}} + \frac{z'^2}{a^2} = 1,$$

长半轴为 a (z' 轴方向), 短半轴为 $\frac{a}{\sqrt{2}}$ (x' 轴方向)。

y' 轴在新系 $O-x'y'z'$ 中的方程为

$$\begin{cases} x' = 0, \\ z' = 0, \end{cases}$$

而在旧系 $O-xyz$ 中的方程为

$$\begin{cases} x + y = 0, \\ z = 0, \end{cases}$$

即为所求的椭圆柱面族的公共对称轴。

3170. $u = \operatorname{sgn} \sin(x^2 + y^2 + z^2)$.

解 当 $u = 0$ 时等位面为球心在原点的同心球族

$$x^2 + y^2 + z^2 = n\pi \quad (n = 0, 1, 2, \dots).$$

当 $u = -1$ 或 $u = 1$ 时等位面为球层族

$$n\pi < x^2 + y^2 + z^2 < (n+1)\pi \quad (n = 0, 1, 2, \dots),$$

其中 $u = (-1)^n$.

根据曲面的已知方程研究其性质:

3171. $z = f(y - ax)$.

解 引入参数 t, s , 将曲面方程 $z = f(y - ax)$ 表成参数方程

$$\begin{cases} x = t, \\ y = at + s, \\ z = f(s). \end{cases}$$

今固定 s , 得到以 t 为参数的直线方程, 其方向数为 $1, a, 0$. 因此, 曲面为以 $1, a, 0$ 为母线方向的一个柱面. 令 $t = 0$, 可得

$$\begin{cases} x = 0, \\ y = s, \\ z = f(s), \end{cases} \quad \text{或} \quad \begin{cases} x = 0, \\ z = f(y), \end{cases}$$

这是 $x = 0$ 平面上的一条曲线, 也是柱面

$$z = f(y - ax)$$

的一条准线.

3172. $z = f(\sqrt{x^2 + y^2})$.

解 这是绕 Oz 轴旋转的旋转曲面的标准形式. 令 $y = 0$, 得曲线

$$\begin{cases} y = 0, \\ z = f(x) \quad (x \geq 0), \end{cases}$$

它是旋转曲面的一条母线.

3173. $z = xf\left(\frac{y}{x}\right)$.

解 引入参数 t, s , 将曲面方程 $z = xf\left(\frac{y}{x}\right)$ 表成参数方程

$$\begin{cases} x = t, \\ y = st (t \neq 0), \\ z = tf(s). \end{cases}$$

今固定 s , 这是以 t 为参数的一条过原点的直线. 因此, 所给曲面为顶点在原点的一锥面, 但不包括原点在内. 令 $t=1$, 得曲线

$$\begin{cases} x = 1, \\ y = s, \\ z = f(s), \end{cases} \quad \text{或} \quad \begin{cases} x = 1, \\ z = f(y), \end{cases}$$

这是 $x=1$ 平面上的一条曲线, 也是锥面 $z = xf\left(\frac{y}{x}\right)$ 的一条准线.

3174⁺. $z = f\left(\frac{y}{x}\right)$.

解 引入参数 t, s , 将曲面方程 $z = f\left(\frac{y}{x}\right)$ 表成参数方程

$$\begin{cases} x = t, \\ y = st, \\ z = f(s). \end{cases}$$

* 题号右上角“+”号表示题解答案与原习题集中译本所附答案不一致, 以后不再说明. 中译本基本是按俄文第二版翻译的. 俄文第二版中有一些错误已在俄文第三版中改正.

今固定 s , 这是一条过点 $(0, 0, f(s))$ 的直线, 方向数为 $1, s, 0$. 因此, 它与 Oz 轴垂直, 与 Oxy 平面平行, 且其方向与 s 有关. 从而得知, 曲面 $z = f\left(\frac{y}{x}\right)$ 表示一个直纹面. 一般说来, 它既不是柱面, 又不是锥面. 令 $t = 1$, 得到直纹面的一条准线

$$\begin{cases} x = 1, \\ z = f(y). \end{cases}$$

从此曲线上每一点引一条与 Oz 轴垂直且相交的直线. 这样的直线的全体, 便构成由 $z = f\left(\frac{y}{x}\right)$ 所表示的直纹面.

3175. 作出函数

$$F(t) = f(\cos t, \sin t)$$

的图形, 式中

$$f(x, y) = \begin{cases} 1, & \text{若 } y \geq x, \\ 0, & \text{若 } y < x. \end{cases}$$

解 按题设, 当 $\sin t \geq \cos t$, 即 $\frac{\pi}{4} + 2k\pi \leq t \leq \frac{5\pi}{4} + 2k\pi$ ($k = 0, \pm 1, \pm 2, \dots$) 时, $F(t) = 1$; 而当



图 6.24

$\sin t < \cos t$, 即 $-\frac{3}{4}\pi + 2k\pi < t < \frac{\pi}{4} + 2k\pi$ 时, $F(t) = 0$. 如图 6.24 所示.

3176. 若

$$f(x, y) = \frac{2xy}{x^2 + y^2},$$

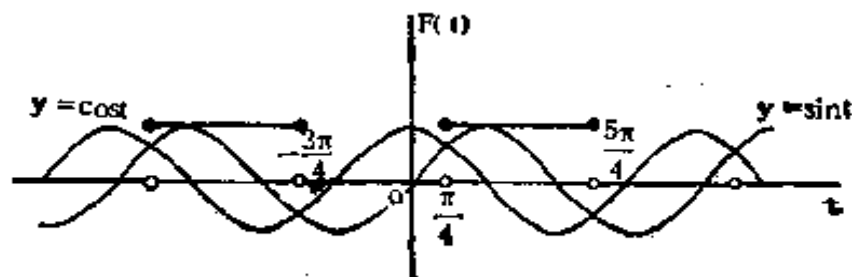
求 $f(1, \frac{y}{x})$.

$$\text{解 } f(1, \frac{y}{x}) = \frac{2 \cdot 1 \cdot \frac{y}{x}}{1 + (\frac{y}{x})^2} = \frac{2xy}{x^2 + y^2} = f(x, y).$$

3177. 若

$$f(\frac{y}{x}) = \frac{\sqrt{x^2 + y^2}}{x} \quad (x > 0),$$

求 $f(x)$.

$$\text{解 } \text{由 } f(\frac{y}{x}) = \sqrt{1 + (\frac{y}{x})^2} \text{ 知 } f(x) = \sqrt{1 + x^2}.$$

3178. 设

$$z = \sqrt{y} + f(\sqrt{x} - 1).$$

若当 $y=1$ 时 $z=x$, 求函数 f 和 z .

解 因为当 $y=1$ 时 $z=x$, 所以

$$\begin{aligned} f(\sqrt{x} - 1) &= x - 1 = (\sqrt{x} - 1)(\sqrt{x} + 1) \\ &= (\sqrt{x} - 1)[(\sqrt{x} - 1) + 2], \end{aligned}$$

从而得

$$f(t) = t(t+2) = t^2 + 2t,$$

且

$$z = \sqrt{y} + x - 1 \quad (x > 0).$$

3179. 设

$$z = x + y + f(x - y).$$

若当 $y=0$ 时, $z=x^2$, 求函数 f 及 z .

解 因为当 $y=0$ 时 $z=x^2$, 所以

$$x^2 = x + f(x),$$

即

$$f(x) = x^2 - x,$$

且

$$z = x + y + (x - y)^2 - (x - y) = 2y + (x - y)^2.$$

3180. 若 $f(x + y, \frac{y}{x}) = x^2 - y^2$, 求 $f(x, y)$.

解 因为

$$f(x + y, \frac{y}{x}) = x^2 - y^2 = (x + y)(x - y)$$

$$= (x + y)^2 \frac{x - y}{x + y} = (x + y)^2 \frac{1 - \frac{y}{x}}{1 + \frac{y}{x}},$$

所以

$$f(x, y) = x^2 \frac{1 - y}{1 + y}.$$

3181. 证明: 对于函数

$$f(x, y) = \frac{x - y}{x + y}$$

有

$$\lim_{x \rightarrow 0} \left\{ \lim_{y \rightarrow 0} f(x, y) \right\} = 1; \quad \lim_{y \rightarrow 0} \left\{ \lim_{x \rightarrow 0} f(x, y) \right\} = -1,$$

从而 $\lim_{\substack{x \rightarrow 0 \\ y \rightarrow 0}} f(x, y)$ 不存在.

$$\text{证} \quad \lim_{x \rightarrow 0} \left\{ \lim_{y \rightarrow 0} f(x, y) \right\} = \lim_{x \rightarrow 0} \left\{ \lim_{y \rightarrow 0} \frac{x-y}{x+y} \right\} = \lim_{x \rightarrow 0} \frac{x}{x} = 1,$$

$$\begin{aligned} \lim_{y \rightarrow 0} \left\{ \lim_{x \rightarrow 0} f(x, y) \right\} &= \lim_{y \rightarrow 0} \left\{ \lim_{x \rightarrow 0} \frac{x-y}{x+y} \right\} \\ &= \lim_{y \rightarrow 0} \frac{-y}{y} = -1. \end{aligned}$$

由于两个单极限都存在，而累次极限不等，故 $\lim_{\substack{x \rightarrow 0 \\ y \rightarrow 0}} f(x, y)$ 不存在.

3182. 证明：对于函数

$$f(x, y) = \frac{x^2 y^2}{x^2 y^2 + (x-y)^2}$$

有

$$\lim_{x \rightarrow 0} \left\{ \lim_{y \rightarrow 0} f(x, y) \right\} = \lim_{x \rightarrow 0} \left\{ \lim_{y \rightarrow 0} f(x, y) \right\} = 0,$$

然而 $\lim_{\substack{x \rightarrow 0 \\ y \rightarrow 0}} f(x, y)$ 不存在.

$$\begin{aligned} \text{证} \quad \lim_{x \rightarrow 0} \left\{ \lim_{y \rightarrow 0} f(x, y) \right\} &= \lim_{x \rightarrow 0} \left\{ \lim_{y \rightarrow 0} \frac{x^2 y^2}{x^2 y^2 + (x-y)^2} \right\} \\ &= \lim_{x \rightarrow 0} 0 = 0, \end{aligned}$$

$$\lim_{y \rightarrow 0} \left\{ \lim_{x \rightarrow 0} f(x, y) \right\} = \lim_{y \rightarrow 0} \left\{ \lim_{x \rightarrow 0} \frac{x^2 y^2}{x^2 y^2 + (x-y)^2} \right\}$$

$$= \lim_{y \rightarrow 0} 0 = 0.$$

如果按 $y = kx \rightarrow 0$ 的方向取极限, 则有

$$\lim_{\substack{y=kx \\ x \rightarrow 0}} f(x, y) = \lim_{x \rightarrow 0} \frac{x^4 k^2}{x^4 k^2 + x^2 (1-k)^2}.$$

特别地, 分别取 $k=0$ 及 $k=1$, 便得到不同的极限 0 及 1. 因此, $\lim_{\substack{x \rightarrow 0 \\ y \rightarrow 0}} f(x, y)$ 不存在.

3183. 证明: 对于函数

$$f(x, y) = (x+y) \sin \frac{1}{x} \sin \frac{1}{y}$$

累次极限 $\lim_{x \rightarrow 0} \left\{ \lim_{y \rightarrow 0} f(x, y) \right\}$ 和 $\lim_{y \rightarrow 0} \left\{ \lim_{x \rightarrow 0} f(x, y) \right\}$ 不存在, 然而 $\lim_{\substack{x \rightarrow 0 \\ y \rightarrow 0}} f(x, y) = 0$.

证 由不等式

$$0 \leq \left| (x+y) \sin \frac{1}{x} \sin \frac{1}{y} \right| \leq |x+y| \leq |x| + |y|$$

知 $\lim_{\substack{x \rightarrow 0 \\ y \rightarrow 0}} f(x, y) = 0$.

但当 $x \neq \frac{1}{k\pi}$, $y \rightarrow 0$ 时, $(x+y) \sin \frac{1}{x} \sin \frac{1}{y}$ 的极限不存在, 因此累次极限 $\lim_{x \rightarrow 0} \left\{ \lim_{y \rightarrow 0} f(x, y) \right\}$ 不存在. 同法可证累次极限 $\lim_{y \rightarrow 0} \left\{ \lim_{x \rightarrow 0} f(x, y) \right\}$ 也不存在.

3184. 求 $\lim_{x \rightarrow a} \left\{ \lim_{y \rightarrow b} f(x, y) \right\}$ 及 $\lim_{y \rightarrow b} \left\{ \lim_{x \rightarrow a} f(x, y) \right\}$, 设:

$$(a) f(x, y) = \frac{x^2 + y^2}{x^2 + y^4}, \quad a = \infty, \quad b = \infty;$$

$$(b) f(x, y) = \frac{x^y}{1 + x^y}, \quad a = +\infty, \quad b = +0;$$

$$(B) f(x, y) = \sin \frac{\pi x}{2x + y}, \quad a = \infty, \quad b = \infty;$$

$$(r) f(x, y) = \frac{1}{xy} \operatorname{tg} \frac{xy}{1 + xy}, \quad a = 0, \quad b = \infty;$$

$$(A) f(x, y) = \log_x(x + y), \quad a = 1, \quad b = 0.$$

$$\text{解 (a)} \quad \lim_{x \rightarrow \infty} \left\{ \lim_{y \rightarrow \infty} f(x, y) \right\} = \lim_{x \rightarrow \infty} \left\{ \lim_{y \rightarrow \infty} \frac{x^2 + y^2}{x^2 + y^4} \right\} \\ = \lim_{x \rightarrow \infty} 0 = 0,$$

$$\lim_{y \rightarrow \infty} \left\{ \lim_{x \rightarrow \infty} f(x, y) \right\} = \lim_{y \rightarrow \infty} \left\{ \lim_{x \rightarrow \infty} \frac{x^2 + y^2}{x^2 + y^4} \right\} \\ = \lim_{y \rightarrow \infty} 1 = 1;$$

$$(b) \quad \lim_{x \rightarrow +\infty} \left\{ \lim_{y \rightarrow +0} f(x, y) \right\} = \lim_{x \rightarrow +\infty} \left\{ \lim_{y \rightarrow +0} \frac{x^y}{1 + x^y} \right\}$$

$$= \lim_{x \rightarrow +\infty} \frac{1}{2} = \frac{1}{2},$$

$$\lim_{y \rightarrow +0} \left\{ \lim_{x \rightarrow +\infty} f(x, y) \right\} = \lim_{y \rightarrow +0} \left\{ \lim_{x \rightarrow +\infty} \frac{x^y}{1 + x^y} \right\}$$

$$= \lim_{y \rightarrow +0} 1 = 1;$$

$$(B) \quad \lim_{x \rightarrow \infty} \left\{ \lim_{y \rightarrow \infty} f(x, y) \right\} = \lim_{x \rightarrow \infty} \left\{ \lim_{y \rightarrow \infty} \sin \frac{\pi x}{2x + y} \right\}$$

$$= \lim_{x \rightarrow \infty} 0 = 0,$$

$$\begin{aligned} \lim_{y \rightarrow \infty} \left\{ \lim_{x \rightarrow \infty} f(x, y) \right\} &= \lim_{y \rightarrow \infty} \left\{ \lim_{x \rightarrow \infty} \sin \frac{\pi x}{2x + y} \right\} \\ &= \lim_{y \rightarrow \infty} 1 = 1; \end{aligned}$$

$$\begin{aligned} (\Gamma) \quad \lim_{x \rightarrow 0} \left\{ \lim_{y \rightarrow \infty} f(x, y) \right\} &= \lim_{x \rightarrow 0} \left\{ \lim_{y \rightarrow \infty} \frac{1}{xy} \operatorname{tg} \frac{xy}{1 + xy} \right\} \\ &= \lim_{x \rightarrow 0} \left\{ \lim_{y \rightarrow \infty} \frac{1}{xy} \cdot \lim_{y \rightarrow \infty} \operatorname{tg} \frac{xy}{1 + xy} \right\} \\ &= \lim_{x \rightarrow 0} \left\{ 0 \cdot \operatorname{tg} 1 \right\} = 0, \end{aligned}$$

$$\begin{aligned} \lim_{y \rightarrow \infty} \left\{ \lim_{x \rightarrow 0} f(x, y) \right\} &= \lim_{y \rightarrow \infty} \left\{ \lim_{x \rightarrow 0} \frac{1}{xy} \operatorname{tg} \frac{xy}{1 + xy} \right\} \\ &= \lim_{y \rightarrow \infty} \left\{ \lim_{x \rightarrow 0} \frac{\operatorname{tg} \frac{xy}{1 + xy}}{\frac{xy}{1 + xy}} \cdot \lim_{x \rightarrow 0} \frac{1}{1 + xy} \right\} \\ &= \lim_{y \rightarrow \infty} 1 = 1; \end{aligned}$$

$$\begin{aligned} (\Delta) \quad \lim_{x \rightarrow 1} \left\{ \lim_{y \rightarrow 0} f(x, y) \right\} &= \lim_{x \rightarrow 1} \left\{ \lim_{y \rightarrow 0} \log_x(x + y) \right\} \\ &= \lim_{x \rightarrow 1} \left\{ \lim_{y \rightarrow 0} \frac{\ln(x + y)}{\ln x} \right\} = \lim_{x \rightarrow 1} \frac{\ln x}{\ln x} = 1, \end{aligned}$$

$$\lim_{y \rightarrow 0} \left\{ \lim_{x \rightarrow 1} f(x, y) \right\} = \lim_{y \rightarrow 0} \left\{ \lim_{x \rightarrow 1} \frac{\ln(x + y)}{\ln x} \right\} = \infty.$$

求下列极限:

$$3185. \lim_{\substack{x \rightarrow \infty \\ y \rightarrow \infty}} \frac{x+y}{x^2-xy+y^2}.$$

解 由不等式 $x^2+y^2 \geq 2|xy|$ 得

$$\begin{aligned} 0 &\leq \left| \frac{x+y}{x^2-xy+y^2} \right| \leq \frac{|x+y|}{x^2+y^2-|xy|} \leq \frac{|x+y|}{|xy|} \\ &\leq \frac{1}{|x|} + \frac{1}{|y|}, \end{aligned}$$

而 $\lim_{\substack{x \rightarrow \infty \\ y \rightarrow \infty}} \left(\frac{1}{|x|} + \frac{1}{|y|} \right) = 0$, 故有

$$\lim_{\substack{x \rightarrow \infty \\ y \rightarrow \infty}} \frac{x+y}{x^2-xy+y^2} = 0.$$

$$3186. \lim_{\substack{x \rightarrow \infty \\ y \rightarrow \infty}} \frac{x^2+y^2}{x^4+y^4}.$$

解 由不等式

$$0 \leq \frac{x^2+y^2}{x^4+y^4} \leq \frac{x^2+y^2}{2x^2y^2} = \frac{1}{2} \left(\frac{1}{x^2} + \frac{1}{y^2} \right)$$

及 $\lim_{\substack{x \rightarrow \infty \\ y \rightarrow \infty}} \frac{1}{2} \left(\frac{1}{x^2} + \frac{1}{y^2} \right) = 0$, 即得

$$\lim_{\substack{x \rightarrow \infty \\ y \rightarrow \infty}} \frac{x^2+y^2}{x^4+y^4} = 0.$$

$$3187. \lim_{\substack{x \rightarrow 0 \\ y \rightarrow a}} \frac{\sin xy}{x}.$$

解 $\lim_{\substack{x \rightarrow 0 \\ y \rightarrow a}} \frac{\sin xy}{x} = \lim_{\substack{x \rightarrow 0 \\ y \rightarrow a}} \left(\frac{\sin xy}{xy} \cdot y \right) = a.$

$$3188. \lim_{\substack{x \rightarrow +\infty \\ y \rightarrow +\infty}} (x^2 + y^2)e^{-(x+y)},$$

$$\text{解 } \lim_{\substack{x \rightarrow +\infty \\ y \rightarrow +\infty}} (x^2 + y^2)e^{-(x+y)}$$

$$= \lim_{\substack{x \rightarrow +\infty \\ y \rightarrow +\infty}} \left[\frac{(x+y)^2}{e^{x+y}} - 2 \cdot \frac{x}{e^x} \cdot \frac{y}{e^y} \right] = 0^*.$$

*) 利用 564 题的结果.

$$3189. \lim_{\substack{x \rightarrow +\infty \\ y \rightarrow +\infty}} \left(\frac{xy}{x^2 + y^2} \right)^{x^2}.$$

解 由不等式

$$0 \leq \left(\frac{xy}{x^2 + y^2} \right)^{x^2} \leq \left(\frac{1}{2} \right)^{x^2}$$

及 $\lim_{x \rightarrow +\infty} \left(\frac{1}{2} \right)^{x^2} = 0$, 即得

$$\lim_{\substack{x \rightarrow +\infty \\ y \rightarrow +\infty}} \left(\frac{xy}{x^2 + y^2} \right)^{x^2} = 0.$$

$$3190. \lim_{\substack{x \rightarrow 0 \\ y \rightarrow 0}} (x^2 + y^2)^{x^2 y^2}.$$

解 由不等式

$$|x^2 y^2 \ln(x^2 + y^2)| \leq \frac{(x^2 + y^2)^2}{4} |\ln(x^2 + y^2)|$$

及 $\lim_{\substack{x \rightarrow 0 \\ y \rightarrow 0}} \frac{(x^2 + y^2)^2}{4} \ln(x^2 + y^2) = \lim_{t \rightarrow 0} \frac{1}{4} t^2 \ln t = 0$, 即得

$$\lim_{\substack{x \rightarrow 0 \\ y \rightarrow 0}} (x^2 + y^2)^{x^2 y^2} = \lim_{\substack{x \rightarrow 0 \\ y \rightarrow 0}} e^{x^2 y^2 \ln(x^2 + y^2)} = e^0 = 1.$$

$$3191. \lim_{\substack{x \rightarrow \infty \\ y \rightarrow a}} \left(1 + \frac{1}{x}\right)^{\frac{x^2}{x+y}}$$

$$\begin{aligned} \text{解} \quad \lim_{\substack{x \rightarrow \infty \\ y \rightarrow a}} \left(1 + \frac{1}{x}\right)^{\frac{x^2}{x+y}} &= \lim_{\substack{x \rightarrow \infty \\ y \rightarrow a}} \left(1 + \frac{1}{x}\right)^{x \cdot \frac{x}{x+y}} \\ &= \lim_{\substack{x \rightarrow \infty \\ y \rightarrow a}} e^{[x \ln(1 + \frac{1}{x})] \cdot \frac{x}{x+y}} \\ &= e^{\left[\lim_{x \rightarrow \infty} x \ln\left(1 + \frac{1}{x}\right)\right] \cdot \left[\lim_{\substack{x \rightarrow \infty \\ y \rightarrow a}} \frac{x}{x+y}\right]} = e^{1 \cdot 1} = e. \end{aligned}$$

$$3192. \lim_{\substack{x \rightarrow 1 \\ y \rightarrow 0}} \frac{\ln(x + e^y)}{\sqrt{x^2 + y^2}}$$

$$\text{解} \quad \lim_{\substack{x \rightarrow 1 \\ y \rightarrow 0}} \frac{\ln(x + e^y)}{\sqrt{x^2 + y^2}} = \frac{\ln(1 + e^0)}{1} = \ln 2.$$

3193⁺. 若 $x = \rho \cos \varphi$, $y = \rho \sin \varphi$, 问下列极限沿怎样的方向 φ 有确定的极限值存在:

$$(a) \lim_{\rho \rightarrow +0} e^{\frac{x}{x^2 + y^2}}; \quad (b) \lim_{\rho \rightarrow +\infty} e^{x^2 - y^2} \cdot \sin 2xy.$$

$$\text{解} \quad (a) \lim_{\rho \rightarrow +0} e^{\frac{x}{x^2 + y^2}} = \lim_{\rho \rightarrow +0} e^{\frac{\cos \varphi}{\rho}}$$

$$= \begin{cases} 0, & \text{当 } \cos \varphi < 0; \\ 1, & \text{当 } \cos \varphi = 0; \\ +\infty, & \text{当 } \cos \varphi > 0. \end{cases}$$

于是, 仅当 $\cos \varphi \leq 0$ 即 $\frac{\pi}{2} \leq \varphi \leq \frac{3\pi}{2}$ 时, 所给的极限

才有确定的值.

$$(6) e^{x^2-y^2} \sin 2xy = e^{\rho^2 \cos 2\varphi} \sin(\rho^2 \sin 2\varphi).$$

当 $\rho \rightarrow +\infty$ 时, $\sin(\rho^2 \sin 2\varphi)$ 有界, 除 $\varphi = \frac{k\pi}{2}$

($k=0, 1, 2, 3$) 外无极限, 且

$$\lim_{\rho \rightarrow +\infty} e^{\rho^2 \cos 2\varphi} = \begin{cases} 0, & \text{当 } \cos 2\varphi < 0; \\ 1, & \text{当 } \cos 2\varphi = 0; \\ +\infty, & \text{当 } \cos 2\varphi > 0. \end{cases}$$

于是, 仅当 $\frac{\pi}{4} < \varphi < \frac{3\pi}{4}$ 及 $\frac{5\pi}{4} < \varphi < \frac{7\pi}{4}$ 以及 $\varphi=0, \varphi$

$=\pi$ 时才有确定的极限.

求下列函数的不连续点:

$$3194. u = \frac{1}{\sqrt{x^2 + y^2}}.$$

解 函数 $u = \frac{1}{\sqrt{x^2 + y^2}}$ 在点 $(0, 0)$ 无定义, 故原点

$(0, 0)$ 为此函数的不连续点. 以下各题类似情况, 不再说明.

$$3195. u = \frac{xy}{x+y}.$$

解 直线 $x+y=0$ 上的一切点均为 $u = \frac{xy}{x+y}$ 的不连续点.

$$3196. u = \frac{x+y}{x^3+y^3}.$$

解 对于任意不等于零的实数 a , 有

$$\lim_{\substack{x \rightarrow a \\ y \rightarrow -a}} \frac{x+y}{x^3+y^3} = \lim_{\substack{x \rightarrow a \\ y \rightarrow -a}} \frac{1}{x^2-xy+y^2} = \frac{1}{3a^2}.$$

于是，对于直线 $x+y=0$ 上除去原点 O 外的一切点均为可移去的不连续点。而原点 $O(0,0)$ 为无穷型不连续点。

3197. $u = \sin \frac{1}{xy}.$

解 $xy=0$ 上的一切点即两坐标轴上的诸点均为 $u = \sin \frac{1}{xy}$ 的不连续点。

3198. $u = \frac{1}{\sin x \sin y}.$

解 直线 $x=m\pi$ 及 $y=n\pi$ ($m, n=0, \pm 1, \pm 2, \dots$) 上的各点均为 $u = \frac{1}{\sin x \sin y}$ 的不连续点。

3199. $u = \ln(1-x^2-y^2).$

解 圆周 $x^2+y^2=1$ 上各点是 $u = \ln(1-x^2-y^2)$ 的不连续点。

3200. $u = \frac{1}{xyz}.$

解 坐标面： $x=0, y=0, z=0$ 上各点均为 $u = \frac{1}{xyz}$ 的不连续点。

3201. $u = \ln \frac{1}{\sqrt{(x-a)^2 + (y-b)^2 + (z-c)^2}}.$

解 点 (a, b, c) 为 $u = \ln \frac{1}{\sqrt{(x-a)^2 + (y-b)^2 + (z-c)^2}}$ 的不连续点.

3202. 证明: 函数

$$f(x, y) = \begin{cases} \frac{2xy}{x^2 + y^2}, & \text{若 } x^2 + y^2 \neq 0; \\ 0, & \text{若 } x^2 + y^2 = 0, \end{cases}$$

分别对于每一个变数 x 或 y (当另一变数的值固定时)是连续的, 但并非对这些变数的总体是连续的.

证 先固定 $y = a \neq 0$, 则得 x 的函数

$$g(x) = f(x, a) = \begin{cases} \frac{2ax}{x^2 + a^2}, & x \neq 0, \\ 0, & x = 0, \end{cases}$$

即 $g(x) = \frac{2ax}{x^2 + a^2}$ ($-\infty < x < +\infty$), 它是处处有定义的有理函数. 又当 $y = 0$ 时, $f(x, 0) \equiv 0$, 它显然是连续的. 于是, 当变数 y 固定时, 函数 $f(x, y)$ 对于变数 x 是连续的. 同理可证, 当变数 x 固定时, 函数 $f(x, y)$ 对于变数 y 是连续的.

作为二元函数, $f(x, y)$ 虽在除点 $(0, 0)$ 外的各点均连续, 但在点 $(0, 0)$ 不连续. 事实上, 当动点 $P(x, y)$ 沿射线 $y = kx$ 趋于原点时, 有

$$\lim_{\substack{x \rightarrow 0 \\ (y=kx)}} f(x, y) = \lim_{x \rightarrow 0} \frac{2kx^2}{x^2(1+k^2)} = \frac{2k}{1+k^2},$$

对于不同的 k 可得不同的极限值, 从而知 $\lim_{\substack{x \rightarrow 0 \\ y \rightarrow 0}} f(x, y)$ 不存在. 因此, 函数 $f(x, y)$ 在原点不是二元连续

的.

3203. 证明: 函数

$$f(x, y) = \begin{cases} \frac{x^2 y}{x^4 + y^2}, & \text{若 } x^2 + y^2 \neq 0, \\ 0, & \text{若 } x^2 + y^2 = 0, \end{cases}$$

在点 $O(0, 0)$ 沿着过此点的每一射线

$$x = t \cos \alpha, \quad y = t \sin \alpha \quad (0 \leq t < +\infty)$$

连续, 即

$$\lim_{t \rightarrow 0} f(t \cos \alpha, t \sin \alpha) = f(0, 0);$$

但此函数在点 $(0, 0)$ 并非连续的.

证 当 $\sin \alpha = 0$ 时, $\cos \alpha = 1$ 或 -1 . 于是, 当 $t \neq 0$

时, $f(t \cos \alpha, t \sin \alpha) = \frac{t^2 \cdot 0}{t^4 + 0} = 0$, 而 $f(0, 0) = 0$,

故有 $\lim_{t \rightarrow 0} f(t \cos \alpha, t \sin \alpha) = f(0, 0)$.

当 $\sin \alpha \neq 0$ 时, 有

$$\begin{aligned} \lim_{t \rightarrow 0} f(t \cos \alpha, t \sin \alpha) &= \lim_{t \rightarrow 0} \frac{t^3 \cos^2 \alpha \sin \alpha}{t^4 \cos^4 \alpha + t^2 \sin^2 \alpha} \\ &= \lim_{t \rightarrow 0} \frac{t \cos^2 \alpha \sin \alpha}{t^2 \cos^4 \alpha + \sin^2 \alpha} = \frac{0}{0 + \sin^2 \alpha} = 0, \end{aligned}$$

故 $\lim_{t \rightarrow 0} f(t \cos \alpha, t \sin \alpha) = f(0, 0)$.

其次, 设动点 $P(x, y)$ 沿抛物线 $y = x^2$ 趋于原点, 得

$$\lim_{\substack{x \rightarrow 0 \\ (y=x^2)}} f(x, y) = \lim_{x \rightarrow 0} \frac{x^4}{x^4 + x^4} = \frac{1}{2} \neq f(0, 0).$$

因此, 函数 $f(x, y)$ 在点 $(0, 0)$ 不连续.

3204. 证明: 函数

$$f(x, y) = x \sin \frac{1}{y}, \text{ 若 } y \neq 0 \text{ 及 } f(x, 0) = 0$$

的不连续点的集合不是封闭的.

证 当 $y_0 \neq 0$ 时, 函数 $f(x, y)$ 在点 (x_0, y_0) 显见是连续的, 即 $f(x, y)$ 在除去 Ox 轴以外的一切点均连续.

又因 $|f(x, y) - f(0, 0)| = |f(x, y)| \leq |x|$, 故知 $f(x, y)$ 在原点也是连续的.

考虑当 $x_0 \neq 0$ 时, 对于点 $(x_0, 0)$, 由于极限

$$\lim_{y \rightarrow 0} f(x_0, y) = \lim_{y \rightarrow 0} x_0 \sin \frac{1}{y}$$

不存在, 故知 $f(x, y)$ 在点 $(x_0, 0)$ 不连续.

这样, 我们证明了, 函数 $f(x, y)$ 的全部不连续点为 Ox 轴上除去原点外的一切点. 显然, 原点是不连续点集合的一个聚点, 但它本身却不是 $f(x, y)$ 的不连续点. 因此, $f(x, y)$ 的不连续点的集合不是封闭的.

3205. 证明: 若函数 $f(x, y)$ 在某域 G 内对变数 x 是连续的, 而关于 x 对变数 y 是一致连续的, 则此函数在所考虑的域内是连续的.

证 任意固定一点 $P_0(x_0, y_0) \in G$.

由于 $f(x, y)$ 关于 x 对变数 y 一致连续, 故对任给的 $\varepsilon > 0$, 存在 $\delta_1 = \delta_1(\varepsilon) > 0$, 使当 $(x, y') \in G$, $(x, y'') \in G$ 且 $|y' - y''| < \delta_1$ 时, 就有

$$|f(x, y') - f(x, y'')| < \frac{\varepsilon}{2}.$$

又因 $f(x, y)$ 在点 (x_0, y_0) 关于变数 x 是连续的, 故对上述的 ε , 存在 $\delta_2 > 0$, 使当 $|x - x_0| < \delta_2$ 时, 就有

$$|f(x, y_0) - f(x_0, y_0)| < \frac{\varepsilon}{2}.$$

取 $0 < \delta \leq \min\{\delta_1, \delta_2\}$, 并使点 (x_0, y_0) 的 δ 邻域全部包含在区域 G 内, 则当点 $P(x, y)$ 属于点 (x_0, y_0) 的 δ 邻域, 即 $|PP_0| < \delta$ 时,

$$|x - x_0| < \delta \leq \delta_2, \quad |y - y_0| < \delta \leq \delta_1.$$

从而有

$$\begin{aligned} |f(x, y) - f(x_0, y_0)| &\leq |f(x, y) - f(x, y_0)| \\ &\quad + |f(x, y_0) - f(x_0, y_0)| \\ &< \frac{\varepsilon}{2} + \frac{\varepsilon}{2} = \varepsilon. \end{aligned}$$

因此, $f(x, y)$ 在点 P_0 连续. 由 P_0 的任意性知, 函数 $f(x, y)$ 在 G 内是连续的.

3206. 证明: 若在某域 G 内函数 $f(x, y)$ 对变数 x 是连续的, 并满足对变数 y 的里普什兹条件, 即

$$|f(x, y') - f(x, y'')| \leq L|y' - y''|,$$

式中 $(x, y') \in G, (x, y'') \in G$ 而 L 为常数, 则此函数在已知域内是连续的.

证 由于 $f(x, y)$ 在 G 内满足对 y 的里普什兹条件, 故知 $f(x, y)$ 在 G 内关于 x 对变数 y 是一致连续的. 因此, 由 3205 题的结果, 即知 $f(x, y)$ 在 G 内是连续的.

3207. 证明: 若函数 $f(x, y)$ 分别地对每一个变数 x 和 y 是

连续的并对于其中的一个是单调的, 则此函数对两个变数的总体是连续的 (尤格定理)

证 不妨设 $f(x, y)$ 关于 x 是单调的.

设 (x_0, y_0) 为函数 $f(x, y)$ 的定义域 G 内的任一点. 由于 $f(x, y)$ 关于 x 连续, 故对任给的 $\varepsilon > 0$, 存在 $\delta_1 > 0$ (假定 δ_1 足够小, 使我们所考虑的点都落在 G 内), 使当 $|x - x_0| \leq \delta_1$ 时, 就有

$$|f(x, y_0) - f(x_0, y_0)| < \frac{\varepsilon}{2}.$$

对于点 $(x_0 - \delta_1, y_0)$ 及 $(x_0 + \delta_1, y_0)$, 由于 $f(x, y)$ 关于 y 连续, 故对上述的 ε , 存在 $\delta_2 > 0$ (也要求 δ_2 足够小, 使所考虑的点落在 G 内), 使当 $|y - y_0| \leq \delta_2$ 时, 就有

$$|f(x_0 - \delta_1, y) - f(x_0 - \delta_1, y_0)| < \frac{\varepsilon}{2}$$

及

$$|f(x_0 + \delta_1, y) - f(x_0 + \delta_1, y_0)| < \frac{\varepsilon}{2}.$$

令 $\delta = \min\{\delta_1, \delta_2\}$, 则当 $|\Delta x| < \delta, |\Delta y| < \delta$ 时, 由于 $f(x, y)$ 关于 x 单调, 故有

$$\begin{aligned} & |f(x_0 + \Delta x, y_0 + \Delta y) - f(x_0, y_0)| \\ & \leq \max\{|f(x_0 + \delta_1, y_0 + \Delta y) - f(x_0, y_0)|, \\ & |f(x_0 - \delta_1, y_0 + \Delta y) - f(x_0, y_0)|\}. \end{aligned}$$

但是

$$\begin{aligned} & |f(x_0 \pm \delta_1, y_0 + \Delta y) - f(x_0, y_0)| \\ & \leq |f(x_0 \pm \delta_1, y_0 + \Delta y) - f(x_0 \pm \delta_1, y_0)| \\ & \quad + |f(x_0 \pm \delta_1, y_0) - f(x_0, y_0)| \end{aligned}$$

$$< \frac{\varepsilon}{2} + \frac{\varepsilon}{2} = \varepsilon,$$

故当 $|\Delta x| < \delta, |\Delta y| < \delta$ 时, 就有

$$|f(x_0 + \Delta x, y_0 + \Delta y) - f(x_0, y_0)| < \varepsilon,$$

即 $f(x, y)$ 在点 (x_0, y_0) 是连续的. 由点 (x_0, y_0) 的任意性知, $f(x, y)$ 是 G 内的二元连续函数.

3208. 设函数 $f(x, y)$ 于域 $a \leq x \leq A, b \leq y \leq B$ 上是连续的, 而函数叙列 $\varphi_n(x)$ ($n = 1, 2, \dots$) 在 $[a, A]$ 上一致收敛并满足条件 $b \leq \varphi_n(x) \leq B$. 证明: 函数叙列

$$F_n(x) = f[x, \varphi_n(x)] \quad (n = 1, 2, \dots)$$

也在 $[a, A]$ 上一致收敛.

证 由于 $b \leq \varphi_n(x) \leq B$, 故 $F_n(x) = f[x, \varphi_n(x)]$ 有意义.

由题设 $f(x, y)$ 在域 $a \leq x \leq A, b \leq y \leq B$ 上连续, 故在此域上一致连续, 即对任给的 $\varepsilon > 0$, 存在 $\delta = \delta(\varepsilon) > 0$, 使对于此域中的任意两点 $(x_1, y_1), (x_2, y_2)$, 只要 $|x_1 - x_2| < \delta, |y_1 - y_2| < \delta$ 时, 就有

$$|f(x_1, y_1) - f(x_2, y_2)| < \varepsilon.$$

特别地, 当 $|y_1 - y_2| < \delta$ 时, 对于一切的 $x \in (a, A)$, 均有

$$|f(x, y_1) - f(x, y_2)| < \varepsilon.$$

对于上述的 $\delta > 0$, 因为 $\varphi_n(x)$ 在 (a, A) 上一致收敛, 故存在自然数 N , 使当 $m > N, n > N$ 时, 对于一切的 $x \in (a, A)$, 均有

$$|\varphi_n(x) - \varphi_m(x)| < \delta.$$

于是, 对任给的 $\varepsilon > 0$, 存在自然数 N , 使当 $m >$

N , $n > N$ 时, 对于一切的 $x \in (a, A)$, 均有

$$\begin{aligned} |F_n(x) - F_m(x)| &= \\ &= |f(x, \varphi_n(x)) - f(x, \varphi_m(x))| < \varepsilon. \end{aligned}$$

因此, $F_n(x)$ 在 (a, A) 上一致收敛.

3209. 设: 1) 函数 $f(x, y)$ 于域 $R(a < x < A; b < y < B)$ 内是连续的; 2) 函数 $\varphi(x)$ 于区间 (a, A) 内连续并有属于区间 (b, B) 内的值. 证明: 函数

$$F(x) = f(x, \varphi(x))$$

于区间 (a, A) 内是连续的.

证 设点 (x_0, y_0) 为域 R 中的任一点. 由题设知函数 $f(x, y)$ 于域 R 中连续, 故对任给的 $\varepsilon > 0$, 存在 $\delta > 0$, 使当 $|x - x_0| < \delta$, $|y - y_0| < \delta$ ($(x, y) \in R$) 时, 就有

$$|f(x, y) - f(x_0, y_0)| < \varepsilon.$$

再由 $\varphi(x)$ 在 (a, A) 中的连续性可知, 对上述的 $\delta > 0$, 存在 $\eta > 0$ (可取 $\eta < \delta$), 使当 $|x - x_0| < \eta$ ($x \in (a, A)$) 时, 恒有

$$|\varphi(x) - \varphi(x_0)| = |y - y_0| < \delta.$$

于是,

$$|f(x, \varphi(x)) - f(x_0, \varphi(x_0))| < \varepsilon,$$

即

$$|F(x) - F(x_0)| < \varepsilon.$$

因此, $F(x)$ 在点 x_0 处连续. 由 x_0 的任意性知函数 $F(x)$ 在 (a, A) 内是连续的.

3210. 设: 1) 函数 $f(x, y)$ 于域 $R(a < x < A; b < y < B)$ 内是连续的; 2) 函数 $x = \varphi(u, v)$ 及 $y = \psi(u, v)$ 于域 R'

$(a' < u < A'; b' < v < B')$ 内是连续的并有分别属于区间 (a, A) 和 (b, B) 的值. 证明: 函数

$$F(u, v) = f(\varphi(u, v), \psi(u, v))$$

于域 R' 内连续.

证 以下假定所取的 δ 或 η 足够小, 使点的 δ 或 η 邻域都在所给的域内.

设点 (x_0, y_0) 为域 R 中的任一点. 由于 $f(x, y)$ 在 R 内连续, 故对任给的 $\varepsilon > 0$, 存在 $\delta > 0$, 使当 $|x - x_0| < \delta, |y - y_0| < \delta$ 时, 就有

$$|f(x, y) - f(x_0, y_0)| < \varepsilon.$$

再由 φ 及 ψ 的连续性知, 对于上述的 δ , 存在 $\eta > 0$, 使当 $|u - u_0| < \eta, |v - v_0| < \eta$ 时, 就有

$$|x - x_0| < \delta, |y - y_0| < \delta,$$

其中 $x_0 = \varphi(u_0, v_0), y_0 = \psi(u_0, v_0)$.

于是, 对任给的 $\varepsilon > 0$, 存在 $\eta > 0$, 使当 $|u - u_0| < \eta, |v - v_0| < \eta$ 时, 就有

$$|f(\varphi(u, v), \psi(u, v)) - f(\varphi(u_0, v_0), \psi(u_0, v_0))| < \varepsilon,$$

即

$$|F(u, v) - F(u_0, v_0)| < \varepsilon.$$

因此, $F(u, v)$ 在点 (u_0, v_0) 连续, 由 (u_0, v_0) 的任意性知, 函数 $F(u, v)$ 于域 R' 内连续.

§2. 偏导函数. 多变量函数的微分

1° 偏导函数 若所论及的多变数的函数的一切偏导函

数是连续的, 则微分的结果与微分的次序无关.

2° 多变量函数的微分 若自变数 x, y, z 的函数 $f(x, y, z)$ 的全增量可写为下形

$$\Delta f(x, y, z) = A\Delta x + B\Delta y + C\Delta z + o(\rho),$$

式中 A, B, C 与 $\Delta x, \Delta y, \Delta z$ 无关而 $\rho = \sqrt{(\Delta x)^2 + (\Delta y)^2 + (\Delta z)^2}$, 则称函数 $f(x, y, z)$ 可微分, 而增量的线性主部 $A\Delta x + B\Delta y + C\Delta z$ 等于

$$df(x, y, z) = f'_x(x, y, z)dx + f'_y(x, y, z)dy + f'_z(x, y, z)dz, \quad (1)$$

(其中 $dx = \Delta x, dy = \Delta y, dz = \Delta z$) 称为此函数的微分.

当变数 x, y, z 为其他自变数的可微分的函数时, 公式(1)仍有其意义.

若 x, y, z 为自变数, 则对于高阶的微分, 有符号公式

$$d^2f(x, y, z) = \left(dx \frac{\partial}{\partial x} + dy \frac{\partial}{\partial y} + dz \frac{\partial}{\partial z} \right)^2 f(x, y, z).$$

3° 复合函数的导函数 若 $w = f(x, y, z)$, 其中 $x = \varphi(u, v), y = \psi(u, v), z = \chi(u, v)$ 且函数 φ, ψ, χ 可微分, 则

$$\frac{\partial w}{\partial u} = \frac{\partial w}{\partial x} \frac{\partial x}{\partial u} + \frac{\partial w}{\partial y} \frac{\partial y}{\partial u} + \frac{\partial w}{\partial z} \frac{\partial z}{\partial u},$$

$$\frac{\partial w}{\partial v} = \frac{\partial w}{\partial x} \frac{\partial x}{\partial v} + \frac{\partial w}{\partial y} \frac{\partial y}{\partial v} + \frac{\partial w}{\partial z} \frac{\partial z}{\partial v}.$$

计算函数 w 的二阶导函数时最好用下列符号公式:

$$\frac{\partial^2 w}{\partial u^2} = \left(P_1 \frac{\partial}{\partial x} + Q_1 \frac{\partial}{\partial y} + R_1 \frac{\partial}{\partial z} \right)^2 w + \frac{\partial P_1}{\partial u} \frac{\partial w}{\partial x}$$

$$+ \frac{\partial Q_1}{\partial u} \frac{\partial w}{\partial y} + \frac{\partial R_1}{\partial u} \frac{\partial w}{\partial z}$$

$$\text{及 } \frac{\partial^2 w}{\partial u \partial v} = \left(P_1 \frac{\partial}{\partial x} + Q_1 \frac{\partial}{\partial y} + R_1 \frac{\partial}{\partial z} \right) \left(P_2 \frac{\partial}{\partial x} + Q_2 \frac{\partial}{\partial y} + R_2 \frac{\partial}{\partial z} \right) w + \frac{\partial P_1}{\partial v} \frac{\partial w}{\partial x} + \frac{\partial Q_1}{\partial v} \frac{\partial w}{\partial y} + \frac{\partial R_1}{\partial v} \frac{\partial w}{\partial z},$$

$$\text{其中 } P_1 = \frac{\partial x}{\partial u}, Q_1 = \frac{\partial y}{\partial u}, R_1 = \frac{\partial z}{\partial u}$$

$$\text{及 } R_2 = \frac{\partial x}{\partial v}, Q_2 = \frac{\partial y}{\partial v}, R_2 = \frac{\partial z}{\partial v}.$$

4° 在已知方向上的导函数 若用方向余弦 $\{\cos \alpha, \cos \beta, \cos \gamma\}$ 表 $Oxyz$ 空间内的方向 l , 且函数 $u = f(x, y, z)$ 可微分, 则沿方向 l 的导函数按下式来计算

$$\frac{\partial u}{\partial l} = \frac{\partial u}{\partial x} \cos \alpha + \frac{\partial u}{\partial y} \cos \beta + \frac{\partial u}{\partial z} \cos \gamma.$$

在已知点函数增加最迅速的速度之大小与方向用 向量
——函数的梯度

$$\text{grad } u = \frac{\partial u}{\partial x} \vec{i} + \frac{\partial u}{\partial y} \vec{j} + \frac{\partial u}{\partial z} \vec{k}$$

来表示, 它的大小等于

$$|\text{grad } u| = \sqrt{\left(\frac{\partial u}{\partial x}\right)^2 + \left(\frac{\partial u}{\partial y}\right)^2 + \left(\frac{\partial u}{\partial z}\right)^2}.$$

3211. 证明:

$$f'_x(x, b) = \frac{d}{dx}[f(x, b)].$$

证 令 $\varphi(x) = f(x, b)$, 则

$$\begin{aligned} \frac{d}{dx}[f(x, b)] &= \varphi'(x) = \lim_{\Delta x \rightarrow 0} \frac{\varphi(x + \Delta x) - \varphi(x)}{\Delta x} \\ &= \lim_{\Delta x \rightarrow 0} \frac{f(x + \Delta x, b) - f(x, b)}{\Delta x} = f'_x(x, b). \end{aligned}$$

注 在求某一固定点的导数及微分时, 用本题的结果常可减少运算量. 在本节中, 我们就多次利用本题的结果来简化运算.

3212. 设:

$$f(x, y) = x + (y-1) \arcsin \sqrt{\frac{x}{y}},$$

求 $f'_x(x, 1)$.

解 由于 $f(x, 1) = x$, 故 $f'_x(x, 1) = 1$.

求下列函数的一阶和二阶偏导函数:

3213. $u = x^4 + y^4 - 4x^2y^2$.

$$\text{解 } \frac{\partial u}{\partial x} = 4x^3 - 8xy^2, \quad \frac{\partial u}{\partial y} = 4y^3 - 8x^2y,$$

$$\frac{\partial^2 u}{\partial x^2} = 12x^2 - 8y^2, \quad \frac{\partial^2 u}{\partial y^2} = 12y^2 - 8x^2,$$

$$\frac{\partial^2 u}{\partial x \partial y} = \frac{\partial^2 u}{\partial y \partial x} = -16xy^{*}).$$

*) 以下各题不再写 $\frac{\partial^2 u}{\partial y \partial x} = \frac{\partial^2 u}{\partial x \partial y}$, 而仅写 $\frac{\partial^2 u}{\partial x \partial y}$, 因为当它们连续时是相等的, 并且在今后各题中均把

$\frac{\partial^2 u}{\partial x \partial y}$ 理解为 $\frac{\partial}{\partial y} \left(\frac{\partial u}{\partial x} \right)$.

3214. $u = xy + \frac{x}{y}$.

解 $\frac{\partial u}{\partial x} = y + \frac{1}{y}$, $\frac{\partial u}{\partial y} = x - \frac{x}{y^2}$,

$$\frac{\partial^2 u}{\partial x^2} = 0, \quad \frac{\partial^2 u}{\partial y^2} = \frac{2x}{y^3}, \quad \frac{\partial^2 u}{\partial x \partial y} = 1 - \frac{1}{y^2}.$$

3215. $u = \frac{x}{y^2}$.

解 $\frac{\partial u}{\partial x} = \frac{1}{y^2}$, $\frac{\partial u}{\partial y} = -\frac{2x}{y^3}$,

$$\frac{\partial^2 u}{\partial x^2} = 0, \quad \frac{\partial^2 u}{\partial y^2} = \frac{6x}{y^4}, \quad \frac{\partial^2 u}{\partial x \partial y} = -\frac{2}{y^3}.$$

3216. $u = \frac{x}{\sqrt{x^2 + y^2}}$.

解 $\frac{\partial u}{\partial x} = \frac{1}{\sqrt{x^2 + y^2}} - \frac{2x \cdot x}{2(x^2 + y^2)^{\frac{3}{2}}} = \frac{y^2}{(x^2 + y^2)^{\frac{3}{2}}}$,

$$\frac{\partial u}{\partial y} = -\frac{xy}{(x^2 + y^2)^{\frac{3}{2}}}$$

$$\frac{\partial^2 u}{\partial x^2} = -\frac{3}{2} y^2 \cdot \frac{2x}{(x^2 + y^2)^{\frac{5}{2}}} = -\frac{3xy^2}{(x^2 + y^2)^{\frac{5}{2}}}$$

$$\frac{\partial^2 u}{\partial y^2} = -\frac{x}{(x^2 + y^2)^{\frac{3}{2}}} + \frac{3}{2} xy \cdot \frac{2y}{(x^2 + y^2)^{\frac{5}{2}}}$$

$$= \frac{x(2y^2 - x^2)}{(x^2 + y^2)^{\frac{5}{2}}},$$

$$\frac{\partial^2 u}{\partial x \partial y} = \frac{\partial}{\partial y} \left[\frac{y^2}{(x^2 + y^2)^{\frac{3}{2}}} \right]$$

$$= \frac{2y}{(x^2 + y^2)^{\frac{3}{2}}} - \frac{3y^3}{(x^2 + y^2)^{\frac{5}{2}}} = \frac{y(2x^2 - y^2)}{(x^2 + y^2)^{\frac{5}{2}}}.$$

3217. $u = x \sin(x + y).$

解 $\frac{\partial u}{\partial x} = \sin(x + y) + x \cos(x + y),$

$$\frac{\partial u}{\partial y} = x \cos(x + y),$$

$$\begin{aligned} \frac{\partial^2 u}{\partial x^2} &= \cos(x + y) + \cos(x + y) - x \sin(x + y) \\ &= 2 \cos(x + y) - x \sin(x + y), \end{aligned}$$

$$\frac{\partial^2 u}{\partial y^2} = -x \sin(x + y),$$

$$\frac{\partial^2 u}{\partial x \partial y} = \cos(x + y) - x \sin(x + y).$$

3218. $u = \frac{\cos x^2}{y}.$

解 $\frac{\partial u}{\partial x} = -\frac{2x \sin x^2}{y}, \quad \frac{\partial u}{\partial y} = -\frac{\cos x^2}{y^2},$

$$\frac{\partial^2 u}{\partial x^2} = -\frac{2 \sin x^2 + 4x^2 \cos x^2}{y},$$

$$\frac{\partial^2 u}{\partial y^2} = \frac{2 \cos x^2}{y^3}$$

$$\frac{\partial^2 u}{\partial x \partial y} = \frac{2x \sin x^2}{y^2}$$

3219. $u = \operatorname{tg} \frac{x^2}{y}$.

解 $\frac{\partial u}{\partial x} = \frac{2x}{y} \sec^2 \frac{x^2}{y}, \quad \frac{\partial u}{\partial y} = -\frac{x^2}{y^2} \sec^2 \frac{x^2}{y},$

$$\frac{\partial^2 u}{\partial x^2} = \frac{2}{y} \sec^2 \frac{x^2}{y} + \frac{2x}{y} \cdot 2 \sec^2 \frac{x^2}{y} \cdot \operatorname{tg} \frac{x^2}{y} \cdot \frac{2x}{y}$$

$$= \frac{2}{y} \sec^2 \frac{x^2}{y} + \frac{8x^2}{y^2} \sec^2 \frac{x^2}{y} \operatorname{tg} \frac{x^2}{y},$$

$$\frac{\partial^2 u}{\partial y^2} = \frac{2x^2}{y^3} \sec^2 \frac{x^2}{y} + \frac{2x^4}{y^4} \sec^2 \frac{x^2}{y} \operatorname{tg} \frac{x^2}{y},$$

$$\frac{\partial^2 u}{\partial x \partial y} = -\frac{2x}{y^2} \sec^2 \frac{x^2}{y} - \frac{4x^3}{y^3} \sec^2 \frac{x^2}{y} \operatorname{tg} \frac{x^2}{y}$$

3220. $u = x^y$.

解 由 $u = x^y = e^{y \ln x}$ 即得

$$\frac{\partial u}{\partial x} = yx^{y-1}, \quad \frac{\partial u}{\partial y} = e^{y \ln x} \cdot \ln x = x^y \ln x,$$

$$\frac{\partial^2 u}{\partial x^2} = y(y-1)x^{y-2}, \quad \frac{\partial^2 u}{\partial y^2} = x^y \ln^2 x,$$

$$\frac{\partial^2 u}{\partial x \partial y} = x^{y-1} + yx^{y-1} \ln x$$

$$= x^{y-1}(1+y \ln x) \quad (x > 0).$$

3221. $u = \ln(x + y^2).$

解 $\frac{\partial u}{\partial x} = \frac{1}{x + y^2}, \quad \frac{\partial u}{\partial y} = \frac{2y}{x + y^2},$

$$\frac{\partial^2 u}{\partial x^2} = -\frac{1}{(x + y^2)^2},$$

$$\frac{\partial^2 u}{\partial y^2} = \frac{2}{x + y^2} - \frac{2y \cdot 2y}{(x + y^2)^2} = \frac{2(x - y^2)}{(x + y^2)^2},$$

$$\frac{\partial^2 u}{\partial x \partial y} = -\frac{2y}{(x + y^2)^2}.$$

3222. $u = \arctg \frac{y}{x}.$

解 $\frac{\partial u}{\partial x} = \frac{1}{1 + \left(\frac{y}{x}\right)^2} \left(-\frac{y}{x^2}\right) = -\frac{y}{x^2 + y^2},$

$$\frac{\partial u}{\partial y} = \frac{1}{1 + \left(\frac{y}{x}\right)^2} \cdot \frac{1}{x} = \frac{x}{x^2 + y^2},$$

$$\frac{\partial^2 u}{\partial x^2} = \frac{2xy}{(x^2 + y^2)^2}, \quad \frac{\partial^2 u}{\partial y^2} = -\frac{2xy}{(x^2 + y^2)^2},$$

$$\frac{\partial^2 u}{\partial x \partial y} = -\frac{1}{x^2 + y^2} + \frac{y \cdot 2y}{(x^2 + y^2)^2}$$

$$= -\frac{x^2 - y^2}{(x^2 + y^2)^2}.$$

3223. $u = \arctg \frac{x + y}{1 - xy}.$

解 由776题知

$$\operatorname{arc\,tg} \frac{x+y}{1-xy} = \operatorname{arc\,tg} x + \operatorname{arc\,tg} y - \varepsilon\pi,$$

其中 $\varepsilon = 0, 1$ 或 -1 . 于是,

$$\frac{\partial u}{\partial x} = \frac{1}{1+x^2}, \quad \frac{\partial u}{\partial y} = \frac{1}{1+y^2},$$

$$\frac{\partial^2 u}{\partial x^2} = -\frac{2x}{(1+x^2)^2}, \quad \frac{\partial^2 u}{\partial y^2} = -\frac{2y}{(1+y^2)^2},$$

$$\frac{\partial^2 u}{\partial x \partial y} = 0.$$

本题如不用776题的结果, 直接求导数也可获解.

例如,

$$\begin{aligned} \frac{\partial u}{\partial x} &= \frac{1}{1 + \left(\frac{x+y}{1-xy}\right)^2} \cdot \frac{1-xy + y(x+y)}{(1-xy)^2} \\ &= \frac{1}{1+x^2}. \end{aligned}$$

3224. $u = \operatorname{arc\,sin} \frac{x}{\sqrt{x^2+y^2}}.$

$$\begin{aligned} \text{解} \quad \frac{\partial u}{\partial x} &= \frac{1}{\sqrt{1 - \frac{x^2}{x^2+y^2}}} \left(\frac{x}{\sqrt{x^2+y^2}} \right)' \\ &= \frac{\sqrt{x^2+y^2}}{|y|} \cdot \frac{y^2}{(x^2+y^2)^{\frac{3}{2}}} \quad *) \end{aligned}$$

$$= \frac{|y|}{x^2 + y^2}.$$

$$\frac{\partial u}{\partial y} = \frac{1}{\sqrt{1 - \frac{x^2}{x^2 + y^2}}} \left(\frac{x}{\sqrt{x^2 + y^2}} \right)'$$

$$= \frac{\sqrt{x^2 + y^2}}{|y|} \left[-\frac{xy}{(x^2 + y^2)^{\frac{3}{2}}} \right]^*)$$

$$= -\frac{x}{x^2 + y^2} \cdot \frac{y}{|y|} = -\frac{x \operatorname{sgn} y}{x^2 + y^2},$$

$$\frac{\partial^2 u}{\partial x^2} = -\frac{2x|y|}{(x^2 + y^2)^2},$$

$$\frac{\partial^2 u}{\partial y^2} = \frac{\partial}{\partial y} \left[-\frac{xy}{|y|(x^2 + y^2)} \right]$$

$$= -\frac{x|y|(x^2 + y^2) - xy \left[\frac{|y|}{y}(x^2 + y^2) + 2y|y| \right]}{y^2(x^2 + y^2)^2}$$

$$= \frac{2x|y|}{(x^2 + y^2)^2},$$

$$\frac{\partial^2 u}{\partial x \partial y} = \frac{\frac{|y|}{y}(x^2 + y^2) - 2y|y|}{(x^2 + y^2)^2}$$

$$= \frac{x^2 \operatorname{sgn} y - y|y|}{(x^2 + y^2)^2} = \frac{(x^2 - y^2) \operatorname{sgn} y}{(x^2 + y^2)^2} \quad (y \neq 0).$$

*) 利用3216题的结果.

$$3225. \quad u = \frac{1}{\sqrt{x^2 + y^2 + z^2}}.$$

$$\text{解 } \frac{\partial u}{\partial x} = -\frac{x}{(x^2 + y^2 + z^2)^{\frac{5}{2}}},$$

$$\frac{\partial u}{\partial y} = -\frac{y}{(x^2 + y^2 + z^2)^{\frac{5}{2}}},$$

$$\frac{\partial u}{\partial z} = -\frac{z}{(x^2 + y^2 + z^2)^{\frac{5}{2}}},$$

$$\begin{aligned} \frac{\partial^2 u}{\partial x^2} &= -\frac{1}{(x^2 + y^2 + z^2)^{\frac{5}{2}}} + \frac{3x^2}{(x^2 + y^2 + z^2)^{\frac{7}{2}}} \\ &= \frac{2x^2 - y^2 - z^2}{(x^2 + y^2 + z^2)^{\frac{7}{2}}}, \end{aligned}$$

$$\frac{\partial^2 u}{\partial x \partial y} = \frac{3xy}{(x^2 + y^2 + z^2)^{\frac{7}{2}}}.$$

利用对称性，即得

$$\frac{\partial^2 u}{\partial y^2} = \frac{2y^2 - x^2 - z^2}{(x^2 + y^2 + z^2)^{\frac{7}{2}}}, \quad \frac{\partial^2 u}{\partial z^2} = \frac{2z^2 - x^2 - y^2}{(x^2 + y^2 + z^2)^{\frac{7}{2}}},$$

$$\frac{\partial^2 u}{\partial y \partial z} = \frac{3yz}{(x^2 + y^2 + z^2)^{\frac{7}{2}}},$$

$$\frac{\partial^2 u}{\partial z \partial x} = \frac{3xz}{(x^2 + y^2 + z^2)^{\frac{7}{2}}}.$$

3226. $u = \left(\frac{x}{y}\right)^x.$

解 $u = x^x y^{-x}.$

$$\frac{\partial u}{\partial x} = z x^{z-1} y^{-z} = \frac{z}{x} \left(\frac{x}{y}\right)^z,$$

$$\frac{\partial u}{\partial y} = -z x^z y^{-z-1} = -\frac{z}{y} \left(\frac{x}{y}\right)^z,$$

$$\frac{\partial u}{\partial z} = \left(\frac{x}{y}\right)^z \ln \frac{x}{y},$$

$$\frac{\partial^2 u}{\partial x^2} = z(z-1) x^{z-2} y^{-z} = \frac{z(z-1)}{x^2} \left(\frac{x}{y}\right)^z,$$

$$\frac{\partial^2 u}{\partial y^2} = (-z)(-z-1) x^z y^{-z-2} = \frac{z(z+1)}{y^2} \left(\frac{x}{y}\right)^z,$$

$$\frac{\partial^2 u}{\partial z^2} = \left(\frac{x}{y}\right)^z \ln^2 \frac{x}{y},$$

$$\frac{\partial^2 u}{\partial x \partial y} = \left(\frac{z}{x} u\right)'_y = \frac{z}{x} \left[-\frac{z}{y} \left(\frac{x}{y}\right)^z\right]$$

$$= -\frac{z^2}{xy} \left(\frac{x}{y}\right)^z,$$

$$\frac{\partial^2 u}{\partial y \partial z} = \left(-\frac{z}{y} u\right)'_z = -\frac{z}{y} \left(\frac{x}{y}\right)^z \ln \frac{x}{y} - \frac{1}{y} \left(\frac{x}{y}\right)^z$$

$$= -\frac{1+z \ln \frac{x}{y}}{y} \left(\frac{x}{y}\right)^z,$$

$$\frac{\partial^2 u}{\partial z \partial x} = \left(u \ln \frac{x}{y}\right)'_x = \frac{z}{x} \left(\frac{x}{y}\right)^z \ln \frac{x}{y} + \frac{1}{x} \left(\frac{x}{y}\right)^z$$

$$= \frac{1+z \ln \frac{x}{y}}{x} \left(\frac{x}{y}\right)^z \quad \left(\frac{x}{y} > 0\right).$$

3227. $u = x^{\frac{y}{z}}$.

解 $\frac{\partial u}{\partial x} = \frac{y}{z} x^{\frac{y}{z}-1} = \frac{yu}{xz}$,

$$\frac{\partial u}{\partial y} = \frac{1}{z} x^{\frac{y}{z}} \ln x = \frac{u \ln x}{z},$$

$$\frac{\partial u}{\partial z} = -\frac{y}{z^2} x^{\frac{y}{z}} \ln x = -\frac{yu \ln x}{z^2},$$

$$\frac{\partial^2 u}{\partial x^2} = \frac{xyz \frac{\partial u}{\partial x} - yzu}{x^2 z^2} = \frac{y(y-z)u}{x^2 z^2},$$

$$\frac{\partial^2 u}{\partial y^2} = \frac{\ln x}{z} \frac{\partial u}{\partial y} = \frac{u \ln^2 x}{z^2},$$

$$\begin{aligned} \frac{\partial^2 u}{\partial z^2} &= -y \ln x \cdot \left[\frac{z^2 \frac{\partial u}{\partial z} - 2uz}{z^4} \right] \\ &= \frac{yu \ln x \cdot (2z + y \ln x)}{z^4}, \end{aligned}$$

$$\frac{\partial^2 u}{\partial x \partial y} = \frac{1}{xz} \left(u + y \frac{\partial u}{\partial y} \right) = \frac{u(z + y \ln x)}{xz^2},$$

$$\begin{aligned} \frac{\partial^2 u}{\partial y \partial z} &= \ln x \cdot \left(\frac{1}{z} \frac{\partial u}{\partial z} - \frac{u}{z^2} \right) \\ &= -\frac{u \ln x \cdot (z + y \ln x)}{z^3}, \end{aligned}$$

$$\frac{\partial^2 u}{\partial z \partial x} = -\frac{y}{z^2} \left(\ln x \frac{\partial u}{\partial x} + \frac{u}{x} \right) = -\frac{yu(z + y \ln x)}{xy^3}.$$

$$3228. \quad u = x^{y^z}$$

$$\text{解} \quad \frac{\partial u}{\partial x} = y^z x^{y^z-1} = \frac{u y^z}{x}$$

$$\frac{\partial u}{\partial y} = z y^{z-1} x^{y^z} \ln x = z u y^{z-1} \ln x,$$

$$\frac{\partial u}{\partial z} = x^{y^z} y^z \ln x \cdot \ln y = u y^z \ln x \cdot \ln y,$$

$$\frac{\partial^2 u}{\partial x^2} = y^z \left(-\frac{u}{x^2} + \frac{1}{x} \frac{\partial u}{\partial x} \right) = \frac{u y^z (y^z - 1)}{x^2},$$

$$\begin{aligned} \frac{\partial^2 u}{\partial y^2} &= z \ln x \cdot \left[y^{z-1} \frac{\partial u}{\partial y} + (z-1) y^{z-2} u \right] \\ &= u z y^{z-2} \ln x \cdot (z y^z \ln x + z - 1), \end{aligned}$$

$$\begin{aligned} \frac{\partial^2 u}{\partial z^2} &= \left(y^z \frac{\partial u}{\partial z} + u y^z \ln y \right) \ln x \cdot \ln y \\ &= u y^z \ln x \cdot \ln^2 y \cdot (1 + y^z \ln x), \end{aligned}$$

$$\begin{aligned} \frac{\partial^2 u}{\partial x \partial y} &= \frac{1}{x} \left(y^z \frac{\partial u}{\partial y} + u z y^{z-1} \right) \\ &= \frac{u z y^{z-1} (y^z \ln x + 1)}{x}, \end{aligned}$$

$$\begin{aligned} \frac{\partial^2 u}{\partial y \partial z} &= \left(y^{z-1} u + u z y^{z-1} \ln y + z y^{z-1} \frac{\partial u}{\partial z} \right) \ln x \\ &= u y^{z-1} \ln x \cdot (1 + z \ln y \cdot (1 + y^z \ln x)), \end{aligned}$$

$$\begin{aligned}\frac{\partial^2 u}{\partial z \partial x} &= y^x \ln y \cdot \left(\frac{\partial u}{\partial x} \ln x + \frac{u}{x} \right) \\ &= \frac{u y^x \ln y \cdot (y^x \ln x + 1)}{x} \quad (x > 0, y > 0).\end{aligned}$$

3229. 设 (a) $u = x^2 - 2xy - 3y^2$; (b) $u = x^{y^2}$; (B) $u =$

$\arccos \sqrt{\frac{x}{y}}$, 验证等式

$$\frac{\partial^2 u}{\partial x \partial y} = \frac{\partial^2 u}{\partial y \partial x}.$$

证 (a) $\frac{\partial u}{\partial x} = 2x - 2y, \frac{\partial u}{\partial y} = -2x - 6y,$

$$\frac{\partial^2 u}{\partial x \partial y} = -2, \frac{\partial^2 u}{\partial y \partial x} = -2,$$

于是, $\frac{\partial^2 u}{\partial x \partial y} = \frac{\partial^2 u}{\partial y \partial x}.$

(b) $\frac{\partial u}{\partial x} = y^2 x^{y^2-1}, \frac{\partial u}{\partial y} = 2yx^{y^2} \ln x \quad (x > 0),$

$$\frac{\partial^2 u}{\partial x \partial y} = 2yx^{y^2-1} + 2y^3 x^{y^2-1} \ln x,$$

$$\frac{\partial^2 u}{\partial y \partial x} = 2y^3 x^{y^2-1} \ln x + 2yx^{y^2-1},$$

于是, $\frac{\partial^2 u}{\partial x \partial y} = \frac{\partial^2 u}{\partial y \partial x}.$

(B) 当 $0 < x \leq y$ 时, 我们有

$$u = \arccos \sqrt{\frac{x}{y}} = \arccos \frac{\sqrt{x}}{\sqrt{y}}.$$

$$\frac{\partial u}{\partial x} = -\frac{1}{\sqrt{1-\frac{x}{y}}} \cdot \frac{1}{2\sqrt{x}\sqrt{y}} = -\frac{1}{2\sqrt{x}(y-x)},$$

$$\frac{\partial u}{\partial y} = -\frac{1}{\sqrt{1-\frac{x}{y}}} \left(-\frac{\sqrt{x}}{2y^{\frac{3}{2}}} \right) = \frac{\sqrt{x}}{2\sqrt{y^2}(y-x)},$$

$$\frac{\partial^2 u}{\partial x \partial y} = \frac{1}{4\sqrt{x}(y-x)^{\frac{3}{2}}},$$

$$\frac{\partial^2 u}{\partial y \partial x} = \frac{1}{4\sqrt{x}\sqrt{y^2}(y-x)} + \frac{\sqrt{x}}{4y(y-x)^{\frac{3}{2}}}$$

$$= \frac{1}{4\sqrt{x}(y-x)^{\frac{3}{2}}},$$

于是, 当 $0 < x \leq y$ 时, 有

$$\frac{\partial^2 u}{\partial x \partial y} = \frac{\partial^2 u}{\partial y \partial x}.$$

$$\text{当 } y \leq x < 0 \text{ 时, } u = \arccos \frac{\sqrt{-x}}{\sqrt{-y}}.$$

$$\frac{\partial u}{\partial x} = -\frac{1}{\sqrt{1-\frac{x}{y}}} \left(-\frac{1}{2\sqrt{-x}\sqrt{-y}} \right)$$

$$= \frac{1}{2\sqrt{-x}\sqrt{x-y}},$$

$$\frac{\partial u}{\partial y} = \frac{1}{\sqrt{1-\frac{x}{y}}} \left[\frac{\sqrt{-x}}{2(-y)^{\frac{3}{2}}} \right] = -\frac{\sqrt{-x}}{2\sqrt{xy^2-y^3}},$$

$$\frac{\partial^2 u}{\partial x \partial y} = \frac{1}{4\sqrt{-x}(x-y)^{\frac{3}{2}}},$$

$$\frac{\partial^2 u}{\partial y \partial x} = \frac{1}{4\sqrt{-x}\sqrt{xy^2-y^3}} + \frac{\sqrt{-x}}{4\sqrt{y^2}(x+y)^{\frac{3}{2}}}$$

$$= \frac{1}{4\sqrt{-x}(x-y)^{\frac{3}{2}}},$$

于是, 当 $y \leq x < 0$ 时, 也有

$$\frac{\partial^2 u}{\partial x \partial y} = \frac{\partial^2 u}{\partial y \partial x}.$$

仔细观察可以看到, 在不同的区域上, 一阶偏导数相差一个符号, 但二阶混合偏导数却是相等的.

3230. 设 $f(x, y) = xy \frac{x^2 - y^2}{x^2 + y^2}$, 若 $x^2 + y^2 \neq 0$ 及 $f(0, 0) =$

0. 证明

$$f''_{xy}(0, 0) \neq f''_{yx}(0, 0).$$

证 由于

$$\lim_{x \rightarrow 0} \frac{f(x, y) - f(0, y)}{x} = \lim_{x \rightarrow 0} \frac{xy \frac{x^2 - y^2}{x^2 + y^2} - 0}{x} = -y,$$

故 $f'_x(0, y) = -y$, 从而

$$f''_{yx}(0, 0) = \left. \frac{d}{dy} [f'_x(0, y)] \right|_{y=0} = -1$$

同法可求得 $f'_y(x, 0) = x$, 从而

$$f''_{yx}(0, 0) = \left. \frac{d}{dx} [f'_y(x, 0)] \right|_{x=0} = 1.$$

于是, $f''_{xy}(0, 0) \neq f''_{yx}(0, 0)$.

3231. 设 $u = f(x, y, z)$ 为 n 次齐次函数, 就下列各题验证关于齐次函数的尤拉定理:

(a) $u = (x - 2y + 3z)^2$; (b) $u = \frac{x}{\sqrt{x^2 + y^2 + z^2}}$;

(B) $u = \left(\frac{x}{y}\right)^{\frac{1}{2}}$.

证 关于 n 次齐次函数的尤拉定理如下:

设 n 次齐次函数 $f(x, y, z)$ * 在域 A 中关于所有变量均有连续偏导函数, 则下述等式成立

$$\begin{aligned} & x f'_x(x, y, z) + y f'_y(x, y, z) + z f'_z(x, y, z) \\ & = n f(x, y, z). \end{aligned}$$

(a) 由于 $(tx - 2ty + 3tz)^2 = t^2 u$, 故 u 为二次齐次函数. 又因

* 为了书写的简便, 在这里我们仅限于讨论三个变量的情形.

$$\frac{\partial u}{\partial x} = 2(x - 2y + 3z), \quad \frac{\partial u}{\partial y} = -4(x - 2y + 3z),$$

$$\frac{\partial u}{\partial z} = 6(x - 2y + 3z),$$

故得

$$x \frac{\partial u}{\partial x} + y \frac{\partial u}{\partial y} + z \frac{\partial u}{\partial z} = (x - 2y + 3z)(2x - 4y + 6z) = 2u,$$

即函数 u 满足尤拉定理.

(6) 由于对任何的 $t > 0$,

$$\frac{tx}{\sqrt{(tx)^2 + (ty)^2 + (tz)^2}} = \frac{x}{\sqrt{x^2 + y^2 + z^2}} = t^0 \cdot u,$$

故 u 为零次齐次函数. 又因

$$\frac{\partial u}{\partial x} = \frac{y^2 + z^2}{(x^2 + y^2 + z^2)^{\frac{3}{2}}}, \quad \frac{\partial u}{\partial y} = -\frac{xy}{(x^2 + y^2 + z^2)^{\frac{3}{2}}},$$

$$\frac{\partial u}{\partial z} = -\frac{xz}{(x^2 + y^2 + z^2)^{\frac{3}{2}}},$$

故得

$$x \frac{\partial u}{\partial x} + y \frac{\partial u}{\partial y} + z \frac{\partial u}{\partial z} = \frac{1}{(x^2 + y^2 + z^2)^{\frac{3}{2}}} (xy^2 + xz^2 - xy^2 - xz^2) = 0 \cdot u,$$

即函数 u 满足尤拉定理.

(B) 由于

$$\left(\frac{tx}{ty}\right)^{\frac{n}{z}} = \left(\frac{x}{y}\right)^{\frac{n}{z}} = t^0 \cdot u \quad (t > 0),$$

故函数 u 为零次齐次函数. 又因

$$\frac{\partial u}{\partial x} = \frac{1}{y} \cdot \frac{y}{z} \left(\frac{x}{y}\right)^{\frac{n}{z}-1} = \frac{yu}{xz},$$

$$\begin{aligned} \frac{\partial u}{\partial y} &= \left(e^{\frac{n}{z} \ln \frac{x}{y}}\right)' \cdot \left(\frac{x}{y}\right)^{\frac{n}{z}} \cdot \left[\frac{1}{z} \ln \frac{x}{y} - \frac{y}{z} \cdot \frac{1}{y}\right] \\ &= \frac{u}{z} \left(\ln \frac{x}{y} - 1\right), \end{aligned}$$

$$\frac{\partial u}{\partial z} = \left(\frac{x}{y}\right)^{\frac{n}{z}} \ln \frac{x}{y} \cdot \left(-\frac{y}{z^2}\right) = -\frac{yu}{z^2} \ln \frac{x}{y},$$

故得

$$\begin{aligned} x \frac{\partial u}{\partial x} + y \frac{\partial u}{\partial y} + z \frac{\partial u}{\partial z} &= x \cdot \frac{yu}{xz} + y \cdot \frac{u}{z} \left(\ln \frac{x}{y} - 1\right) \\ &\quad - z \cdot \frac{yu}{z^2} \ln \frac{x}{y} = 0 \cdot u, \end{aligned}$$

即函数 u 满足尤拉定理.

3232. 证明: 若可微函数 $u = f(x, y, z)$ 满足方程式

$$x \frac{\partial u}{\partial x} + y \frac{\partial u}{\partial y} + z \frac{\partial u}{\partial z} = nu,$$

则它为 n 次齐次函数.

证 任意固定域中一点 (x_0, y_0, z_0) , 考察下面的 t 的函数 ($t > 0$):

$$F(t) = \frac{f(tx_0, ty_0, tz_0)}{t^n},$$

它当 $t > 0$ 时有定义且是可微的。应用复合函数的求导法则，对 t 求导数即得

$$\begin{aligned} F'(t) &= \frac{1}{t^n} \left\{ x_0 f'_x(tx_0, ty_0, tz_0) + y_0 f'_y(tx_0, \right. \\ &\quad \left. ty_0, tz_0) + z_0 f'_z(tx_0, ty_0, tz_0) \right\} \\ &\quad - \frac{n}{t^{n+1}} f(tx_0, ty_0, tz_0) \\ &= \frac{1}{t^{n+1}} \left\{ tx_0 f'_x(tx_0, ty_0, tz_0) + ty_0 \right. \\ &\quad \left. \cdot f'_y(tx_0, ty_0, tz_0) + tz_0 f'_z(tx_0, ty_0, tz_0) \right. \\ &\quad \left. - nf(tx_0, ty_0, tz_0) \right\}, \end{aligned}$$

由于 $tx_0 f'_x(tx_0, ty_0, tz_0) + ty_0 f'_y(tx_0, ty_0, tz_0) + tz_0$

$$\cdot f'_z(tx_0, ty_0, tz_0) = nf(tx_0, ty_0, tz_0),$$

故

$$F'(t) = 0.$$

从而当 $t > 0$ 时， $F(t) = c$ ，其中 c 为常数。现在确定 c 。为此，在定义 $F(t)$ 的等式中令 $t = 1$ ，则得

$$c = f(x_0, y_0, z_0).$$

于是，

$$\bar{F}(t) = \frac{f(tx_0, ty_0, tz_0)}{t^n} = f(x_0, y_0, z_0),$$

即

$$f(tx_0, ty_0, tz_0) = t^n f(x_0, y_0, z_0).$$

上式说明函数 $f(x, y, z)$ 为一个 n 次的齐次函数，这就是所要证明的。

3233. 证明：若 $f(x, y, z)$ 是可微分的 n 次齐次函数，则其偏导函数 $f'_x(x, y, z), f'_y(x, y, z), f'_z(x, y, z)$ 是 $(n-1)$ 次的齐次函数。

证 由等式

$$f(tx, ty, tz) = t^n f(x, y, z)$$

两端分别对 x, y, z 求偏导函数，则得

$$t f'_1(tx, ty, tz) = t^n f'_1(x, y, z),$$

$$t f'_2(tx, ty, tz) = t^n f'_2(x, y, z),$$

$$t f'_3(tx, ty, tz) = t^n f'_3(x, y, z),$$

其中 $f'_1(\cdot, \cdot, \cdot), f'_2(\cdot, \cdot, \cdot), f'_3(\cdot, \cdot, \cdot)$ 分别代表

$f(\cdot, \cdot, \cdot)$ 对第一个，第二个，第三个变量的偏导数。

于是，

$$f'_1(tx, ty, tz) = t^{n-1} f'_1(x, y, z),$$

$$f'_2(tx, ty, tz) = t^{n-1} f'_2(x, y, z),$$

$$f'_3(tx, ty, tz) = t^{n-1} f'_3(x, y, z),$$

即偏导函数 $f'_x(x, y, z)$, $f'_y(x, y, z)$ 及 $f'_z(x, y, z)$

均为 $(n-1)$ 次的齐次函数,

3234. 设 $u = f(x, y, z)$ 是可微分两次的 n 次齐次函数. 证明

$$\left(x \frac{\partial}{\partial x} + y \frac{\partial}{\partial y} + z \frac{\partial}{\partial z}\right)^2 u = n(n-1)u.$$

证 由3233题知: $\frac{\partial u}{\partial x}$, $\frac{\partial u}{\partial y}$ 及 $\frac{\partial u}{\partial z}$ 均为 $(n-1)$ 次齐次函数. 应用尤拉定理, 即得

$$\left(x \frac{\partial}{\partial x} + y \frac{\partial}{\partial y} + z \frac{\partial}{\partial z}\right) \frac{\partial u}{\partial x} = (n-1) \frac{\partial u}{\partial x}, \quad (1)$$

$$\left(x \frac{\partial}{\partial x} + y \frac{\partial}{\partial y} + z \frac{\partial}{\partial z}\right) \frac{\partial u}{\partial y} = (n-1) \frac{\partial u}{\partial y}, \quad (2)$$

$$\left(x \frac{\partial}{\partial x} + y \frac{\partial}{\partial y} + z \frac{\partial}{\partial z}\right) \frac{\partial u}{\partial z} = (n-1) \frac{\partial u}{\partial z}. \quad (3)$$

将(1)式两端乘以 x , (2)式两端乘以 y , (3)式两端乘以 z , 然后相加, 即得

$$\begin{aligned} \left(x \frac{\partial}{\partial x} + y \frac{\partial}{\partial y} + z \frac{\partial}{\partial z}\right)^2 u &= (n-1) \left(x \frac{\partial u}{\partial x} + y \frac{\partial u}{\partial y} \right. \\ &\quad \left. + z \frac{\partial u}{\partial z}\right) = n(n-1)u, \end{aligned}$$

这就是所要证明的等式.

求下列函数的一阶和二阶微分(x, y, z 为自变数):

3235. $u = x^m y^n$.

解 $du = x^{m-1} y^{n-1} (m y dx + n x dy),$
 $d^2 u = m(m-1) x^{m-2} y^n dx^2 + 2mnx^{m-1} y^{n-1} dx dy$
 $+ n(n-1) x^m y^{n-2} dy^2$
 $= x^{m-2} y^{n-2} [m(m-1) y^2 dx^2 + 2mnxy dx dy$
 $+ n(n-1) x^2 dy^2].$

3236. $u = \frac{x}{y}$.

解 $du = \frac{y dx - x dy}{y^2},$
 $d^2 u = \frac{y^2 (dxdy - dx dy) - 2y dy (y dx - x dy)}{y^4}$
 $= -\frac{2}{y^3} (y dx - x dy) dy.$

3237. $u = \sqrt{x^2 + y^2}$.

解 $du = \frac{x dx + y dy}{\sqrt{x^2 + y^2}},$
 $d^2 u = \frac{d(x dx + y dy)}{\sqrt{x^2 + y^2}} + (x dx + y dy)$
 $\cdot d\left(\frac{1}{\sqrt{x^2 + y^2}}\right) = \frac{dx^2 + dy^2}{\sqrt{x^2 + y^2}} - \frac{(x dx + y dy)^2}{(x^2 + y^2)^{\frac{3}{2}}}$
 $= \frac{(y dx - x dy)^2}{(x^2 + y^2)^{\frac{3}{2}}}.$

3238. $u = \ln \sqrt{x^2 + y^2}$.

解 $du = \frac{xdx + ydy}{x^2 + y^2}$,

$$\begin{aligned} d^2u &= \frac{d(xdx + ydy)}{x^2 + y^2} - \frac{2(xdx + ydy)^2}{(x^2 + y^2)^2} \\ &= \frac{dx^2 + dy^2}{x^2 + y^2} - \frac{2(xdx + ydy)^2}{(x^2 + y^2)^2} \\ &= \frac{(y^2 - x^2)(dx^2 - dy^2) - 4xydx dy}{(x^2 + y^2)^2}. \end{aligned}$$

3239. $u = e^{xy}$.

解 $du = e^{xy}(ydx + xdy)$,

$$\begin{aligned} d^2u &= e^{xy}[(ydx + xdy)^2 + 2dxdy] \\ &= e^{xy}[y^2dx^2 + 2(1 + xy)dxdy + x^2dy^2]. \end{aligned}$$

3240. $u = xy + yz + zx$.

解 $du = (y + z)dx + (z + x)dy + (x + y)dz$,

$$d^2u = 2(dxdy + dydz + dzdx).$$

3241. $u = \frac{z}{x^2 + y^2}$.

解 $du = -\frac{2z}{(x^2 + y^2)^2}(xdx + ydy) + \frac{dz}{x^2 + y^2}$

$$= \frac{(x^2 + y^2)dz - 2z(xdx + ydy)}{(x^2 + y^2)^2},$$

$$\begin{aligned} d^2u &= \frac{1}{(x^2 + y^2)^4} \left\{ (x^2 + y^2)^2 [2(xdx + ydy)dz \right. \\ &\quad \left. - 2(xdx + ydy)dz - 2z(dx^2 + dy^2)] \right\} \end{aligned}$$

$$\begin{aligned}
& -4(x^2 + y^2)(xdx + ydy)[(x^2 + y^2)dz \\
& - 2z(xdx + ydy)] \Big\} \\
= & \frac{1}{(x^2 + y^2)^3} \Big\{ 2z[(3x^2 - y^2)dx^2 + 8xydx dy \\
& + (3y^2 - x^2)dy^2] - 4(x^2 + y^2)(xdx + ydy)dz \Big\}.
\end{aligned}$$

3242. 设 $f(x, y, z) = \sqrt[2]{\frac{x}{y}}$, 求 $df(1, 1, 1)$ 及 $d^2f(1, 1, 1)$.

解 本题将采用分别先求一阶及二阶偏导函数, 然后再合成以求一阶及二阶微分的方法. 由于

$$f'_x(x, 1, 1) = 1, \quad f'_x(1, 1, 1) = 1,$$

$$f'_y(1, y, 1) = -\frac{1}{y^2}, \quad f'_y(1, 1, 1) = -1,$$

$$f'_z(1, 1, z) = 0, \quad f'_z(1, 1, 1) = 0,$$

故得

$$df(1, 1, 1) = f'_x(1, 1, 1)dx + f'_y(1, 1, 1)dy$$

$$+ f'_z(1, 1, 1)dz = dx - dy.$$

又因

$$f''_x(x, 1, 1) = 1, \quad f''_{xx}(x, 1, 1) = 0, \quad f''_{xx}(1, 1, 1) = 0,$$

$$f'_x(1, y, 1) = \frac{1}{y}, \quad f''_{xx}(1, y, 1) = -\frac{1}{y^2},$$

$$f''_{xy}(1, 1, 1) = -1,$$

$$f'_x(1, 1, z) = \frac{1}{z}, \quad f''_{xz}(1, 1, z) = -\frac{1}{z^2},$$

$$f''_{zx}(1, 1, 1) = -1,$$

$$f'_y(1, y, 1) = -\frac{1}{y^2}, \quad f''_{yy}(1, y, 1) = \frac{2}{y^3},$$

$$f''_{yy}(1, 1, 1) = 2,$$

$$f'_y(1, 1, z) = -\frac{1}{z}, \quad f''_{yz}(1, 1, z) = \frac{1}{z^2},$$

$$f''_{zy}(1, 1, 1) = 1,$$

$$f'_z(1, 1, z) = 0, \quad f''_{zz}(1, 1, z) = 0, \quad f''_{zz}(1, 1, 1) = 0,$$

故得

$$\begin{aligned} d^2 f(1, 1, 1) &= f''_{xx}(1, 1, 1)dx^2 + f''_{yy}(1, 1, 1)dy^2 \\ &+ f''_{zz}(1, 1, 1)dz^2 + 2f''_{xy}(1, 1, 1)dx dy \\ &+ 2f''_{yz}(1, 1, 1)dy dz + 2f''_{zx}(1, 1, 1)dx dz \\ &= 2dy^2 - 2dx dy + 2dy dz - 2dx dz \\ &= 2(dy - dx)(dy + dz). \end{aligned}$$

3243. 证明: 若

$$u = \sqrt{x^2 + y^2 + z^2},$$

则

$$d^2u \geq 0.$$

证 $du = \frac{xdx + ydy + zdz}{u},$

$$\begin{aligned}d^2u &= \frac{1}{u^2}[u(dx^2 + dy^2 + dz^2) - (xdx \\ &+ ydy + zdz)du] \\ &= \frac{1}{u^3}[(xdy - ydx)^2 + (ydz - zdz)^2 \\ &+ (zdx - xdz)^2].\end{aligned}$$

由于 $u > 0$ (在原点处 du 不存在), 故 $du \geq 0$.

3244. 假定 x, y 的绝对值甚小, 对下列各式推出近似公式,

(a) $(1+x)^m(1+y)^n$; (b) $\ln(1+x) \cdot \ln(1+y)$;

(B) $\text{arc tg } \frac{x+y}{1+xy}$.

解 (a) 设 $f(x, y) = (1+x)^m(1+y)^n$, 则

$$f'_x(x, 0) = m(1+x)^{m-1}, f'_x(0, 0) = m,$$

$$f'_y(0, y) = n(1+y)^{n-1}, f'_y(0, 0) = n.$$

于是,

$$\begin{aligned}f(x, y) &\approx f(0, 0) + f'_x(0, 0)x + f'_y(0, 0)y \\ &= 1 + mx + ny,\end{aligned}$$

即有近似公式

$$(1+x)^m(1+y)^n \approx 1+mx+ny.$$

(6) 设 $f(x, y) = \ln(1+x) \cdot \ln(1+y)$, 则

$$f'_x(x, 0) = 0, f'_x(0, 0) = 0,$$

$$f'_y(0, y) = 0, f'_y(0, 0) = 0,$$

$$f''_{xx}(x, 0) = 0, f''_{xx}(0, 0) = 0,$$

$$f''_{yy}(0, y) = 0, f''_{yy}(0, 0) = 0,$$

$$f''_{xz}(0, y) = \ln(1+y), f''_{xz}(0, y)$$

$$= \frac{1}{1+y}, f''_{xz}(0, 0) = 1.$$

于是,

$$\begin{aligned} f(x, y) &\approx f(0, 0) + f'_x(0, 0)x + f'_y(0, 0)y \\ &+ \frac{1}{2!} \left[f''_{xx}(0, 0)x^2 + 2f''_{xy}(0, 0)xy + f''_{yy}(0, 0)y^2 \right] \\ &= xy, \end{aligned}$$

即有近似公式

$$\ln(1+x) \cdot \ln(1+y) \approx xy.$$

本题如不用求偏导函数的方法, 也可直接获解:

$$\ln(1+x) \cdot \ln(1+y) = [x + o(x)] \cdot [y + o(y)]$$

$\approx xy$.

(B) 设 $f(x, y) = \arctg \frac{x+y}{1+xy}$, 则

$$f'_x(x, 0) = \frac{1}{1+x^2}, \quad f'_x(0, 0) = 1,$$

$$f'_y(0, y) = \frac{1}{1+y^2}, \quad f'_y(0, 0) = 1.$$

于是,

$$f(x, y) \approx f(0, 0) + f'_x(0, 0)x + f'_y(0, 0)y = x + y,$$

即有近似公式

$$\arctg \frac{x+y}{1+xy} \approx x+y.$$

3245. 用微分来代替函数的增量, 近似地计算:

(a) $1.002 \cdot 2.003^2 \cdot 3.004^3$; (b) $\frac{1.03^2}{\sqrt[3]{0.98} \sqrt{1.05^3}}$;

(c) $\sqrt{1.02^3 + 1.97^3}$; (r) $\sin 29^\circ \operatorname{tg} 46^\circ$;

(d) $0.97^{1.05}$.

解 (a) 设 $f(x, y, z) = (1+x)^m(1+y)^n(1+z)^l$, 则当 $|x|, |y|, |z|$ 甚小时, 有近似公式(参阅 3244(a))

$$f(x, y, z) \approx 1 + mx + ny + lz.$$

利用上式即得

$$1.002 \cdot 2.003^2 \cdot 3.004^3 = (1+0.002)$$

$$\cdot 2^2 \left(1 + \frac{0.003}{2}\right)^2 \cdot 3^3 \left(1 + \frac{0.004}{3}\right)^3$$

$$\approx 1 \cdot 2^2 \cdot 3^3 \left(1 + 0.002 + 2 \cdot \frac{0.003}{2} + 3 \cdot \frac{0.004}{3} \right)$$

$$= 108.972;$$

$$(6) \frac{1.03^2}{\sqrt[3]{0.98} \cdot \sqrt[4]{1.05^3}} = (1 + 0.03)^2$$

$$\cdot (1 - 0.02)^{-\frac{1}{3}} (1 + 0.05)^{-\frac{1}{4}}$$

$$\approx 1 + 2 \cdot 0.03 + \left(-\frac{1}{3}\right)(-0.02) + \left(-\frac{1}{4}\right) \cdot 0.05$$

$$\approx 1.054;$$

$$(B) \sqrt{1.02^3 + 1.97^3} = (1.97)^{\frac{3}{2}} \left[1 + \left(\frac{1.02}{1.97}\right)^3 \right]^{\frac{1}{2}}$$

$$= 2^{\frac{3}{2}} \left(1 - \frac{0.03}{2}\right)^{\frac{3}{2}} \left[1 + \left(\frac{1.02}{1.97}\right)^3 \right]^{\frac{1}{2}}$$

$$\approx 2^{\frac{3}{2}} \left[1 + \frac{3}{2} \left(-\frac{0.03}{2}\right) + \frac{1}{2} \left(\frac{1.02}{1.97}\right)^3 \right]$$

$$\approx 2.95;$$

(r) 设 $f(x, y) = \sin x \operatorname{tg} y$, 则有近似公式

$$f(x, y) \approx \sin x_0 \operatorname{tg} y_0 + \cos x_0 \operatorname{tg} y_0 \cdot (x - x_0)$$

$$+ \frac{\sin x_0}{\cos^2 y_0} \cdot (y - y_0).$$

在本题中, 令 $x_0 = \frac{\pi}{6}$, $y_0 = \frac{\pi}{4}$, $x - x_0 = -\frac{\pi}{180}$,

$$y - y_0 = \frac{\pi}{180}, \text{ 即得}$$

$$\sin 29^\circ \operatorname{tg} 46^\circ \approx \sin \frac{\pi}{6} \operatorname{tg} \frac{\pi}{4} + \cos \frac{\pi}{6} \operatorname{tg} \frac{\pi}{4}$$

$$\cdot \left(-\frac{\pi}{180} \right) + \frac{\sin \frac{\pi}{6}}{\cos^2 \frac{\pi}{4}} \left(\frac{\pi}{180} \right)$$

$$\approx 0.502;$$

(A) 设 $f(x, y) = x^y$, 由于

$$f'_x(1, 1) = \frac{d}{dx} f(x, 1) \Big|_{x=1} = 1,$$

$$f'_y(1, 1) = \frac{d}{dy} f(1, y) \Big|_{y=1} = 0,$$

于是, $x^y \approx x$. 所以, 我们有

$$0.97^{1.05} \approx 0.97.$$

3246. 设矩形的边 $x=6$ 米和 $y=8$ 米, 若第一个边增加 2 毫米, 而第二个边减少 5 毫米, 问矩形的对角线和面积变化多少?

解 面积 $A=xy$, 对角线 $l=\sqrt{x^2+y^2}$. 于是,

$$\Delta A \approx ydx + xdy, \quad \Delta l \approx \frac{xdx + ydy}{\sqrt{x^2 + y^2}}.$$

以 $x=6000$, $y=8000$, $dx=2$, $dy=-5$ 代入上述二式, 即得

$$\Delta A \approx 8000 \cdot 2 + 6000 \cdot (-5) = -14000 \text{ (平方毫米)} \\ = -140 \text{ (平方厘米)},$$

$$\Delta l \approx \frac{6000 \cdot 2 + 8000 \cdot (-5)}{\sqrt{6000^2 + 8000^2}} \approx -3 \text{ (毫米)},$$

即对角线减少约 3 毫米，面积减少约 140 平方厘米。

3247. 扇形的中心角 $\alpha = 60^\circ$ 增加 $\Delta\alpha = 1^\circ$ 。为了使扇形的面积仍然不变，则应当把扇形的半径 $R = 20$ 厘米减少若干？

解 扇形的面积 $A = \frac{1}{2}R^2\alpha$ 。于是，

$$\Delta A \approx dA = R\alpha dR + \frac{1}{2}R^2 d\alpha.$$

按题设，应有 $\Delta A = 0$ ，即

$$20 \cdot \frac{\pi}{3} dR + \frac{1}{2} \cdot 20^2 \cdot \frac{\pi}{180} \approx 0.$$

解之，得

$$dR \approx -\frac{1}{6} \text{ (厘米)} \approx -1.7 \text{ (毫米)},$$

即应当使半径减少约 1.7 毫米。

3248. 证明乘积的相对误差近似地等于乘数的相对误差的和。

证 设 $u = xy$ ，则 $du = xdy + ydx$ ，从而

$$\frac{du}{u} = \frac{dx}{x} + \frac{dy}{y}.$$

取绝对值，得

$$\left| \frac{du}{u} \right| \leq \left| \frac{dx}{x} \right| + \left| \frac{dy}{y} \right|,$$

上式各项均表示该量的相对误差，本题获证。

3249. 当测量圆柱的底半径 R 和高 H 时所得的结果如下：

$$R = 2.5 \text{ 米} \pm 0.1 \text{ 米}; H = 4.0 \text{ 米} \pm 0.2 \text{ 米},$$

则所计算出圆柱的体积可有怎样的绝对误差 ΔV 和相对误差 δ ？

解 体积 $V = \pi R^2 H$ 。于是，

$$\Delta V \approx dV = 2\pi R dR + \pi R^2 dH.$$

以 $R = 2.5$, $H = 4.0$, $dR = 0.1$, $dH = 0.2$ 代入上式，即得

$$\Delta V \approx 10.2 \text{ 立方米},$$

$$\delta V = \left| \frac{\Delta V}{V} \right| \approx 13\%.$$

3250. 三角形的边 $a = 200 \text{ 米} \pm 2 \text{ 米}$, $b = 300 \text{ 米} \pm 5 \text{ 米}$, 它们之间的角 $C = 60^\circ \pm 1^\circ$, 则所计算出三角形的第三边 c 可有怎样的绝对误差？

解 按余弦定律，有

$$c^2 = a^2 + b^2 - 2ab \cos C,$$

微分之，即得

$$cdc = ada + bdb - b \cos C da - a \cos C db + ab \sin C dC.$$

$$\text{以 } a = 200, b = 300, c = \sqrt{200^2 + 300^2 - 2 \cdot 200 \cdot 300 \cos 60^\circ},$$

$$C = \frac{\pi}{3}, da = 2, db = 5, dC = \frac{\pi}{180} \text{ 代入上式, 即得}$$

$$dc \approx 7.6 \text{ 米},$$

故第三边 c 之绝对误差约为 7.6 米。

3251. 证明：在点 $(0, 0)$ 连续的函数

$$f(x, y) = \sqrt{|xy|}$$

于点 $(0,0)$ 有两个偏导函数 $f'_x(0,0)$ 和 $f'_y(0,0)$ ，但在点 $(0,0)$ 并非可微分的。

说明导函数 $f'_x(x,y)$ 和 $f'_y(x,y)$ 在点 $(0,0)$ 的邻域中的性质。

$$\text{解 } f'_x(0,0) = \left. \frac{d}{dx} [f(x,0)] \right|_{x=0} = 0,$$

$$f'_y(0,0) = \left. \frac{d}{dy} [f(0,y)] \right|_{y=0} = 0.$$

考察极限

$$\begin{aligned} & \lim_{\rho \rightarrow +0} \frac{f(x,y) - f(0,0) - f'_x(0,0)x - f'_y(0,0)y}{\rho} \\ &= \lim_{\rho \rightarrow +0} \frac{\sqrt{|xy|}}{\sqrt{x^2 + y^2}}, \end{aligned}$$

当动点 (x,y) 沿直线 $y=kx$ 趋于点 $(0,0)$ 时，显然对不同的 k 有不同的极限值 $\frac{\sqrt{|k|}}{\sqrt{1+k^2}}$ ，因此，上述极限不存在，即在点 $(0,0)$ ，

$$f(x,y) - f(0,0) - f'_x(0,0)x - f'_y(0,0)y$$

不能表成 $o(\rho)$ ，其中 $\rho = \sqrt{x^2 + y^2}$ ，故知 $\sqrt{|xy|}$ 在点 $(0,0)$ 不可微分。

不难得到

$$f'_x(x, y) = \begin{cases} \frac{\sqrt{|xy|}}{2x}, & x \neq 0, \\ 0, & x^2 + y^2 = 0, \\ \text{无意义}, & x = 0, y \neq 0. \end{cases}$$

因此, $f'_x(x, y)$ 在点 $(0, 0)$ 的任何邻域中均有无意义之点及无界, $f'_y(x, y)$ 的性质类似.

3252. 证明: 函数

$$f(x, y) = \frac{xy}{\sqrt{x^2 + y^2}}, \text{ 若 } x^2 + y^2 \neq 0 \text{ 及 } f(0, 0) = 0,$$

于点 $(0, 0)$ 的邻域中连续且有有界的偏导函数 $f'_x(x, y)$ 和 $f'_y(x, y)$, 但此函数于点 $(0, 0)$ 不能微分.

证 函数 $f(x, y)$ 在 $x^2 + y^2 \neq 0$ 的点显然是连续的. 由不等式

$$\begin{aligned} |f(x, y)| &= \left| \frac{xy}{\sqrt{x^2 + y^2}} \right| \leq \frac{x^2 + y^2}{2\sqrt{x^2 + y^2}} \\ &= \frac{\sqrt{x^2 + y^2}}{2} \end{aligned}$$

知 $\lim_{\substack{x \rightarrow 0 \\ y \rightarrow 0}} f(x, y) = 0 = f(0, 0)$, 故 $f(x, y)$ 在点 $(0, 0)$ 的邻域中连续.

$$f'_x(x, y) = \begin{cases} \frac{y^3}{(x^2 + y^2)^{\frac{3}{2}}}, & x^2 + y^2 \neq 0, \\ 0, & x^2 + y^2 = 0. \end{cases}$$

当 $x^2 + y^2 \neq 0$ 时, 由于

$$|f'_x(x, y)| \leq \frac{|y^3|}{(y^2)^{\frac{3}{2}}} = 1,$$

故 $f'_x(x, y)$ 在点 $(0, 0)$ 的邻域内有界. 同法可以证明 $f'_y(x, y)$ 在点 $(0, 0)$ 的邻域内有界.

由于 $f'_x(0, 0) = f'_y(0, 0) = 0$, 且极限

$$\begin{aligned} & \lim_{\rho \rightarrow +0} \frac{f(x, y) - f(0, 0) - x f'_x(0, 0) - y f'_y(0, 0)}{\rho} \\ &= \lim_{\rho \rightarrow +0} \frac{xy}{x^2 + y^2} \end{aligned}$$

是不存在的, 因此可知函数 $f(x, y)$ 在点 $(0, 0)$ 不可微分.

3253. 证明: 函数

$$f(x, y) = (x^2 + y^2) \sin \frac{1}{x^2 + y^2}, \text{ 若 } x^2 + y^2 \neq 0$$

$$\text{和 } f(0, 0) = 0$$

于点 $(0, 0)$ 的邻域中有偏导函数 $f'_x(x, y)$ 和 $f'_y(x, y)$, 这些偏导函数于点 $(0, 0)$ 是不连续的且在此点的任何邻域中是无界的; 然而此函数于点 $(0, 0)$ 可微分.

证 当 $x^2 + y^2 \neq 0$ 时, $f'_x(x, y)$ 及 $f'_y(x, y)$ 均存在, 且

$$f'_x(x, y) = 2x \sin \frac{1}{x^2 + y^2} - \frac{2x}{x^2 + y^2} \cos \frac{1}{x^2 + y^2},$$

$$f'_y(x, y) = 2y \sin \frac{1}{x^2 + y^2} - \frac{2y}{x^2 + y^2} \cos \frac{1}{x^2 + y^2},$$

又因

$$f'_x(0, 0) = \lim_{x \rightarrow 0} \frac{f(x, 0) - f(0, 0)}{x}$$

$$= \lim_{x \rightarrow 0} x \sin \frac{1}{x^2} = 0,$$

$$f'_y(0, 0) = \lim_{y \rightarrow 0} \frac{f(0, y) - f(0, 0)}{y}$$

$$= \lim_{y \rightarrow 0} y \sin \frac{1}{y^2} = 0,$$

故知在点 $(0, 0)$ 内有偏导函数 $f'_x(x, y)$ 及 $f'_y(x, y)$ 。

考虑在点 $(\frac{1}{\sqrt{2n\pi}}, 0)$ 的偏导函数 $f'_x(x, y)$ ：

$$f'_x\left(\frac{1}{\sqrt{2n\pi}}, 0\right) = \frac{2}{\sqrt{2n\pi}} \sin 2n\pi - 2\sqrt{2n\pi} \cos 2n\pi$$

$$= -2\sqrt{2n\pi} \rightarrow -\infty \quad (n \rightarrow \infty),$$

因此， $f'_x(x, y)$ 在点 $(0, 0)$ 的任何邻域内无界，由此

又知 $f'_x(x, y)$ 在点 $(0, 0)$ 不连续。同法可证 $f'_y(x, y)$

在 $(0, 0)$ 的任何邻域中也无界，从而 $f'_y(x, y)$ 在点 $(0, 0)$ 也不连续。

最后,我们证明 $f(x, y)$ 在点 $(0, 0)$ 可微分. 事实上, $f'_x(0, 0) = f'_y(0, 0) = 0$, 且

$$\begin{aligned} & \lim_{\rho \rightarrow 0} \frac{f(x, y) - f(0, 0) - x f'_x(0, 0) - y f'_y(0, 0)}{\rho} \\ &= \lim_{\rho \rightarrow 0} \sqrt{x^2 + y^2} \sin \frac{1}{\sqrt{x^2 + y^2}} = 0, \end{aligned}$$

故得

$$\begin{aligned} f(x, y) &= f(0, 0) + x f'_x(0, 0) + y f'_y(0, 0) \\ &\quad + o(\rho), \end{aligned}$$

即函数 $f(x, y)$ 在点 $(0, 0)$ 可微分.

3254. 证明: 于某凸形的域 E 内有有界偏导函数 $f'_x(x, y)$ 和 $f'_y(x, y)$ 的函数 $f(x, y)$ 于域 E 内一致连续.

证 由于 $f'_x(x, y)$ 及 $f'_y(x, y)$ 在 E 内有界, 故存在 $L > 0$, 使当 $(x, y) \in E$ 时, 恒有

$$|f'_x(x, y)| \leq \frac{L}{2},$$

及

$$|f'_y(x, y)| \leq \frac{L}{2}.$$

在 E 内取两点 $P_1(x_1, y_1)$ 及 $P_2(x_2, y_2)$.

(1) 如果以 $|P_1 P_2|$ 为直径的圆(包括圆周在内)都属于 E (图6·25), 则点 $P_3(x_1, y_2)$ 及线段

P_1P_3, P_2P_3 都在 E 内.

于是,

$$\begin{aligned} & |f(x_1, y_1) - f(x_2, \\ & y_2)| \leq |f(x_1, y_1) - \\ & f(x_1, y_2)| + |f(x_1, y_2) \\ & - f(x_2, y_2)| \end{aligned}$$

$$= |f'_y(x_1, \xi)|$$



图 6.25

$$\cdot |y_1 - y_2| + |f'_x(\eta, y_2)| \cdot |x_1 - x_2|,$$

其中 ξ 介于 y_1, y_2 之间, η 介于 x_1, x_2 之间. 由偏导函数的有界性, 即得

$$|f(x_1, y_1) - f(x_2, y_2)|$$

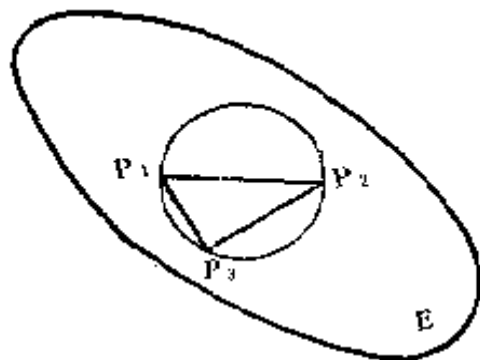
$$\leq \frac{L}{2}|y_1 - y_2| + \frac{L}{2}|x_1 - x_2|$$

$$\leq \frac{L}{2}\sqrt{(x_1 - x_2)^2 + (y_1 - y_2)^2}$$

$$+ \frac{L}{2}\sqrt{(x_1 - x_2)^2 + (y_1 - y_2)^2}$$

$$= L\sqrt{(x_1 - x_2)^2 + (y_1 - y_2)^2},$$

或

$$|f(P_1) - f(P_2)| \leq L \cdot |P_1P_2|.$$

(2) 如图 6.26 所示, $P_1 \in E, P_2 \in E$, 但点 (x_1, y_2) 和 (x_2, y_1) 都不一定属于 E . 由于 P_1 和 P_2 均为 E 的内点, 故存在 $R > 0$, 使得分别以 P_1, P_2 为

圆心， R 为半径的圆（包括圆周在内）都在 E 内。作两圆的外公切线 Q_1Q_4 及 Q_2Q_3 ，则由切点均在 E 内知，矩形 $Q_1Q_2Q_3Q_4$ 整个落在 E 内。



图 6.26

不难看出，在直线段 P_1P_2 上可取足够多的分点： $P_1=M_0, M_1, M_2, \dots, M_n=P_2$ ，使

$$|M_{k-1}M_k| < 2R \quad (k=1, 2, \dots, n),$$

则以 $|M_{k-1}M_k|$ 为直径的圆全落在矩形内，从而也在 E 内。于是，

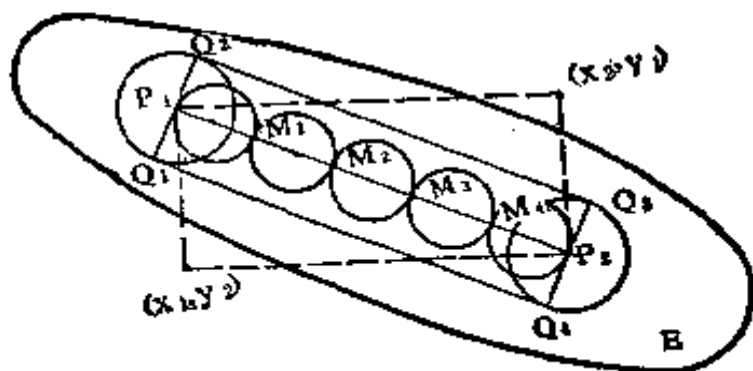
$$\begin{aligned} |f(P_1) - f(P_2)| &\leq \sum_{k=1}^n |f(M_k) - f(M_{k-1})| \\ &\leq \sum_{k=1}^n L \cdot |M_k M_{k-1}| = L \cdot \sum_{k=1}^n |M_k M_{k-1}| \\ &= L \cdot |P_1 P_2|. \end{aligned}$$

这就证明了对 E 中任意两点，函数 $f(P)$ 满足里普什兹条件。

对于任给的 $\varepsilon > 0$ ，取 $\delta = \frac{\varepsilon}{L}$ ，则当 $P_1 \in E, P_2$

$\in E$ 且 $|P_1P_2| < \delta$ 时, 就恒有

$$|f(P_1) - f(P_2)| \leq L \cdot |P_1P_2| < L\delta = \varepsilon,$$

即函数 $f(x, y)$ 在 E 中一致连续.

注. 用 ∂E 表区域 E 的边界, \bar{E} 表 E 加上 ∂E 所成的闭区域. 在本题的假定下, 还可证明 $f(x, y)$ 可开拓为 \bar{E} 上的一致连续函数. 事实上, 对 ∂E 上任一点 P_0 . 由柯西收敛准则知当点 P 从 E 内趋于 P_0 时 $f(P)$ 的极限 A 存在 (根据 $f(P)$ 在 E 的一致连续性易知它满足柯西收敛准则). 我们规定 $f(P_0) = A$. 于是 $f(P)$ 在整个 \bar{E} 上有定义. 在不等式

$$|f(P_1) - f(P_2)| \leq L \cdot |P_1P_2| \quad (P_1, P_2 \in E)$$

两端让 $P_1 \rightarrow P_0$ ($P_0 \in \partial E$) 取极限, 得

$$\begin{aligned} |f(P_0) - f(P_2)| &\leq L \cdot |P_0P_2| \\ (P_0 \in \partial E, P_2 \in E), \end{aligned}$$

再让 $P_2 \rightarrow P'_0$ ($P'_0 \in \partial E$) 取极限, 得

$$|f(P_0) - f(P'_0)| \leq L \cdot |P_0P'_0|$$

$$(P_0 \in \partial E, P'_0 \in \partial E).$$

由此可知, $f(P)$ 在 \bar{E} 上满足里普什兹条件, 从而 $f(P)$ 在 \bar{E} 上一致连续.

3255. 证明: 若函数 $f(x, y)$ 对变数 x 是连续的 (对每一个固定的值 y) 且有对变数 y 的有界的导函数 $f'_y(x, y)$, 则此函数对变数 x 和 y 的总体是连续的.

证 设 $P_0(x_0, y_0)$ 是所论的开域 E 中任一点. 取以 P_0

为中心的一个充分小的开球 G_0 ，使 G_0 完全含于 E 内。设在 G_0 内，有 $|f'_y(x, y)| \leq L$ 。于是，当 (x, y') ， (x, y'') 属于 G_0 时，有

$$\begin{aligned} |f(x, y') - f(x, y'')| &= |f'_y(x, \xi)| \cdot |y' - y''| \\ &\leq L|y' - y''|, \end{aligned}$$

其中 ξ 为介于 y' ， y'' 之间的一数，故 $f(x, y)$ 在 G_0 中满足里普什兹条件。因此，根据 3206 题结果知 $f(x, y)$ 在 G_0 中连续，特别是在 P_0 点连续。由 P_0 点的任意性，即知 $f(x, y)$ 在 E 内连续，证毕。

注。从证明过程中很明显，本题只要假定 $f'_y(x, y)$ 在 E 中每一点的某邻域中有界即可。

在下列问题中求所指出的偏导函数：

6. $\frac{\partial^4 u}{\partial x^4}$ ， $\frac{\partial^4 u}{\partial x^3 \partial y}$ ， $\frac{\partial^4 u}{\partial x^2 \partial y^2}$ ，若

$$\begin{aligned} u = &x - y + x^2 + 2xy + y^2 + x^3 - 3x^2y \\ &- y^3 + x^4 - 4x^2y^2 + y^4. \end{aligned}$$

解 $\frac{\partial^2 u}{\partial x^2} = 2 + 6x - 6y + 12x^2 - 8y^2,$

$$\frac{\partial^3 u}{\partial x^3} = 6 + 24x.$$

于是，

$$\frac{\partial^4 u}{\partial x^4} = 24, \quad \frac{\partial^4 u}{\partial x^3 \partial y} = 0, \quad \frac{\partial^4 u}{\partial x^2 \partial y^2} = -16.$$

3257. $\frac{\partial^3 u}{\partial x^2 \partial y}$, 若 $u = x \ln(xy)$.

解 $\frac{\partial u}{\partial x} = \ln(xy) + 1, \frac{\partial^2 u}{\partial x^2} = \frac{1}{x}$.

于是,

$$\frac{\partial^3 u}{\partial x^2 \partial y} = 0.$$

3258. $\frac{\partial^6 u}{\partial x^3 \partial y^3}$, 若 $u = x^3 \sin y + y^3 \sin x$.

解 $\frac{\partial^3 u}{\partial x^3} = 6 \sin y + y^3 \sin\left(x + \frac{3\pi}{2}\right)$

$$= 6 \sin y - y^3 \cos x.$$

于是,

$$\frac{\partial^6 u}{\partial x^3 \partial y^3} = 6 \sin\left(y + \frac{3\pi}{2}\right) - 6 \cos x$$

$$= -6(\cos y + \cos x).$$

3259. $\frac{\partial^3 u}{\partial x \partial y \partial z}$, 若 $u = \arctg \frac{x+y+z-xyz}{1-xy-xz-yz}$.

解 注意到

$$u = \arctg x + \arctg y + \arctg z + \varepsilon\pi \quad (\varepsilon = 0, \pm 1),$$

即得

$$\frac{\partial^3 u}{\partial x \partial y \partial z} = 0.$$

3260. $\frac{\partial^3 u}{\partial x \partial y \partial z}$, 若 $u = e^{xyz}$.

解 $\frac{\partial u}{\partial x} = yze^{xyz}, \frac{\partial^2 u}{\partial x \partial y} = ze^{xyz} + xyz^2 e^{xyz}.$

于是,

$$\begin{aligned} \frac{\partial^3 u}{\partial x \partial y \partial z} &= e^{xyz} + xyz e^{xyz} + 2xyz e^{xyz} \\ &+ x^2 y^2 z^2 e^{xyz} = e^{xyz} (1 + 3xyz + x^2 y^2 z^2). \end{aligned}$$

3261. $\frac{\partial^4 u}{\partial x \partial y \partial \xi \partial \eta},$ 若 $u = \ln \frac{1}{\sqrt{(x-\xi)^2 + (y-\eta)^2}}.$

解 设 $r = \sqrt{(x-\xi)^2 + (y-\eta)^2},$ 则 $u = -\ln r.$

$$\frac{\partial u}{\partial x} = -\frac{1}{r} \frac{\partial r}{\partial x} = -\frac{x-\xi}{r^2},$$

$$\frac{\partial^2 u}{\partial x \partial y} = \frac{2(x-\xi)(y-\eta)}{r^4},$$

$$\frac{\partial^3 u}{\partial x \partial y \partial \xi} = -\frac{2(y-\eta)}{r^4} + \frac{8(x-\xi)^2(y-\eta)}{r^6}.$$

于是,

$$\begin{aligned} \frac{\partial^4 u}{\partial x \partial y \partial \xi \partial \eta} &= \frac{2}{r^4} - \frac{8(y-\eta)^2}{r^6} \\ &- \frac{8(x-\xi)^2}{r^6} + \frac{48(x-\xi)^2(y-\eta)^2}{r^8} \\ &= -\frac{6}{r^4} + \frac{48(x-\xi)^2(y-\eta)^2}{r^8}. \end{aligned}$$

3262. $\frac{\partial^{p+q} u}{\partial x^p \partial y^q},$ 若 $u = (x-x_0)^p (y-y_0)^q.$

解 $\frac{\partial^p u}{\partial x^p} = p! \cdot (y - y_0)^q.$

于是,

$$\frac{\partial^{p+q} u}{\partial x^p \partial y^q} = p! q! \quad (p, q \text{ 均为自然数}).$$

3263. $\frac{\partial^{m+n} u}{\partial x^m \partial y^n}$, 若 $u = \frac{x+y}{x-y}.$

解 $u = 1 + \frac{2y}{x-y}, \quad \frac{\partial^m u}{\partial x^m} = (-1)^m m! \frac{2y}{(x-y)^{m+1}}.$ 利

用求高阶导数的莱布尼兹公式, 即得

$$\begin{aligned} \frac{\partial^{m+n} u}{\partial x^m \partial y^n} &= (-1)^m \cdot 2(m!) \cdot \left\{ y \frac{\partial^n}{\partial y^n} \left[\frac{1}{(x-y)^{m+1}} \right] \right. \\ &+ C_n^1 \frac{\partial}{\partial y} (y) \cdot \left. \frac{\partial^{n-1}}{\partial y^{n-1}} \left[\frac{1}{(x-y)^{m+1}} \right] \right\} \\ &= 2 \cdot (-1)^m m! \cdot \left\{ \frac{(m+1)(m+2) \cdots (m+n)y}{(x-y)^{m+n+1}} \right. \\ &+ \left. \frac{n(m+1)(m+2) \cdots (m+n-1)}{(x-y)^{m+n}} \right\} \\ &= \frac{2 \cdot (-1)^m (m+n-1)! (nx + my)}{(x-y)^{m+n-1}}. \end{aligned}$$

3264. $\frac{\partial^{m+n} u}{\partial x^m \partial y^n}$, 若 $u = (x^2 + y^2)e^{x+y}.$

解 $u = (x^2 + y^2)e^{x+y} = x^2 e^x \cdot e^y + y^2 e^y \cdot e^x = u_1 + u_2.$

显见 $\frac{\partial^m u_2}{\partial x^m} = e^x \cdot y^2 e^y$, 利用求高阶导数的莱布尼兹公

式，即得

$$\begin{aligned} \frac{\partial^{m+n}u_2}{\partial x^m \partial y^n} &= \frac{\partial^n}{\partial y^n} \left(\frac{\partial^m u_2}{\partial x^m} \right) = \frac{\partial^n}{\partial y^n} (e^x y^2 e^y) \\ &= e^x \frac{\partial^n}{\partial y^n} (y^2 e^y) = e^x \left\{ y^2 \frac{\partial^n}{\partial y^n} (e^y) \right. \\ &\quad + C_n^1 \frac{\partial}{\partial y} (y^2) \frac{\partial^{n-1}}{\partial y^{n-1}} (e^y) \\ &\quad \left. + C_n^2 \frac{\partial^2}{\partial y^2} (y^2) \frac{\partial^{n-2}}{\partial y^{n-2}} (e^y) \right\} \\ &= e^{x+y} \{ y^2 + 2ny + n(n-1) \}. \end{aligned}$$

同法可求得

$$\frac{\partial^{m+n}u_1}{\partial x^m \partial y^n} = e^{x+y} \{ x^2 + 2mx + m(m-1) \}.$$

于是，

$$\begin{aligned} \frac{\partial^{m+n}u}{\partial x^m \partial y^n} &= \frac{\partial^{m+n}u_1}{\partial x^m \partial y^n} + \frac{\partial^{m+n}u_2}{\partial x^m \partial y^n} \\ &= e^{x+y} \{ x^2 + y^2 + 2mx + 2ny + m(m-1) + n(n-1) \}. \end{aligned}$$

3265⁺. $\frac{\partial^{p+q+r}u}{\partial x^p \partial y^q \partial z^r}$, 若 $u = x y z e^{x+y+z}$.

$$\begin{aligned} \text{解} \quad \frac{\partial^{p+q+r}u}{\partial x^p \partial y^q \partial z^r} &= \frac{\partial^{p+q+r}}{\partial x^p \partial y^q \partial z^r} (x e^x \cdot y e^y \cdot z e^z) \\ &= \frac{\partial^p}{\partial x^p} (x e^x) \cdot \frac{\partial^q}{\partial y^q} (y e^y) \cdot \frac{\partial^r}{\partial z^r} (z e^z) \end{aligned}$$

$$\begin{aligned}
 &= e^x(x+p) \cdot e^y(y+q) \cdot e^z(z+r) \\
 &= e^{x+y+z}(x+p)(y+q)(z+r).
 \end{aligned}$$

3266. 若 $f(x, y) = e^x \sin y$, 求 $f_{x^m y^n}^{(m+n)}(0, 0)$.

$$\text{解 } f_{x^m y^n}^{(m+n)}(0, 0) = e^x \sin\left(y + \frac{n\pi}{2}\right) \Big|_{\substack{x=0 \\ y=0}} = \sin \frac{n\pi}{2}.$$

3267. 证明: 若

$$u = f(xyz),$$

则

$$\frac{\partial^3 u}{\partial x \partial y \partial z} = F(t),$$

式中 $t = xyz$, 并求函数 F .

$$\text{解 } \frac{\partial u}{\partial x} = yz f'(t),$$

$$\frac{\partial^2 u}{\partial x \partial y} = yz f''(t) \cdot xz + z f'(t).$$

于是,

$$\begin{aligned}
 \frac{\partial^3 u}{\partial x \partial y \partial z} &= x^2 y^2 z^2 f'''(t) + 2xyz f''(t) \\
 &\quad + f'(t) + xyz f''(t) \\
 &= x^2 y^2 z^2 f'''(t) + 3xyz f''(t) + f'(t) \\
 &= t^2 f'''(t) + 3t f''(t) + f'(t) = F(t).
 \end{aligned}$$

3268. 设 $u = x^4 - 2x^3y - 2xy^3 + y^4 + x^3 - 3x^2y - 3xy^2 + y^3 + 2x^2 - xy + 2y^2 + x + y + 1$, 求 d^4u .

导函数 $\frac{\partial^4 u}{\partial x^4}$, $\frac{\partial^4 u}{\partial x^3 \partial y}$, $\frac{\partial^4 u}{\partial x^2 \partial y^2}$, $\frac{\partial^4 u}{\partial x \partial y^3}$ 和 $\frac{\partial^4 u}{\partial y^4}$

等于甚么?

$$\text{解 } d^4 u = 24 dx^4 - 2C_1^1 d^3(x^3) dy$$

$$- 2C_1^1 dx d^3(y^3) + 24 dy^4$$

$$= 24(dx^4 - 2dx^3 dy - 2dx dy^3 + dy^4).$$

由 $d^4 u = \left(dx \frac{\partial}{\partial x} + dy \frac{\partial}{\partial y} \right)^4 u$, 得

$$\frac{\partial^4 u}{\partial x^4} = 24, \quad \frac{\partial^4 u}{\partial x^3 \partial y} = -12, \quad \frac{\partial^4 u}{\partial x^2 \partial y^2} = 0,$$

$$\frac{\partial^4 u}{\partial x \partial y^3} = -12, \quad \frac{\partial^4 u}{\partial y^4} = 24.$$

在下列各题中求所指出的阶的全微分:

3269. $d^3 u$, 若 $u = x^3 + y^3 - 3xy(x - y)$.

$$\text{解 } d^3 u = 6(dx^3 + dy^3 - 3dx^2 dy + 3dx dy^2).$$

3270. $d^3 u$, 若 $u = \sin(x^2 + y^2)$.

$$\text{解 } du = 2x \cos(x^2 + y^2) dx + 2y \cos(x^2 + y^2) dy$$

$$= 2(x dx + y dy) \cos(x^2 + y^2)$$

$$d^2 u = -4 \sin(x^2 + y^2) \cdot (x dx + y dy)^2$$

$$+ 2 \cos(x^2 + y^2) \cdot (dx^2 + dy^2).$$

于是,

$$d^3 u = -8 \cos(x^2 + y^2) \cdot (x dx + y dy)^3$$

$$\begin{aligned}
& -8\sin(x^2+y^2) \cdot (xdx+yd y) \cdot (dx^2+dy^2) \\
& -4\sin(x^2+y^2) \cdot (xdx+yd y) \cdot (dx^2+dy^2) \\
& = -8(xdx+yd y)^2 \cos(x^2+y^2) \\
& \quad -12(xdx+yd y)(dx^2+dy^2)\sin(x^2+y^2).
\end{aligned}$$

3271. $d^{10}u$, 若 $u = \ln(x+y)$.

解 $du = \frac{dx+dy}{x+y}$. 于是,

$$d^{10}u = -\frac{9!(dx+dy)^{10}}{(x+y)^{10}}.$$

3272. d^6u , 若 $u = \cos x \operatorname{ch} y$.

解 $d^6u = \left(dx \frac{\partial}{\partial x} + dy \frac{\partial}{\partial y}\right)^6 u$

$$\begin{aligned}
& = -\cos x \operatorname{ch} y dx^6 - 6\sin x \operatorname{sh} y dx^5 dy \\
& \quad + 15\cos x \operatorname{ch} y dx^4 dy^2 \\
& \quad + 20\sin x \operatorname{sh} y dx^3 dy^3 - 15\cos x \operatorname{ch} y dx^2 dy^4 \\
& \quad - 6\sin x \operatorname{sh} y dx dy^5 + \cos x \operatorname{ch} y dy^6 \\
& = -(dx^6 - 15dx^4 dy^2 + 15dx^2 dy^4 \\
& \quad - dy^6)\cos x \operatorname{ch} y - 2dx dy(3dx^4 \\
& \quad - 10dx^2 dy^2 + 3dy^4)\sin x \operatorname{sh} y.
\end{aligned}$$

3273. d^3u , 若 $u = xyz$.

解 注意到 $d^2x = d^2y = d^2z = 0$, 即得

$$\begin{aligned}
d^3u & = d^3(xyz) = C_1^3 dx d^2(yz) = 3dx \cdot (C_2^2 dy dz) \\
& = 6dx dy dz.
\end{aligned}$$

3274. d^4u , 若 $u = \ln(x^2 y^3 z^4)$.

解 由于 $u = x \ln x + y \ln y + z \ln z$, 故

$$d^4 u = (x \ln x)^{(4)} dx^4 + (y \ln y)^{(4)} dy^4 + (z \ln z)^{(4)} dz^4$$

$$= 2 \left(\frac{dx^4}{x^3} + \frac{dy^4}{y^3} + \frac{dz^4}{z^3} \right).$$

3275. $d^n u$, 若 $u = e^{ax+by}$.

解 注意到 $d^2(ax+by) = 0$, 即得

$$d^n u = d^n(e^{ax+by}) = e^{ax+by} [d(ax+by)]^n$$

$$= e^{ax+by} (adx + bdy)^n.$$

3276. $d^n u$, 若 $u = X(x)Y(y)$.

解 $d^n u = \sum_{k=0}^n C_n^k d^{n-k} X(x) \cdot d^k Y(y)$

$$= \sum_{k=0}^n C_n^k X^{(n-k)}(x) Y^{(k)}(y) dx^{n-k} dy^k,$$

3277. $d^n u$, 若 $u = f(x+y+z)$.

解 注意到 $d^2(x+y+z) = 0$, 即得

$$d^n u = f^{(n)}(x+y+z) \cdot (dx+dy+dz)^n.$$

3278. $d^n u$, 若 $u = e^{ax+by+cz}$.

解 注意到 $d^2(ax+by+cz) = 0$, 即得

$$d^n u = e^{ax+by+cz} (adx + bdy + cdz)^n.$$

3279. $P_n(x, y, z)$ 为 n 次齐次多项式. 证明

$$d^n P_n(x, y, z) = n! P_n(dx, dy, dz).$$

证 $P_n(x, y, z)$ 可表示为形如

$$Ax^p y^q z^r$$

的单项式之和, 其中 A 为常数, p, q, r 为非负整数,

且 $p+q+r=n$.

由于微分运算对加法及乘以常数是线性的（可交换的），因此要证

$$d^n P_n(x, y, z) = n! P_n(dx, dy, dz),$$

只要证明

$$d^n(x^p y^q z^r) = n! dx^p dy^q dz^r$$

就可以了.事实上,

$$\begin{aligned} d^n(x^p y^q z^r) &= C_{r, p+q}^{p+q} d^{p+q}(x^p y^q) \cdot d^r(z^r) \\ &= \frac{n!}{r!(p+q)!} \{C_{r, p+q}^{p+q} d^p(x^p) d^q(y^q) \cdot d^r(z^r)\} \\ &= \frac{n!}{r!(p+q)!} \cdot \frac{(p+q)!}{p!q!} \cdot p!q!r! dx^p dy^q dz^r \\ &= n! dx^p dy^q dz^r. \end{aligned}$$

3280. 设:

$$Au = x \frac{\partial u}{\partial x} + y \frac{\partial u}{\partial y}.$$

求 Au 和 $A^2 u = A(Au)$, 若

$$(a) u = \frac{x}{x^2 + y^2}; \quad (b) u = \ln \sqrt{x^2 + y^2}.$$

解 (a) $\frac{\partial u}{\partial x} = \frac{y^2 - x^2}{(x^2 + y^2)^2}, \quad \frac{\partial u}{\partial y} = -\frac{2xy}{(x^2 + y^2)^2}$. 于

是,

$$Au = \frac{x(y^2 - x^2)}{(x^2 + y^2)^2} - \frac{2xy^2}{(x^2 + y^2)^2} = -\frac{x}{x^2 + y^2} = -u,$$

$$A^2 u = A(Au) = A(-u) = -Au = u.$$

$$(6) \quad \frac{\partial u}{\partial x} = \frac{x}{x^2 + y^2}, \quad \frac{\partial u}{\partial y} = \frac{y}{x^2 + y^2}. \quad \text{于是,}$$

$$Au = \frac{x^2}{x^2 + y^2} + \frac{y^2}{x^2 + y^2} = 1,$$

$$A^2u = A(Au) = 0.$$

3281. 设:

$$\Delta u = \frac{\partial^2 u}{\partial x^2} + \frac{\partial^2 u}{\partial y^2}.$$

求 Δu , 若

$$(a) \quad u = \sin x \operatorname{ch} y; \quad (b) \quad u = \ln \sqrt{x^2 + y^2}.$$

解 (a) $\frac{\partial^2 u}{\partial x^2} = -\sin x \operatorname{ch} y, \quad \frac{\partial^2 u}{\partial y^2} = \sin x \operatorname{ch} y.$ 于是,

$$\Delta u = -\sin x \operatorname{ch} y + \sin x \operatorname{ch} y = 0.$$

$$(b) \quad \frac{\partial u}{\partial x} = \frac{x}{x^2 + y^2}, \quad \frac{\partial^2 u}{\partial x^2} = \frac{y^2 - x^2}{(x^2 + y^2)^2}, \quad \text{由对称}$$

性知 $\frac{\partial^2 u}{\partial y^2} = \frac{x^2 - y^2}{(x^2 + y^2)^2}.$ 于是,

$$\Delta u = \frac{y^2 - x^2}{(x^2 + y^2)^2} + \frac{x^2 - y^2}{(x^2 + y^2)^2} = 0.$$

3282. 设:

$$\Delta_1 u = \left(\frac{\partial u}{\partial x}\right)^2 + \left(\frac{\partial u}{\partial y}\right)^2 + \left(\frac{\partial u}{\partial z}\right)^2$$

及

$$\Delta_2 u = \frac{\partial^2 u}{\partial x^2} + \frac{\partial^2 u}{\partial y^2} + \frac{\partial^2 u}{\partial z^2}.$$

求 $\Delta_1 u$ 和 $\Delta_2 u$, 若

(a) $u = x^3 + y^3 + z^3 - 3xyz$;

(b) $u = \frac{1}{\sqrt{x^2 + y^2 + z^2}}$.

解 (a) $\Delta_1 u = 9[(x^2 - yz)^2 + (y^2 - zx)^2 + (z^2 - xy)^2],$
 $\Delta_2 u = 6(x + y + z).$

(b) 令 $r = \sqrt{x^2 + y^2 + z^2}$, 则 $u = \frac{1}{r}$.

$$\frac{\partial u}{\partial x} = -\frac{1}{r^2} \frac{\partial r}{\partial x} = -\frac{x}{r^3},$$

$$\frac{\partial^2 u}{\partial x^2} = -\frac{1}{r^3} + \frac{3x}{r^4} \frac{\partial r}{\partial x} = -\frac{1}{r^3} + \frac{3x^2}{r^5}.$$

由对称性即知

$$\Delta_1 u = \frac{x^2 + y^2 + z^2}{r^6} = \frac{1}{r^4} = \frac{1}{(x^2 + y^2 + z^2)^2},$$

$$\Delta_2 u = \left(-\frac{1}{r^3} + \frac{3x^2}{r^5}\right) + \left(-\frac{1}{r^3} + \frac{3y^2}{r^5}\right)$$

$$+ \left(-\frac{1}{r^3} + \frac{3z^2}{r^5}\right) = 0.$$

求下列复合函数的一阶和二阶导函数:

3283. $u = f(x^2 + y^2 + z^2).$

$$\text{解 } \frac{\partial u}{\partial x} = 2xf'(x^2 + y^2 + z^2),$$

$$\frac{\partial^2 u}{\partial x^2} = 2f'(x^2 + y^2 + z^2)$$

$$+ 4x^2 f''(x^2 + y^2 + z^2),$$

$$\frac{\partial^2 u}{\partial x \partial y} = 4xy f''(x^2 + y^2 + z^2).$$

由对称性即知

$$\frac{\partial u}{\partial y} = 2yf'(x^2 + y^2 + z^2),$$

$$\frac{\partial u}{\partial z} = 2zf'(x^2 + y^2 + z^2),$$

$$\frac{\partial^2 u}{\partial y^2} = 2f'(x^2 + y^2 + z^2)$$

$$+ 4y^2 f''(x^2 + y^2 + z^2),$$

$$\frac{\partial^2 u}{\partial z^2} = 2f'(x^2 + y^2 + z^2)$$

$$+ 4z^2 f''(x^2 + y^2 + z^2),$$

$$\frac{\partial^2 u}{\partial y \partial z} = 4yz f''(x^2 + y^2 + z^2),$$

$$\frac{\partial^2 u}{\partial z \partial x} = 4xz f''(x^2 + y^2 + z^2).$$

$$3284. \quad u = f\left(x, \frac{x}{y}\right).$$

$$\text{解 } \frac{\partial u}{\partial x} = f'_1\left(x, \frac{x}{y}\right) + \frac{1}{y}f'_2\left(x, \frac{x}{y}\right),$$

$$\frac{\partial u}{\partial y} = -\frac{x}{y^2}f'_2\left(x, \frac{x}{y}\right),$$

$$\frac{\partial^2 u}{\partial x^2} = f''_{11}\left(x, \frac{x}{y}\right) + \frac{2}{y}f''_{12}\left(x, \frac{x}{y}\right)$$

$$+ \frac{1}{y^2}f''_{22}\left(x, \frac{x}{y}\right),$$

$$\frac{\partial^2 u}{\partial y^2} = \frac{2x}{y^3}f'_2\left(x, \frac{x}{y}\right) + \frac{x^2}{y^4}f''_{22}\left(x, \frac{x}{y}\right),$$

$$\frac{\partial^2 u}{\partial x \partial y} = -\frac{x}{y^2}f''_{12}\left(x, \frac{x}{y}\right) - \frac{1}{y^2}f'_2\left(x, \frac{x}{y}\right)$$

$$- \frac{x}{y^3}f''_{22}\left(x, \frac{x}{y}\right)^*.$$

*) $f'_1, f'_2, f''_{11}, f''_{12}, f''_{22}$ 均系按其下标的次序分别对第一、第二个中间变量求导函数。以下各题均同，不再说明。

3285. $u = f(x, xy, xyz)$.

$$\text{解 } \frac{\partial u}{\partial x} = f'_1(x, xy, xyz) + yf'_2(x, xy, xyz)$$

$$+ yzf'_3(x, xy, xyz).$$

将 $f'_1(x, xy, xyz), f'_2(x, xy, xyz), f'_3(x, xy, xyz)$

简记为 f'_1, f'_2, f'_3 , 以后不再说明。于是,

$$\frac{\partial u}{\partial x} = f'_1 + yf'_2 + yzf'_3, \quad \frac{\partial u}{\partial y} = xf'_2 + xzf'_3,$$

$$\frac{\partial u}{\partial z} = xyf'_3,$$

$$\begin{aligned} \frac{\partial^2 u}{\partial x^2} &= f''_{11} + yf''_{12} + yzf''_{13} + y(f''_{21} + yf''_{22} \\ &\quad + yzf''_{23}) + yz(f''_{31} + yf''_{32} + yzf''_{33}). \end{aligned}$$

由于 $f''_{12} = f''_{21}, f''_{13} = f''_{31}, f''_{23} = f''_{32}$ (以下各题均同), 故

$$\begin{aligned} \frac{\partial^2 u}{\partial x^2} &= f''_{11} + y^2 f''_{22} + y^2 z^2 f''_{33} + 2yf''_{12} \\ &\quad + 2yzf''_{13} + 2y^2 z f''_{23}. \end{aligned}$$

同法可求得

$$\begin{aligned} \frac{\partial^2 u}{\partial y^2} &= x^2 f''_{22} + x^2 z f''_{23} + x^2 z f''_{32} + x^2 z^2 f''_{33} \\ &= x^2 f''_{22} + 2x^2 z f''_{23} + x^2 z^2 f''_{33}, \end{aligned}$$

$$\frac{\partial^2 u}{\partial z^2} = x^2 y^2 f''_{33},$$

$$\begin{aligned}
\frac{\partial^2 u}{\partial x \partial y} &= x f''_{12} + x z f''_{13} + f'_2 + x y f''_{22} + x y z f''_{23} \\
&\quad + z f'_3 + x y z f''_{32} + x y z^2 f''_{33} \\
&= x y f''_{22} + x y z^2 f''_{33} + x f''_{12} + x z f'_{13} \\
&\quad + 2 x y z f''_{23} + f'_2 + z f'_3.
\end{aligned}$$

$$\frac{\partial^2 u}{\partial x \partial z} = x y f''_{13} + x y^2 f''_{23} + x y^2 z f''_{33} + y f'_3,$$

$$\frac{\partial^2 u}{\partial y \partial z} = x^2 y f''_{23} + x^2 y z f''_{33} + x f'_3.$$

3286. 设 $u = f(x+y, xy)$, 求 $\frac{\partial^2 u}{\partial x \partial y}$.

解 $\frac{\partial u}{\partial x} = f'_1 + y f'_2$. 于是,

$$\begin{aligned}
\frac{\partial^2 u}{\partial x \partial y} &= f''_{11} + x f''_{12} + f'_2 + y f''_{21} + x y f''_{22} \\
&= f''_{11} + (x+y) f''_{12} + x y f''_{22} + f'_2.
\end{aligned}$$

3287. 设 $u = f(x+y+z, x^2+y^2+z^2)$, 求 $\Delta u = \frac{\partial^2 u}{\partial x^2} + \frac{\partial^2 u}{\partial y^2} + \frac{\partial^2 u}{\partial z^2}$.

解 $\frac{\partial u}{\partial x} = f'_1 + 2xf'_2,$

$$\frac{\partial^2 u}{\partial x^2} = f''_{11} + 2xf''_{12} + 2f'_2 + 2xf''_{21} + 4x^2 f''_{22}$$

$$= f''_{11} + 4xf''_{12} + 4x^2 f''_{22} + 2f'_2.$$

由对称性即得

$$\frac{\partial^2 u}{\partial y^2} = f''_{11} + 4yf''_{12} + 4y^2 f''_{22} + 2f'_2,$$

$$\frac{\partial^2 u}{\partial z^2} = f''_{11} + 4zf''_{12} + 4z^2 f''_{22} + 2f'_2.$$

于是,

$$\begin{aligned} \Delta u &= 3f''_{11} + 4(x+y+z)f''_{12} \\ &\quad + 4(x^2 + y^2 + z^2)f''_{22} + 6f'_2. \end{aligned}$$

求下列复合函数的一阶和二阶全微分 (x, y 及 z 为自变量):

3288. $u = f(t)$, 其中 $t = x + y$.

解 $du = f'(t)(dx + dy), d^2u = f''(t)(dx + dy)^2.$

3289. $u = f(t)$, 其中 $t = \frac{y}{x}$.

解 $du = f'(t) \cdot \frac{xdy - ydx}{x^2},$

$$d^2u = f''(t) \cdot \frac{(xdy - ydx)^2}{x^4} \\ - 2f'(t) \cdot \frac{dx(xdy - ydx)}{x^3}.$$

3290. $u = f(\sqrt{x^2 + y^2})$.

解 $du = f' \cdot \frac{xdx + ydy}{\sqrt{x^2 + y^2}},$

$$d^2u = f'' \cdot \frac{(xdx + ydy)^2}{x^2 + y^2} + f' \cdot \frac{(ydx - xdy)^2}{(x^2 + y^2)^{\frac{3}{2}}}.$$

3291. $u = f(t)$, 其中 $t = xyz$.

解 $du = f'(t)(yzdx + xzdy + xydz),$
 $d^2u = f''(t)(yzdx + xzdy + xydz)^2$
 $+ 2f'(t)(zdx dy + ydxdz + xdydz).$

3292. $u = f(x^2 + y^2 + z^2)$.

解 $du = 2f' \cdot (xdx + ydy + zdz),$
 $d^2u = 4f'' \cdot (xdx + ydy + zdz)^2$
 $+ 2f' \cdot (dx^2 + dy^2 + dz^2).$

3293. $u = f(\xi, \eta)$, 其中 $\xi = ax$, $\eta = by$.

解 $du = af'_1 dx + bf'_2 dy,$

$$d^2u = a^2 f''_{11} dx^2 + 2ab f''_{12} dx dy + b^2 f''_{22} dy^2.$$

3294. $u = f(\xi, \eta)$, 其中 $\xi = x + y$, $\eta = x - y$.

解 $du = f'_1 \cdot (dx + dy) + f'_2 \cdot (dx - dy),$

$$d^2u = f''_{11} \cdot (dx + dy)^2 + 2f''_{12} \cdot (dx^2 - dy^2) + f''_{22} \cdot (dx - dy)^2.$$

3295. $u = f(\xi, \eta)$, 其中 $\xi = xy$, $\eta = \frac{x}{y}$.

解 $du = f'_1 \cdot (ydx + xdy) + f'_2 \cdot \frac{ydx - xdy}{y^2},$

$$d^2u = f''_{11} \cdot (ydx + xdy)^2 + f''_{22} \cdot \frac{(ydx - xdy)^2}{y^4} + 2f''_{12} \cdot \frac{y^2 dx^2 - x^2 dy^2}{y^2} + 2f'_1 \cdot dx dy - 2f'_2 \cdot \frac{(ydx - xdy)dy}{y^3}.$$

3296. $u = f(x + y, z).$

解 $du = f'_1 \cdot (dx + dy) + f'_2 \cdot dz,$

$$d^2u = f''_{11} \cdot (dx + dy)^2 + 2f''_{12} \cdot (dx + dy)dz + f''_{22} dz^2.$$

3297. $u = f(x + y + z, x^2 + y^2 + z^2).$

解 $du = f'_1 \cdot (dx + dy + dz) + 2f'_2 \cdot (xdx$

$$+ ydy + zdz),$$

$$\begin{aligned} d^2u &= f''_{11} \cdot (dx + dy + dz)^2 + 4f''_{12} \cdot (dx \\ &+ dy + dz)(xdx + ydy + zdz) \\ &+ 4f''_{22} \cdot (xdx + ydy + zdz)^2 + 2f'_2 \cdot (dx^2 \\ &+ dy^2 + dz^2). \end{aligned}$$

3298. $u = f\left(\frac{x}{y}, \frac{y}{z}\right).$

解 $du = f'_1 \cdot \frac{ydx - xdy}{y^2} + f'_2 \cdot \frac{zdy - ydz}{z^2},$

$$d^2u = f''_{11} \cdot \frac{(ydx - xdy)^2}{y^4} + f''_{22} \cdot \frac{(zdy - ydz)^2}{z^4}$$

$$+ 2f''_{12} \cdot \frac{(ydx - xdy)(zdy - ydz)}{y^2 z^2}$$

$$- 2f'_1 \cdot \frac{(ydx - xdy)dy}{y^3} - 2f'_2 \cdot \frac{(zdy - ydz)dz}{z^3}.$$

3299. $u = f(x, y, z)$, 其中 $x = t, y = t^2, z = t^3.$

解 $du = (f'_1 + 2tf'_2 + 3t^2f'_3)dt,$

$$d^2u = (f''_{11} + 4t^2f''_{22} + 9t^4f''_{33} + 4tf''_{12} + 6t^2f''_{13}$$

$$+ 12t^3f''_{23} + 2f'_2 + 6tf'_3)dt^2.$$

3300. $u = f(\xi, \eta, \zeta)$, 其中 $\xi = ax, \eta = by, \zeta = cz.$

解 $du = af'_1 \cdot dx + bf'_2 \cdot dy + cf'_3 \cdot dz,$

$$d^2u = a^2 f''_{11} \cdot dx^2 + b^2 f''_{22} \cdot dy^2 + c^2 f''_{33} \cdot dz^2$$

$$+ 2abf''_{12} \cdot dx dy + 2acf''_{13} \cdot dx dz + 2bcf''_{23} \cdot dy dz.$$

3301. $u = f(\xi, \eta, \zeta)$, 其中 $\xi = x^2 + y^2$, $\eta = x^2 - y^2$,
 $\zeta = 2xy$.

解 $du = 2f'_1 \cdot (xdx + ydy) + 2f'_2 \cdot (xdx - ydy)$

$$+ 2f'_3 \cdot (ydx + xdy),$$

$$d^2u = 4f''_{11} \cdot (xdx + ydy)^2 + 4f''_{22} \cdot (xdx - ydy)^2$$

$$+ 4f''_{33} \cdot (ydx + xdy)^2 + 8f''_{12} \cdot (x^2 dx^2 - y^2 dy^2)$$

$$+ 8f''_{13} \cdot (xdx + ydy)(ydx + xdy)$$

$$+ 8f''_{23} \cdot (xdx - ydy)(ydx + xdy) + 2f'_1 \cdot (dx^2$$

$$+ dy^2) + 2f'_2 \cdot (dx^2 - dy^2) + 4f'_3 \cdot dx dy.$$

求 $d^n u$, 设:

3302. $u = f(ax + by + cz).$

解 $d^n u = f^{(n)}(ax + by + cz) \cdot (adx + bdy + cdz)^n.$

3303. $u = f(ax, by, cz).$

解 $d'u = \left(a dx \frac{\partial}{\partial \xi} + b dy \frac{\partial}{\partial \eta} + c dz \frac{\partial}{\partial \zeta} \right)' f(\xi, \eta, \zeta),$

其中 $\xi = ax, \eta = by, \zeta = cz.$

3304. $u = f(\xi, \eta, \zeta),$ 其中 $\xi = a_1x + b_1y + c_1z,$
 $\eta = a_2x + b_2y + c_2z, \zeta = a_3x + b_3y + c_3z.$

解 $d'u = \left[(a_1 dx + b_1 dy + c_1 dz) \frac{\partial}{\partial \xi} + (a_2 dx + b_2 dy + c_2 dz) \frac{\partial}{\partial \eta} + (a_3 dx + b_3 dy + c_3 dz) \frac{\partial}{\partial \zeta} \right]' f(\xi, \eta, \zeta)$
 $= \left[dx \left(a_1 \frac{\partial}{\partial \xi} + a_2 \frac{\partial}{\partial \eta} + a_3 \frac{\partial}{\partial \zeta} \right) + dy \left(b_1 \frac{\partial}{\partial \xi} + b_2 \frac{\partial}{\partial \eta} + b_3 \frac{\partial}{\partial \zeta} \right) + dz \left(c_1 \frac{\partial}{\partial \xi} + c_2 \frac{\partial}{\partial \eta} + c_3 \frac{\partial}{\partial \zeta} \right) \right]' f(\xi, \eta, \zeta).$

3305. 设 $u = f(r),$ 其中 $r = \sqrt{x^2 + y^2 + z^2}$ 和 f 为可微分两次的函数. 证明:

$$\Delta u = F(r),$$

其中 $\Delta u = \frac{\partial^2 u}{\partial x^2} + \frac{\partial^2 u}{\partial y^2} + \frac{\partial^2 u}{\partial z^2},$ Δ 为拉普拉斯算子,

并求函数 $F.$

解 $\frac{\partial u}{\partial x} = f'(r) \cdot \frac{x}{r},$

$$\frac{\partial^2 u}{\partial x^2} = f''(r) \cdot \frac{x^2}{r^2} + f'(r) \cdot \frac{r^2 - x^2}{r^3}.$$

由对称性即得

$$\frac{\partial^2 u}{\partial y^2} = f''(r) \cdot \frac{y^2}{r^2} + f'(r) \cdot \frac{r^2 - y^2}{r^3},$$

$$\frac{\partial^2 u}{\partial z^2} = f''(r) \cdot \frac{z^2}{r^2} + f'(r) \cdot \frac{r^2 - z^2}{r^3}.$$

于是,

$$\begin{aligned} \Delta u &= \frac{\partial^2 u}{\partial x^2} + \frac{\partial^2 u}{\partial y^2} + \frac{\partial^2 u}{\partial z^2} = f''(r) \\ &\quad + 2f'(r) \cdot \frac{1}{r} = F(r). \end{aligned}$$

3306. 设 u 和 v 为可微分两次的函数而 Δ 为拉普拉斯算子 (参阅 3305 题). 证明:

$$\Delta(uv) = u\Delta v + v\Delta u + 2\Delta(u, v),$$

$$\text{其中 } \Delta(u, v) = \frac{\partial u}{\partial x} \frac{\partial v}{\partial x} + \frac{\partial u}{\partial y} \frac{\partial v}{\partial y} + \frac{\partial u}{\partial z} \frac{\partial v}{\partial z}.$$

$$\begin{aligned} \text{证 } \Delta(uv) &= \frac{\partial^2(uv)}{\partial x^2} + \frac{\partial^2(uv)}{\partial y^2} + \frac{\partial^2(uv)}{\partial z^2} \\ &= \left(u \frac{\partial^2 v}{\partial x^2} + v \frac{\partial^2 u}{\partial x^2} + 2 \frac{\partial u}{\partial x} \frac{\partial v}{\partial x} \right) \\ &\quad + \left(u \frac{\partial^2 v}{\partial y^2} + v \frac{\partial^2 u}{\partial y^2} + 2 \frac{\partial u}{\partial y} \frac{\partial v}{\partial y} \right) \end{aligned}$$

$$+ \left(u \frac{\partial^2 v}{\partial z^2} + v \frac{\partial^2 u}{\partial z^2} + 2 \frac{\partial u}{\partial z} \frac{\partial v}{\partial z} \right)$$

$$= u \Delta v + v \Delta u + 2 \Delta(u, v),$$

这就是所要证明的。

3307. 证明：函数

$$u = \ln \sqrt{(x-a)^2 + (y-b)^2}$$

(a 和 b 为常数) 满足拉普拉斯方程

$$\frac{\partial^2 u}{\partial x^2} + \frac{\partial^2 u}{\partial y^2} = 0.$$

证
$$\frac{\partial u}{\partial x} = \frac{x-a}{(x-a)^2 + (y-b)^2},$$

$$\frac{\partial^2 u}{\partial x^2} = \frac{(y-b)^2 - (x-a)^2}{[(x-a)^2 + (y-b)^2]^2}.$$

由对称性即得

$$\frac{\partial^2 u}{\partial y^2} = \frac{(x-a)^2 - (y-b)^2}{[(x-a)^2 + (y-b)^2]^2}.$$

于是,

$$\frac{\partial^2 u}{\partial x^2} + \frac{\partial^2 u}{\partial y^2} = 0.$$

3308. 证明：若函数 $u = u(x, y)$ 满足拉普拉斯方程 (参阅 3307 题), 则函数

$$v = u\left(\frac{x}{x^2 + y^2}, \frac{y}{x^2 + y^2}\right)$$

也满足这方程。

证 设 $\xi = \frac{x}{x^2 + y^2}$, $\eta = \frac{y}{x^2 + y^2}$, 则 $v(x, y)$
 $= u(\xi, \eta)$. 从而

$$v''_{xx} = u''_{\xi\xi} \cdot (\xi'_x)^2 + u''_{\eta\eta} \cdot (\eta'_x)^2 + 2u''_{\xi\eta} \cdot \xi'_x \eta'_x \\
+ u'_\xi \cdot \xi''_{xx} + u'_\eta \cdot \eta''_{xx},$$

$$v''_{yy} = u''_{\xi\xi} \cdot (\xi'_y)^2 + u''_{\eta\eta} \cdot (\eta'_y)^2 + 2u''_{\xi\eta} \cdot \xi'_y \eta'_y \\
+ u'_\xi \cdot \xi''_{yy} + u'_\eta \cdot \eta''_{yy}.$$

由于

$$\xi'_x = \frac{y^2 - x^2}{(x^2 + y^2)^2} = -\eta'_y, \xi'_y = -\frac{2xy}{(x^2 + y^2)^2} = \eta'_x,$$

$$\xi''_{yy} = (\xi'_y)'_y = (\eta'_x)'_y = (\eta'_y)'_x = -\xi''_{xx},$$

$$\eta''_{yy} = (\eta'_y)'_y = (-\xi'_x)'_y = -(\xi'_y)'_x = -\eta''_{xx}$$

及

$$u''_{\xi\xi}(\xi, \eta) + u''_{\eta\eta}(\xi, \eta) = 0,$$

故

$$\Delta v = v''_{xx} + v''_{yy} = u''_{\xi\xi} \cdot (\xi'_x)^2 + u''_{\eta\eta} \cdot (\eta'_x)^2$$

$$\begin{aligned}
& + 2u'_{\xi\eta} \cdot \xi'_x \eta'_x + u'_z \cdot \xi''_{xx} \\
& + u'_\eta \cdot \eta''_{xx} + u'_{\xi\xi} \cdot (\eta'_x)^2 + u'_{\eta\eta} \cdot (-\xi'_x)^2 \\
& + 2u'_{\xi\eta} \cdot \eta'_x (-\xi'_x) + u'_z \cdot (-\xi''_{xx}) + u'_\eta \cdot (-\eta''_{xx}) \\
& = (u'_{\xi\xi} + u'_{\eta\eta}) \left[(\xi'_x)^2 + (\eta'_x)^2 \right] = 0,
\end{aligned}$$

即函数 v 也满足拉普拉斯方程。

3309. 证明: 函数

$$u = \frac{1}{2a\sqrt{\pi t}} e^{-\frac{(x-b)^2}{4a^2 t}}$$

(a 和 b 为常数) 满足热传导方程

$$\frac{\partial u}{\partial t} = a^2 \frac{\partial^2 u}{\partial x^2}.$$

证 $\frac{\partial u}{\partial t} = \frac{1}{8a^3 t^2 \sqrt{\pi t}} e^{-\frac{(x-b)^2}{4a^2 t}} \cdot \left[(x-b)^2 - 2a^2 t \right],$

$$\frac{\partial u}{\partial x} = -\frac{x-b}{4a^3 t \sqrt{\pi t}} e^{-\frac{(x-b)^2}{4a^2 t}},$$

$$\frac{\partial^2 u}{\partial x^2} = \frac{1}{8a^5 t^2 \sqrt{\pi t}} e^{-\frac{(x-b)^2}{4a^2 t}} \cdot \left[(x-b)^2 - 2a^2 t \right].$$

将 $\frac{\partial u}{\partial t}$ 与 $\frac{\partial^2 u}{\partial x^2}$ 比较即得

$$\frac{\partial u}{\partial t} = a^2 \frac{\partial^2 u}{\partial x^2},$$

即函数 u 满足热传导方程。

3310. 证明: 若函数 $u = u(x, t)$ 满足热传导方程 (参阅 3309 题), 则函数

$$v = \frac{1}{a\sqrt{t}} e^{-\frac{x^2}{4a^2t}} u\left(\frac{x}{a^2t}, -\frac{1}{a^4t}\right) \quad (t > 0)$$

也满足该方程。

证 设 $w = w(x, t) = \frac{1}{a\sqrt{t}} e^{-\frac{x^2}{4a^2t}}$, 此函数即 3309 题

中的函数 u 乘以 $2\sqrt{\pi}$, 并令 $b = 0$ 后得到。因此, 它满足热传导方程

$$\frac{\partial w}{\partial t} = a^2 \frac{\partial^2 w}{\partial x^2}.$$

显然有

$$\frac{\partial w}{\partial x} = -\frac{2x}{4a^2t} w = -\frac{xw}{2a^2t}.$$

令 $\xi = \xi(x, t) = \frac{x}{a^2t}$, $\eta = \eta(t) = -\frac{1}{a^4t}$, 则

$$\xi'_x = \frac{1}{a^2t}, \xi''_{xx} = 0, \xi'_t = -\frac{x^2}{a^2t^2}, \eta'_t = \frac{1}{a^4t^2}.$$

由于 $v = w(x, t) \cdot u(\xi, \eta)$ 及 $v'_x = a^2 u''_{\xi\xi}$, 故

$$v_t^1 = w_t^1 \cdot u + w \cdot (u_\xi^1 \cdot \xi_t^1 + u_\eta^1 \cdot \eta_t^1)$$

$$= a^2 w_{xx}^1 \cdot u + w \cdot \left[u_\xi^1 \cdot \left(-\frac{x^2}{a^2 t^2} \right) + a^2 u_{\xi\xi}^1 \cdot \left(\frac{1}{a^4 t^2} \right) \right],$$

$$v_x^1 = w_x^1 \cdot u + w u_\xi^1 \cdot \xi_x^1,$$

$$v_{xx}^1 = w_{xx}^1 \cdot u + 2w_x^1 \cdot u_\xi^1 \xi_x^1 + w u_{\xi\xi}^1 \cdot (\xi_x^1)^2 + w u_\xi^1 \cdot \xi_{xx}^1$$

$$= w_{xx}^1 \cdot u + 2 \left(-\frac{xw}{2a^2 t} \right) u_\xi^1 \cdot \left(\frac{x}{a^2 t} \right) + w u_{\xi\xi}^1 \cdot \left(\frac{1}{a^2 t} \right)^2$$

$$= w_{xx}^1 \cdot u - \frac{x^2 w}{a^4 t^2} u_\xi^1 + \frac{w}{a^4 t^2} u_{\xi\xi}^1.$$

将 v_t^1 与 v_{xx}^1 比较即得

$$v_t^1 = a^2 v_{xx}^1,$$

即函数 v 也满足热传导方程。

3311. 证明: 函数

$$u = \frac{1}{r}$$

(式中 $r = \sqrt{(x-a)^2 + (y-b)^2 + (z-c)^2}$) 当 $r \neq 0$ 时, 满足拉普拉斯方程

$$\Delta u = \frac{\partial^2 u}{\partial x^2} + \frac{\partial^2 u}{\partial y^2} + \frac{\partial^2 u}{\partial z^2} = 0.$$

证 本题证法与 3282 题(6)的证法完全类似, 只要将该题中的 x, y, z 换成 $x-a, y-b, z-b$ 即可. 事实上,

$$\frac{\partial^2 u}{\partial x^2} = -\frac{1}{r^3} + \frac{3(x-a)^2}{r^5},$$

$$\frac{\partial^2 u}{\partial y^2} = -\frac{1}{r^3} + \frac{3(y-b)^2}{r^5},$$

$$\frac{\partial^2 u}{\partial z^2} = -\frac{1}{r^3} + \frac{3(z-c)^2}{r^5}.$$

将上述三式相加, 即证得

$$\Delta\left(\frac{1}{r}\right) = 0.$$

3312. 证明: 若函数 $u = u(x, y, z)$ 满足拉普拉斯方程 (参阅 3311 题), 则函数

$$v = \frac{1}{r} u\left(\frac{k^2 x}{r^2}, \frac{k^2 y}{r^2}, \frac{k^2 z}{r^2}\right)$$

(式中 k 为常数及 $r = \sqrt{x^2 + y^2 + z^2}$) 也满足该方程.

证 证法一

设 $S = S(x, y, z) = \frac{1}{r}$, 则由 3282 题(6)知

$$\Delta S = S''_{xx} + S''_{yy} + S''_{zz} = 0,$$

$$(S'_x)^2 + (S'_y)^2 + (S'_z)^2 = \frac{1}{r^4} = S^4.$$

$$S'_x = -\frac{x}{r^3} = -S^3 x, \quad S'_y = -S^3 y, \quad S'_z = -S^3 z.$$

$$\begin{aligned} \text{记 } v &= \frac{1}{r} u \left(\frac{k^2 x}{r^2}, \frac{k^2 y}{r^2}, \frac{k^2 z}{r^2} \right) \\ &= Su(k^2 S^2 x, k^2 S^2 y, k^2 S^2 z) \\ &= Sw(x, y, z, S) = F(x, y, z, S). \end{aligned}$$

于是,

$$v'_x = F'_x + F'_S \cdot S'_x.$$

注意到 F'_x 和 F'_S 也是自变量 x, y, z 和中间变量 S 的函数, 即得

$$v''_{xx} = F''_{xx} + 2F''_{xS} \cdot S'_x + F''_{SS} \cdot (S'_x)^2 + F'_S \cdot S''_{xx}.$$

由对称性得

$$v''_{yy} = F''_{yy} + 2F''_{yS} \cdot S'_y + F''_{SS} \cdot (S'_y)^2 + F'_S \cdot S''_{yy},$$

$$v''_{zz} = F''_{zz} + 2F''_{zS} \cdot S'_z + F''_{SS} \cdot (S'_z)^2 + F'_S \cdot S''_{zz}.$$

于是,

$$\Delta v = (F''_{xx} + F''_{yy} + F''_{zz}) + F'_S \cdot (S''_{xx} + S''_{yy} + S''_{zz})$$

$$+ \left\{ 2(F''_{xs} \cdot S'_x + F''_{ys} \cdot S'_y + F''_{zs} \cdot S'_z) \right. \\ \left. + F''_{ss} \cdot \left[(S'_x)^2 + (S'_y)^2 + (S'_z)^2 \right] \right\}.$$

显然第二个括弧为零，也不难验证第一个括弧为零。事实上，

$$F''_{xx} + F''_{yy} + F''_{zz} = k^4 S^6 \cdot (u''_{11} + u''_{22} + u''_{33}) = 0.$$

现在来计算最后一个括弧。注意到

$$S w'_s = 2k^2 S^2 x u'_1 + 2k^2 S^2 y u'_2 + 2k^2 S^2 z u'_3 \\ = 2x w'_x + 2y w'_y + 2z w'_z,$$

即得

$$F''_{ss} \cdot \left[(S'_x)^2 + (S'_y)^2 + (S'_z)^2 \right] = (S w)''_{ss} \cdot S^4 \\ = (w + S w'_s)'_s \cdot S^4 \\ = (w + 2x w'_x + 2y w'_y + 2z w'_z)'_s \cdot S^4 \\ = S^4 w'_s + 2x S^4 w''_{xs} + 2y S^4 w''_{ys} + 2z S^4 w''_{zs}. \quad (1)$$

而

$$2(F''_{xs} \cdot S'_x + F''_{ys} \cdot S'_y + F''_{zs} \cdot S'_z)$$

$$\begin{aligned}
&= 2(Sw)''_{xs} \cdot (-S^3x) + 2(Sw)''_{ys} \cdot (-S^3y) \\
&\quad + 2(Sw)''_{zs} \cdot (-S^3z) \\
&= -2S^3x \cdot (Sw'_x)'_s - 2S^3y \cdot (Sw'_y)'_s - 2S^3z \cdot (Sw'_z)'_s \\
&= -2S^3x \cdot (w'_x + Sw''_{xs}) - 2S^3y \cdot (w'_y \\
&\quad + Sw''_{ys}) - 2S^3z \cdot (w'_z + Sw''_{zs}) \\
&= -S^3 \cdot (2xw'_x + 2yw'_y + 2zw'_z) - 2S^4w''_{xs} \\
&\quad - 2yS^4w''_{ys} - 2zS^4w''_{zs} \\
&= -S^4w'_s - 2xS^4w''_{xs} - 2yS^4w''_{ys} - 2zS^4w''_{zs}. \quad (2)
\end{aligned}$$

比较(1)式和(2)式即知第三个括弧也为零。于是，最后证得

$$\Delta v = 0$$

证法二

本题也可直接求出 $\frac{\partial^2 u}{\partial x^2}$ 、 $\frac{\partial^2 u}{\partial y^2}$ 、 $\frac{\partial^2 u}{\partial z^2}$ ，进而证得

$\Delta v = 0$ 。事实上，设

$$\frac{k^2 x}{r^2} = t_1, \quad \frac{k^2 y}{r^2} = t_2, \quad \frac{k^2 z}{r^2} = t_3,$$

利用 3306 题的结果即得

$$\begin{aligned} \Delta v = & \frac{1}{r} \left[\frac{\partial^2 u(t_1, t_2, t_3)}{\partial x^2} + \frac{\partial^2 u(t_1, t_2, t_3)}{\partial y^2} \right. \\ & \left. + \frac{\partial^2 u(t_1, t_2, t_3)}{\partial z^2} \right] + u(t_1, t_2, t_3) \Delta \left(\frac{1}{r} \right) \\ & + 2 \left[\frac{\partial u(t_1, t_2, t_3)}{\partial x} \frac{\partial \left(\frac{1}{r} \right)}{\partial x} + \frac{\partial u(t_1, t_2, t_3)}{\partial y} \right. \\ & \left. \cdot \frac{\partial \left(\frac{1}{r} \right)}{\partial y} + \frac{\partial u(t_1, t_2, t_3)}{\partial z} \frac{\partial \left(\frac{1}{r} \right)}{\partial z} \right]. \quad (1) \end{aligned}$$

为书写简便起见, 记 $u(t_1, t_2, t_3) = u$. 分别求 u 及 $\frac{1}{r}$ 对 x, y, z 的一阶偏导函数:

$$\begin{aligned} \frac{\partial u}{\partial x} = & k^2 \cdot \left[\frac{\partial u}{\partial t_1} \cdot \left(\frac{r^2 - 2x^2}{r^4} \right) + \frac{\partial u}{\partial t_2} \right. \\ & \left. \cdot \left(-\frac{2xy}{r^4} \right) + \frac{\partial u}{\partial t_3} \cdot \left(-\frac{2xz}{r^4} \right) \right], \end{aligned}$$

$$\begin{aligned} \frac{\partial u}{\partial y} = & k^2 \cdot \left[\frac{\partial u}{\partial t_1} \cdot \left(-\frac{2xy}{r^4} \right) + \frac{\partial u}{\partial t_2} \right. \\ & \left. \cdot \left(\frac{r^2 - 2y^2}{r^4} \right) + \frac{\partial u}{\partial t_3} \cdot \left(-\frac{2yz}{r^4} \right) \right], \end{aligned}$$

$$\begin{aligned} \frac{\partial u}{\partial z} = & k^2 \cdot \left[\frac{\partial u}{\partial t_1} \cdot \left(-\frac{2xz}{r^4} \right) + \frac{\partial u}{\partial t_2} \right. \\ & \left. \cdot \left(-\frac{2yz}{r^4} \right) + \frac{\partial u}{\partial t_3} \cdot \left(\frac{r^2 - 2z^2}{r^4} \right) \right]; \end{aligned}$$

$$\frac{\partial(\frac{1}{r})}{\partial x} = -\frac{x}{r^3}, \quad \frac{\partial(\frac{1}{r})}{\partial y} = -\frac{y}{r^3},$$

$$\frac{\partial(\frac{1}{r})}{\partial z} = -\frac{z}{r^3}.$$

从而得

$$\begin{aligned} \frac{\partial^2 u}{\partial x^2} &= k^4 \cdot \left[\frac{\partial^2 u}{\partial t_1^2} \cdot \left(\frac{r^2 - 2x^2}{r^4} \right) + \frac{\partial^2 u}{\partial t_1 \partial t_2} \right. \\ &\quad \cdot \left(-\frac{2xy}{r^4} \right) + \left. \frac{\partial^2 u}{\partial t_1 \partial t_3} \cdot \left(-\frac{2xz}{r^4} \right) \right] \left(\frac{r^2 - 2x^2}{r^4} \right) \\ &\quad + k^2 \frac{\partial u}{\partial t_1} \cdot \left[\frac{-2xr^4 - 4xr^2(r^2 - 2x^2)}{r^8} \right] \\ &\quad + k^4 \cdot \left[\frac{\partial^2 u}{\partial t_2 \partial t_1} \cdot \left(\frac{r^2 - 2x^2}{r^4} \right) + \frac{\partial^2 u}{\partial t_2^2} \cdot \left(-\frac{2xy}{r^4} \right) \right. \\ &\quad \left. + \frac{\partial^2 u}{\partial t_2 \partial t_3} \cdot \left(-\frac{2xz}{r^4} \right) \right] \left(-\frac{2xy}{r^4} \right) \\ &\quad + k^2 \frac{\partial u}{\partial t_2} \cdot \left[\frac{-2yr^4 - 4xr^2(-2xy)}{r^8} \right] \\ &\quad + k^4 \cdot \left[\frac{\partial^2 u}{\partial t_3 \partial t_1} \cdot \left(\frac{r^2 - 2x^2}{r^4} \right) + \frac{\partial^2 u}{\partial t_3 \partial t_2} \cdot \left(-\frac{2xy}{r^4} \right) \right. \\ &\quad \left. + \frac{\partial^2 u}{\partial t_3^2} \cdot \left(-\frac{2xz}{r^4} \right) \right] \left(-\frac{2xz}{r^4} \right) \\ &\quad + k^2 \frac{\partial u}{\partial t_3} \cdot \left[\frac{-2zr^4 - 4xr^2(-2xz)}{r^8} \right], \end{aligned}$$

$$\begin{aligned}
\frac{\partial^2 u}{\partial y^2} &= k^4 \cdot \left[\frac{\partial^2 u}{\partial t_1^2} \cdot \left(-\frac{2xy}{r^4} \right) + \frac{\partial^2 u}{\partial t_1 \partial t_2} \right. \\
&\quad \cdot \left(\frac{r^2 - 2y^2}{r^4} \right) + \left. \frac{\partial^2 u}{\partial t_1 \partial t_3} \cdot \left(-\frac{2yz}{r^4} \right) \right] \left(-\frac{2xy}{r^4} \right) \\
&+ k^2 \frac{\partial u}{\partial t_1} \cdot \left[\frac{-2xr^4 - 4yr^2(-2xy)}{r^8} \right] \\
&+ k^4 \cdot \left[\frac{\partial^2 u}{\partial t_2 \partial t_1} \cdot \left(-\frac{2xy}{r^4} \right) + \frac{\partial^2 u}{\partial t_2^2} \cdot \left(\frac{r^2 - 2y^2}{r^4} \right) \right. \\
&\quad \left. + \frac{\partial^2 u}{\partial t_2 \partial t_3} \cdot \left(-\frac{2yz}{r^4} \right) \right] \left(\frac{r^2 - 2y^2}{r^4} \right) \\
&+ k^2 \frac{\partial u}{\partial t_2} \cdot \left[\frac{-2yr^4 - 4yr^2(r^2 - 2y^2)}{r^8} \right] \\
&+ k^4 \cdot \left[\frac{\partial^2 u}{\partial t_3 \partial t_1} \cdot \left(-\frac{2xy}{r^4} \right) + \frac{\partial^2 u}{\partial t_3 \partial t_2} \right. \\
&\quad \left. \cdot \left(\frac{r^2 - 2y^2}{r^4} \right) + \frac{\partial^2 u}{\partial t_3^2} \cdot \left(-\frac{2yz}{r^4} \right) \right] \left(-\frac{2yz}{r^4} \right) \\
&+ k^2 \frac{\partial u}{\partial t_3} \cdot \left[\frac{-2zr^4 - 4yr^2(-2yz)}{r^8} \right],
\end{aligned}$$

$$\begin{aligned}
\frac{\partial^2 u}{\partial z^2} &= k^4 \cdot \left[\frac{\partial^2 u}{\partial t_1^2} \cdot \left(-\frac{2xz}{r^4} \right) + \frac{\partial^2 u}{\partial t_1 \partial t_2} \right. \\
&\quad \left. \cdot \left(-\frac{2yz}{r^4} \right) + \frac{\partial^2 u}{\partial t_1 \partial t_3} \cdot \left(\frac{r^2 - 2z^2}{r^4} \right) \right] \left(-\frac{2xz}{r^4} \right) \\
&+ k^2 \frac{\partial u}{\partial t_1} \cdot \left[\frac{-2xr^4 - 4zr^2(-2xz)}{r^8} \right]
\end{aligned}$$

$$\begin{aligned}
& + k^4 \cdot \left[\frac{\partial^2 u}{\partial t_2 \partial t_1} \cdot \left(-\frac{2xz}{r^4} \right) + \frac{\partial^2 u}{\partial t_2^2} \cdot \left(-\frac{2yz}{r^4} \right) \right. \\
& + \left. \frac{\partial^2 u}{\partial t_2 \partial t_3} \cdot \left(\frac{r^2 - 2z^2}{r^4} \right) \right] \left(-\frac{2yz}{r^4} \right) \\
& + k^2 \frac{\partial u}{\partial t_z} \cdot \left[\frac{-2yr^4 - 4zr^2(-2yz)}{r^8} \right] \\
& + k^4 \cdot \left[\frac{\partial^2 u}{\partial t_3 \partial t_1} \cdot \left(-\frac{2xz}{r^4} \right) + \frac{\partial^2 u}{\partial t_3 \partial t_2} \cdot \left(-\frac{2yz}{r^4} \right) \right. \\
& + \left. \frac{\partial^2 u}{\partial t_3^2} \cdot \left(\frac{r^2 - 2z^2}{r^4} \right) \right] \left(\frac{r^2 - 2z^2}{r^4} \right) \\
& + k^2 \frac{\partial u}{\partial t_s} \cdot \left[\frac{-2zr^4 - 4zr^2(r^2 - 2z^2)}{r^8} \right].
\end{aligned}$$

$$\text{將 } \frac{\partial u}{\partial x}, \frac{\partial u}{\partial y}, \frac{\partial u}{\partial z}, \frac{\partial\left(\frac{1}{r}\right)}{\partial x}, \frac{\partial\left(\frac{1}{r}\right)}{\partial y}, \frac{\partial\left(\frac{1}{r}\right)}{\partial z},$$

及 $\frac{\partial^2 u}{\partial x^2}, \frac{\partial^2 u}{\partial y^2}, \frac{\partial^2 u}{\partial z^2}$ 代入 (1) 式, 合并整理, 并注意

$$\Delta\left(\frac{1}{r}\right) = 0 \text{ 及 } \frac{\partial^2 u}{\partial t_1^2} + \frac{\partial^2 u}{\partial t_2^2} + \frac{\partial^2 u}{\partial t_3^2} = 0,$$

即得

$$\begin{aligned}
\Delta v &= \frac{1}{r} \left[\frac{k^4}{r^4} \cdot \left(\frac{\partial^2 u}{\partial t_1^2} + \frac{\partial^2 u}{\partial t_2^2} + \frac{\partial^2 u}{\partial t_3^2} \right) \right. \\
& - \left. \frac{2k^2}{r^4} \cdot \left(x \frac{\partial u}{\partial t_1} + y \frac{\partial u}{\partial t_2} + z \frac{\partial u}{\partial t_3} \right) \right]
\end{aligned}$$

$$+ 0 \cdot \sum_{\substack{i=1 \\ (i+1)}}^3 \frac{\partial^2 u}{\partial t_i \partial t_i} \Big] + u \cdot 0 + \frac{2k^2}{r^5} \left(x \frac{\partial u}{\partial t_1} \right. \\ \left. + y \frac{\partial u}{\partial t_2} + z \frac{\partial u}{\partial t_3} \right) = 0,$$

上式说明函数 $v = v(x, y, z)$ 也满足拉普拉斯方程。

3313. 证明：函数

$$u = \frac{C_1 e^{-ar} + C_2 e^{ar}}{r}$$

(式中 $r = \sqrt{x^2 + y^2 + z^2}$ 及 C_1, C_2 为常数) 满足
爱尔木戈尔兹方程

$$\frac{\partial^2 u}{\partial x^2} + \frac{\partial^2 u}{\partial y^2} + \frac{\partial^2 u}{\partial z^2} = a^2 u.$$

证 设

$$v = \frac{1}{r} e^{-ar}, \quad w = \frac{1}{r} e^{ar},$$

则有

$$u = C_1 v + C_2 w.$$

$$v'_x = v'_x \cdot r'_x = e^{-ar} \cdot \left(-\frac{1}{r^2} - \frac{a}{r} \right) \cdot \frac{x}{r}$$

$$= -xv \cdot \left(\frac{1}{r^2} + \frac{a}{r} \right),$$

$$v''_{xx} = -v'_x \cdot \left(\frac{1}{r^2} + \frac{a}{r} \right) x - v \cdot \left(-\frac{2}{r^3} - \frac{a}{r^2} \right)$$

$$\begin{aligned}
& \cdot \frac{x}{r} \cdot x - v \cdot \left(\frac{1}{r^2} + \frac{a}{r} \right) \\
& = x^2 v \cdot \left(\frac{1}{r^2} + \frac{a}{r} \right)^2 + x^2 v \cdot \frac{1}{r} \\
& \quad \cdot \left(\frac{2}{r^3} + \frac{a}{r^2} \right) - v \cdot \left(\frac{1}{r^2} + \frac{a}{r} \right) \\
& = v \cdot \left[\left(\frac{3}{r^4} + \frac{3a}{r^3} + \frac{a^2}{r^2} \right) x^2 - \frac{1}{r^2} - \frac{a}{r} \right].
\end{aligned}$$

利用对称性，即得

$$\begin{aligned}
\Delta v & = v \cdot \left[\left(\frac{3}{r^4} + \frac{3a}{r^3} + \frac{a^2}{r^2} \right) \cdot (x^2 + y^2 \right. \\
& \quad \left. + z^2) - \frac{3}{r^2} - \frac{3a}{r} \right] = a^2 v.
\end{aligned}$$

记 $b = -a$ ，则 $w = \frac{1}{r} e^{-br}$ 。仿上述证明，有

$$\Delta w = b^2 w = a^2 w.$$

于是，

$$\begin{aligned}
\Delta u & = \Delta(C_1 v + C_2 w) = C_1 \Delta v + C_2 \Delta w \\
& = C_1 a^2 v + C_2 a^2 w = a^2 u,
\end{aligned}$$

即

$$\Delta u = a^2 u.$$

3314. 设函数 $u_1 = u_1(x, y, z)$ 及 $u_2 = u_2(x, y, z)$ 满足拉普拉

$$\Delta(\Delta v) = 0.$$

证 利用 3306 题的结果, 即得

$$\begin{aligned} \Delta v &= \Delta u_1 + (x^2 + y^2 + z^2) \Delta u_2 \\ &\quad + u_2 \cdot \Delta(x^2 + y^2 + z^2) + 2\left(2x \frac{\partial u_2}{\partial x} \right. \\ &\quad \left. + 2y \frac{\partial u_2}{\partial y} + 2z \frac{\partial u_2}{\partial z}\right) \\ &= 6u_2 + 4\left(x \frac{\partial u_2}{\partial x} + y \frac{\partial u_2}{\partial y} + z \frac{\partial u_2}{\partial z}\right). \end{aligned}$$

重复应用同一结果于 Δv , 得

$$\begin{aligned} \Delta(\Delta v) &= 6\Delta u_2 + 4\left\{x\Delta\left(\frac{\partial u_2}{\partial x}\right) + y\Delta\left(\frac{\partial u_2}{\partial y}\right) \right. \\ &\quad \left. + z\Delta\left(\frac{\partial u_2}{\partial z}\right) + \frac{\partial u_2}{\partial x}\Delta x + \frac{\partial u_2}{\partial y}\Delta y \right. \\ &\quad \left. + \frac{\partial u_2}{\partial z}\Delta z + 2\left(\frac{\partial^2 u_2}{\partial x^2} + \frac{\partial^2 u_2}{\partial y^2} + \frac{\partial^2 u_2}{\partial z^2}\right)\right\}. \end{aligned}$$

由于

$$\begin{aligned} \Delta\left(\frac{\partial u_2}{\partial x}\right) &= \frac{\partial^2}{\partial x^2}\left(\frac{\partial u_2}{\partial x}\right) + \frac{\partial^2}{\partial y^2}\left(\frac{\partial u_2}{\partial x}\right) \\ &\quad + \frac{\partial^2}{\partial z^2}\left(\frac{\partial u_2}{\partial x}\right) \\ &= \frac{\partial}{\partial x}\left(\frac{\partial^2 u_2}{\partial x^2} + \frac{\partial^2 u_2}{\partial y^2} + \frac{\partial^2 u_2}{\partial z^2}\right) = \frac{\partial}{\partial x}(\Delta u_2) = 0, \\ \Delta\left(\frac{\partial u_2}{\partial y}\right) &= 0, \quad \Delta\left(\frac{\partial u_2}{\partial z}\right) = 0, \end{aligned}$$

故最后证得

$$\Delta(\Delta v) = 0.$$

3315. 设 $f(x, y, z)$ 是可微分 m 次的 n 次齐次函数. 证明

$$\begin{aligned} & \left(x \frac{\partial}{\partial x} + y \frac{\partial}{\partial y} + z \frac{\partial}{\partial z} \right)^m f(x, y, z) \\ &= n(n-1)\cdots(n-m+1)f(x, y, z). \end{aligned}$$

证 证法一

根据齐次函数的定义知, 函数 $f(x, y, z)$ 满足

$$f(tx, ty, tz) = t^n f(x, y, z). \quad (1)$$

在(1)式两端分别对 t 求 m 次导数. 首先考察 $\frac{d^m f}{dt^m}$. 由求全导数的公式知

$$\begin{aligned} \frac{df}{dt} &= x \frac{\partial f}{\partial (xt)} + y \frac{\partial f}{\partial (yt)} + z \frac{\partial f}{\partial (zt)} \\ &= t^{n-1} \left(x \frac{\partial}{\partial x} + y \frac{\partial}{\partial y} + z \frac{\partial}{\partial z} \right) f(x, y, z). \\ \frac{d^2 f}{dt^2} &= \frac{d}{dt} \left(\frac{df}{dt} \right) = x \left\{ x \frac{\partial^2 f}{\partial (xt)^2} \right. \\ &\quad \left. + y \frac{\partial^2 f}{\partial (xt) \partial (yt)} + z \frac{\partial^2 f}{\partial (xt) \partial (zt)} \right\} \\ &\quad + y \left\{ x \frac{\partial^2 f}{\partial (yt) \partial (xt)} + y \frac{\partial^2 f}{\partial (yt)^2} + z \frac{\partial^2 f}{\partial (yt) \partial (zt)} \right\} \\ &\quad + z \left\{ x \frac{\partial^2 f}{\partial (zt) \partial (xt)} + y \frac{\partial^2 f}{\partial (zt) \partial (yt)} + z \frac{\partial^2 f}{\partial (zt)^2} \right\} \end{aligned}$$

$$\begin{aligned}
&= x^2 \frac{\partial^2 f}{\partial (xt)^2} + y^2 \frac{\partial^2 f}{\partial (yt)^2} + z^2 \frac{\partial^2 f}{\partial (zt)^2} \\
&\quad + 2xy \frac{\partial^2 f}{\partial (xt)\partial (yt)} + 2yz \frac{\partial^2 f}{\partial (yt)\partial (zt)} \\
&\quad + 2zx \frac{\partial^2 f}{\partial (zt)\partial (xt)} \\
&= t^{n-2} \left(x \frac{\partial}{\partial x} + y \frac{\partial}{\partial y} + z \frac{\partial}{\partial z} \right)^2 f(x, y, z).
\end{aligned}$$

一般地，由数学归纳法可得

$$\begin{aligned}
\frac{d^m f}{dt^m} &= \sum_{\alpha_1 + \alpha_2 + \alpha_3 = m} C_{\alpha_1, \alpha_2, \alpha_3} \frac{\partial^m f}{\partial (xt)^{\alpha_1} \partial (yt)^{\alpha_2} \partial (zt)^{\alpha_3}} \\
&\quad \cdot x^{\alpha_1} y^{\alpha_2} z^{\alpha_3} \\
&= t^{n-m} \left(x \frac{\partial}{\partial x} + y \frac{\partial}{\partial y} + z \frac{\partial}{\partial z} \right)^m f(x, y, z), \quad (2)
\end{aligned}$$

其中总和是关于 $\alpha_1 + \alpha_2 + \alpha_3 = m$ 的非负整数 $\alpha_1, \alpha_2, \alpha_3$ 的一切可能组合而取的，且

$$C_{\alpha_1, \alpha_2, \alpha_3} = \frac{m!}{\alpha_1! \alpha_2! \alpha_3!}.$$

而(1)式右端对 t 求 m 次导数，得

$$\begin{aligned}
[t^m f(x, y, z)]^{(m)} &= n(n-1)\cdots(n-m \\
&\quad + 1)t^{n-m} f(x, y, z). \quad (3)
\end{aligned}$$

比较(2)式和(3)式，令 $t=1$ ，即证得

$$\left(x \frac{\partial}{\partial x} + y \frac{\partial}{\partial y} + z \frac{\partial}{\partial z} \right)^m f(x, y, z)$$

$$=n(n-1)\cdots(n-m+1)f(x, y, z).$$

证法二

当 $m=1$ 时, 则由

$$f(tx, ty, tz) = t^n f(x, y, z)$$

两端对 t 求导, 可得

$$\begin{aligned} x \frac{\partial f(tx, ty, tz)}{\partial(tx)} + y \frac{\partial f(tx, ty, tz)}{\partial(ty)} \\ + z \frac{\partial f(tx, ty, tz)}{\partial(tz)} \end{aligned}$$

$$= nt^{n-1} f(x, y, z) \quad (t > 0).$$

令 $t=1$, 即有

$$\left(x \frac{\partial}{\partial x} + y \frac{\partial}{\partial y} + z \frac{\partial}{\partial z}\right)^1 f = nf.$$

当 $m=2$ 时, 由 3234 题的结果知

$$\left(x \frac{\partial}{\partial x} + y \frac{\partial}{\partial y} + z \frac{\partial}{\partial z}\right)^2 f = n(n-1)f.$$

在 3233 题中已证得 $f'_x(x, y, z), f'_y(x, y, z),$

$f'_z(x, y, z)$ 为 $(n-1)$ 次的齐次函数.

今设 $m=k-1$ 时命题为真. 对 f'_x, f'_y, f'_z 用数

学归纳法的假设, 即

$$\left(x \frac{\partial}{\partial x} + y \frac{\partial}{\partial y} + z \frac{\partial}{\partial z}\right)^{k-1} f'_i$$

$$= (n-1)(n-2)\cdots(n-k+1)f'_x, \quad (4)$$

$$\left(x \frac{\partial}{\partial x} + y \frac{\partial}{\partial y} + z \frac{\partial}{\partial z}\right)^{k-1} f'_y$$

$$= (n-1)(n-2)\cdots(n-k+1)f'_y, \quad (5)$$

$$\left(x \frac{\partial}{\partial x} + y \frac{\partial}{\partial y} + z \frac{\partial}{\partial z}\right)^{k-1} f'_z$$

$$= (n-1)(n-2)\cdots(n-k+1)f'_z. \quad (6)$$

将(4)两端乘以 x , (5)式两端乘以 y , (6)式两端乘以 z , 然后相加, 即得

$$\left(x \frac{\partial}{\partial x} + y \frac{\partial}{\partial y} + z \frac{\partial}{\partial z}\right)^k f(x, y, z)$$

$$= (n-1)(n-2)\cdots(n-k+1) \left(x \frac{\partial}{\partial x}$$

$$+ y \frac{\partial}{\partial y} + z \frac{\partial}{\partial z}\right) f(x, y, z).$$

$$= n(n-1)(n-2)\cdots(n-k+1)f(x, y, z).$$

即当 $m=k$ 时命题也为真.

于是, 命题对于一切自然数 m 为真, 即

$$\left(x \frac{\partial}{\partial x} + y \frac{\partial}{\partial y} + z \frac{\partial}{\partial z}\right)^n f$$

$$= n(n-1)\cdots(n-k+1)f.$$

3316. 若

$z = \sin y + f(\sin x - \sin y)$,
 其中 f 为可微分的函数. 简化式子

$$\sec x \frac{\partial z}{\partial x} + \sec y \frac{\partial z}{\partial y}.$$

解
$$\sec x \frac{\partial z}{\partial x} + \sec y \frac{\partial z}{\partial y} = \sec x \cos x \cdot f'$$

$$+ \sec y \cdot (\cos y - \cos y \cdot f')$$

$$= f' + 1 - f' = 1,$$

即

$$\sec x \frac{\partial z}{\partial x} + \sec y \frac{\partial z}{\partial y} = 1.$$

3317. 证明: 函数

$$z = x^n f\left(\frac{y}{x^2}\right)$$

(其中 f 为任意的可微分函数) 满足方程

$$x \frac{\partial z}{\partial x} + 2y \frac{\partial z}{\partial y} = nz.$$

证
$$x \frac{\partial z}{\partial x} + 2y \frac{\partial z}{\partial y} = x \left\{ nx^{n-1} f\left(\frac{y}{x^2}\right) \right.$$

$$\left. - \frac{2x^n y}{x^3} f'\left(\frac{y}{x^2}\right) \right\} + 2y \frac{x^n}{x^2} f'\left(\frac{y}{x^2}\right)$$

$$= nx^n f\left(\frac{y}{x^2}\right) = nz,$$

即

$$x \frac{\partial z}{\partial x} + 2y \frac{\partial z}{\partial y} = nz.$$

3318. 证明:

$$z = yf(x^2 - y^2)$$

(其中 f 为任意的可微分函数) 满足方程

$$y^2 \frac{\partial z}{\partial x} + xy \frac{\partial z}{\partial y} = xz.$$

证 $y^2 \frac{\partial z}{\partial x} + xy \frac{\partial z}{\partial y} = y^2 \cdot 2xyf' + xy \cdot (f$
 $- 2y^2 f') = xyz = xz,$

即

$$y^2 \frac{\partial z}{\partial x} + xy \frac{\partial z}{\partial y} = xz.$$

3319. 若

$$u = \frac{1}{12}x^4 - \frac{1}{6}x^3(y+z) + \frac{1}{2}x^2yz$$

$$+ f(y-x, z-x),$$

式中 f 为可微分的函数. 简化式子

$$\frac{\partial u}{\partial x} + \frac{\partial u}{\partial y} + \frac{\partial u}{\partial z}.$$

解 $\frac{\partial u}{\partial x} = \frac{1}{3}x^3 - \frac{1}{2}x^2(y+z) + xyz - f'_1 - f'_2,$

$$\frac{\partial u}{\partial y} = -\frac{1}{6}x^3 + \frac{1}{2}x^2z + f'_1,$$

$$\frac{\partial u}{\partial z} = -\frac{1}{6}x^3 + \frac{1}{2}x^2y + f'_2.$$

将上述三式相加，即得

$$\frac{\partial u}{\partial x} + \frac{\partial u}{\partial y} + \frac{\partial u}{\partial z} = xyz.$$

3320. 设：

$$x^2 = vw, \quad y^2 = uw, \quad z^2 = uv$$

及

$$f(x, y, z) = F(u, v, w).$$

证明：

$$xf'_x + yf'_y + zf'_z = uF'_u + vF'_v + wF'_w.$$

证 把 u, v, w 当作自变量^{*)}，故

$$uF'_u = uf'_x \cdot x'_u + uf'_y \cdot y'_u + uf'_z \cdot z'_u,$$

$$vF'_v = vf'_x \cdot x'_v + vf'_y \cdot y'_v + vf'_z \cdot z'_v,$$

$$wF'_w = wf'_x \cdot x'_w + wf'_y \cdot y'_w + wf'_z \cdot z'_w.$$

将上述三式相加，得

$$uF'_u + vF'_v + wF'_w = (ux'_u + vx'_v + wx'_w) f'_x$$

$$+ (uy'_u + vy'_v + wy'_w) f'_y + (uz'_u$$

$$+vz'_y + wz'_w) f'_z. \quad (1)$$

由题设得 $2x \frac{\partial x}{\partial u} = 0$ 。因为 x 不恒等于零，所以 $\frac{\partial x}{\partial u}$

$= 0$ 。同法可得 $\frac{\partial y}{\partial v} = 0$, $\frac{\partial z}{\partial w} = 0$ 。

再由题设，得

$$2x \frac{\partial x}{\partial w} = v, \quad 2x \frac{\partial x}{\partial v} = w, \quad 2y \frac{\partial y}{\partial u} = w,$$

$$2y \frac{\partial y}{\partial w} = u, \quad 2x \frac{\partial z}{\partial u} = v, \quad 2x \frac{\partial z}{\partial v} = u.$$

将上述结果代入 (1) 式，得

$$\begin{aligned} uF'_x + vF'_y + wF'_w &= \left(\frac{vw}{2x} + \frac{wv}{2x} \right) f'_z \\ &+ \left(\frac{uw}{2y} + \frac{wu}{2y} \right) f'_y + \left(\frac{uv}{2z} + \frac{vu}{2z} \right) f'_x \\ &= xf'_x + yf'_y + zf'_z. \end{aligned}$$

即

$$uF'_x + vF'_y + wF'_w = xf'_x + yf'_y + zf'_z.$$

*) 如果把 x, y, z 当作自变量，也可以证明本题的结果。

假定任意函数 φ, ψ 等等为可微分足够多次的函数，

验证下列等式:

$$3321. \quad y \frac{\partial z}{\partial x} - x \frac{\partial z}{\partial y} = 0, \text{ 若 } z = \varphi(x^2 + y^2).$$

证 由于

$$y \frac{\partial z}{\partial x} = y \cdot 2x\varphi'(x^2 + y^2),$$

$$x \frac{\partial z}{\partial y} = x \cdot 2y\varphi'(x^2 + y^2),$$

所以

$$y \frac{\partial z}{\partial x} - x \frac{\partial z}{\partial y} = 0.$$

$$3322. \quad x^2 \frac{\partial z}{\partial x} - xy \frac{\partial z}{\partial y} + y^2 = 0, \text{ 若 } z = \frac{y^2}{3x} + \varphi(xy).$$

$$\text{证 } x^2 \frac{\partial z}{\partial x} - xy \frac{\partial z}{\partial y} + y^2 = x^2 \cdot \left[-\frac{y^2}{3x^2} + y\varphi'(xy) \right]$$

$$-xy \cdot \left[\frac{2y}{3x} + x\varphi'(xy) \right] + y^2 = 0.$$

$$3323. \quad (x^2 - y^2) \frac{\partial z}{\partial x} + xy \frac{\partial z}{\partial y} = xyz, \text{ 若 } z = e^x \varphi\left(ye^{\frac{x^2}{2y^2}}\right).$$

$$\text{证 } (x^2 - y^2) \frac{\partial z}{\partial x} + xy \frac{\partial z}{\partial y} = (x^2 - y^2) e^x \cdot \frac{x\varphi'}{y^2} ye^{\frac{x^2}{2y^2}}$$

$$+ xy \cdot \left\{ e^x \cdot \varphi + e^x \varphi' \cdot \left[e^{\frac{x^2}{2y^2}} - \frac{x^2}{y^3} ye^{\frac{x^2}{2y^2}} \right] \right\}$$

$$= xye^x \varphi = xyz.$$

$$3324. \quad x \frac{\partial u}{\partial x} + \alpha y \frac{\partial u}{\partial y} + \beta z \frac{\partial u}{\partial z} = nu, \text{ 若 } u = x^\alpha \varphi\left(\frac{y}{x^\alpha}, \frac{z}{x^\beta}\right).$$

$$\begin{aligned} \text{证} \quad x \frac{\partial u}{\partial x} + \alpha y \frac{\partial u}{\partial y} + \beta z \frac{\partial u}{\partial z} &= nx^n \varphi - \alpha x^{n-\alpha} y \varphi'_1 \\ &\quad - \beta x^{n-\beta} z \varphi'_2 + \alpha y x^{n-\alpha} \varphi'_1 + \beta z x^{n-\beta} \varphi'_2 \\ &= nx^n \varphi = nu. \end{aligned}$$

$$3325. \quad x \frac{\partial u}{\partial x} + y \frac{\partial u}{\partial y} + z \frac{\partial u}{\partial z} = u + \frac{xy}{z}, \text{ 若}$$

$$u = \frac{xy}{z} \ln x + x \varphi\left(\frac{y}{x}, \frac{z}{x}\right).$$

$$\begin{aligned} \text{证} \quad x \frac{\partial u}{\partial x} &= x \cdot \frac{y}{z} \ln x + \frac{xy}{z} + x\varphi - y\varphi'_1 - z\varphi'_2, \\ y \frac{\partial u}{\partial y} &= \frac{xy}{z} \ln x + y\varphi'_1, \quad z \frac{\partial u}{\partial z} = -\frac{xy}{z} \ln x + z\varphi'_2. \end{aligned}$$

将上述三式相加，即得

$$x \frac{\partial u}{\partial x} + y \frac{\partial u}{\partial y} + z \frac{\partial u}{\partial z} = u + \frac{xy}{z}.$$

$$3326. \quad \frac{\partial^2 u}{\partial t^2} = a^2 \frac{\partial^2 u}{\partial x^2}, \text{ 若 } u = \varphi(x-at) + \psi(x+at).$$

$$\text{证} \quad \frac{\partial^2 u}{\partial t^2} = a^2 \varphi'' + a^2 \psi'', \quad \frac{\partial^2 u}{\partial x^2} = \varphi'' + \psi''.$$

将上述二式比较，即得

$$\frac{\partial^2 u}{\partial t^2} = a^2 \frac{\partial^2 u}{\partial x^2}.$$

$$3327. \quad \frac{\partial^2 u}{\partial x^2} - 2 \frac{\partial^2 u}{\partial x \partial y} + \frac{\partial^2 u}{\partial y^2} = 0, \text{ 若}$$

$$u = x\varphi(x+y) + y\psi(x+y).$$

$$\text{证} \quad \frac{\partial u}{\partial x} = \varphi + y\psi' + x\varphi', \quad \frac{\partial u}{\partial y} = x\varphi' + \psi + y\psi',$$

$$\frac{\partial^2 u}{\partial x^2} = 2\varphi' + y\psi'' + x\varphi'', \quad (1)$$

$$\frac{\partial^2 u}{\partial x \partial y} = \varphi' + \psi' + y\psi'' + x\varphi'', \quad (2)$$

$$\frac{\partial^2 u}{\partial y^2} = x\varphi'' + 2\psi' + y\psi''. \quad (3)$$

(1) - 2 × (2) + (3), 即得

$$\frac{\partial^2 u}{\partial x^2} - 2 \frac{\partial^2 u}{\partial x \partial y} + \frac{\partial^2 u}{\partial y^2} = 0.$$

3328. $x^2 \frac{\partial^2 u}{\partial x^2} + 2xy \frac{\partial^2 u}{\partial x \partial y} + y^2 \frac{\partial^2 u}{\partial y^2} = 0$, 若

$$u = \varphi\left(\frac{y}{x}\right) + x\psi\left(\frac{y}{x}\right).$$

证 $u_1 = \varphi\left(\frac{y}{x}\right)$ 为零次齐次函数, $u_2 = x\psi\left(\frac{y}{x}\right)$ 为一次齐次函数. 由 3234 题的结果 (对于二元更成立) 知

$$\left(x \frac{\partial}{\partial x} + y \frac{\partial}{\partial y}\right)^2 u_1 = 0, \quad \left(x \frac{\partial}{\partial x} + y \frac{\partial}{\partial y}\right)^2 u_2 = 0.$$

于是,

$$x^2 \frac{\partial^2 u}{\partial x^2} + 2xy \frac{\partial^2 u}{\partial x \partial y} + y^2 \frac{\partial^2 u}{\partial y^2}$$

$$\begin{aligned}
&= \left(x \frac{\partial}{\partial x} + y \frac{\partial}{\partial y}\right)^2 (u_1 + u_2) \\
&= \left(x \frac{\partial}{\partial x} + y \frac{\partial}{\partial y}\right)^2 u_1 + \left(x \frac{\partial}{\partial x} + y \frac{\partial}{\partial y}\right)^2 u_2 \\
&= 0 + 0 = 0.
\end{aligned}$$

注. 也可不引用3234题的结果, 求出偏导数直接验证.

3329. $x^2 \frac{\partial^2 u}{\partial x^2} + 2xy \frac{\partial^2 u}{\partial x \partial y} + y^2 \frac{\partial^2 u}{\partial y^2} = n(n-1)u$, 若

$$u = x^n \varphi\left(\frac{y}{x}\right) + x^{1-n} \psi\left(\frac{y}{x}\right).$$

证 $u_1 = x^n \varphi\left(\frac{y}{x}\right)$ 为 n 次齐次函数, $u_2 = x^{1-n} \psi\left(\frac{y}{x}\right)$

为 $1-n$ 次齐次函数. 由 3234 题的结果知

$$\left(x \frac{\partial}{\partial x} + y \frac{\partial}{\partial y}\right)^2 u_1 = n(n-1)u_1,$$

$$\left(x \frac{\partial}{\partial x} + y \frac{\partial}{\partial y}\right)^2 u_2 = (1-n)(1-n-1)u_2$$

$$= n(n-1)u_2.$$

于是,

$$\begin{aligned}
&x^2 \frac{\partial^2 u}{\partial x^2} + 2xy \frac{\partial^2 u}{\partial x \partial y} + y^2 \frac{\partial^2 u}{\partial y^2} \\
&= \left(x \frac{\partial}{\partial x} + y \frac{\partial}{\partial y}\right)^2 (u_1 + u_2)
\end{aligned}$$

$$= n(n-1)(u_1 + u_2) = n(n-1)u.$$

值得注意的是, 3328 题即为本题的特殊情形:

$$n = 0.$$

$$3330. \quad \frac{\partial u}{\partial x} \frac{\partial^2 u}{\partial x \partial y} = \frac{\partial u}{\partial y} \frac{\partial^2 u}{\partial x^2}, \text{ 若 } u = \varphi(x + \psi(y)).$$

$$\text{证 } \frac{\partial u}{\partial x} = \varphi', \quad \frac{\partial^2 u}{\partial x \partial y} = \varphi'' \psi',$$

$$\frac{\partial u}{\partial y} = \varphi' \psi', \quad \frac{\partial^2 u}{\partial x^2} = \varphi''.$$

于是,

$$\frac{\partial u}{\partial x} \frac{\partial^2 u}{\partial x \partial y} = \frac{\partial u}{\partial y} \frac{\partial^2 u}{\partial x^2}.$$

用逐次微分的方法消去任意函数 φ 和 ψ ,

$$3331. \quad z = x + \varphi(xy).$$

$$\text{解 } \frac{\partial z}{\partial x} = 1 + y\varphi', \quad \frac{\partial z}{\partial y} = x\varphi'.$$

于是,

$$x \frac{\partial z}{\partial x} - y \frac{\partial z}{\partial y} = x.$$

$$3332. \quad z = x\varphi\left(\frac{x}{y^2}\right).$$

$$\text{解 } \frac{\partial z}{\partial x} = \varphi + \frac{x}{y^2} \varphi', \quad \frac{\partial z}{\partial y} = -\frac{2x^2}{y^3} \varphi'.$$

于是,

$$2x \frac{\partial z}{\partial x} + y \frac{\partial z}{\partial y} = 2x\varphi + \frac{2x^2}{y^2}\varphi' - \frac{2x^2}{y^2}\varphi'$$

$$= 2x\varphi = 2z,$$

即

$$2x \frac{\partial z}{\partial x} + y \frac{\partial z}{\partial y} = 2z.$$

3333. $z = \varphi(\sqrt{x^2 + y^2}).$

解 $\frac{\partial z}{\partial x} = \frac{x\varphi'}{\sqrt{x^2 + y^2}}, \frac{\partial z}{\partial y} = \frac{y\varphi'}{\sqrt{x^2 + y^2}}.$

于是,

$$y \frac{\partial z}{\partial x} - x \frac{\partial z}{\partial y} = 0.$$

3334. $u = \varphi(x - y, y - z).$

解 $\frac{\partial u}{\partial x} = \varphi'_1, \frac{\partial u}{\partial y} = -\varphi'_1 + \varphi'_2, \frac{\partial u}{\partial z} = -\varphi'_2.$

于是,

$$\frac{\partial u}{\partial x} + \frac{\partial u}{\partial y} + \frac{\partial u}{\partial z} = 0.$$

3335. $u = \varphi\left(\frac{x}{y}, \frac{y}{z}\right).$

解 $\frac{\partial u}{\partial x} = \frac{1}{y}\varphi'_1, \frac{\partial u}{\partial y} = -\frac{x}{y^2}\varphi'_1 + \frac{1}{z}\varphi'_2,$

$$\frac{\partial u}{\partial z} = -\frac{y}{z^2}\varphi'_2.$$

于是,

$$x \frac{\partial u}{\partial x} + y \frac{\partial u}{\partial y} + z \frac{\partial u}{\partial z} = 0^*).$$

*) 注意到 $\varphi\left(\frac{x}{y}, \frac{y}{z}\right)$ 为零次齐次函数, 本题即 3315

题的特殊情形: $n=0$.

3336. $z = \varphi(x) + \psi(y)$.

解 $\frac{\partial z}{\partial x} = \varphi'(x)$. 于是,

$$\frac{\partial^2 z}{\partial x \partial y} = 0.$$

3337. $z = \varphi(x)\psi(y)$.

解 $\frac{\partial z}{\partial x} = \varphi' \psi$, $\frac{\partial z}{\partial y} = \varphi \psi'$, $\frac{\partial^2 z}{\partial x \partial y} = \varphi' \psi'$.

于是,

$$z \frac{\partial^2 z}{\partial x \partial y} = \frac{\partial z}{\partial x} \frac{\partial z}{\partial y}.$$

3338. $z = \varphi(x+y) + \psi(x-y)$.

解 $\frac{\partial z}{\partial x} = \varphi' + \psi'$, $\frac{\partial z}{\partial y} = \varphi' - \psi'$,

$$\frac{\partial^2 z}{\partial x^2} = \varphi'' + \psi'', \quad \frac{\partial^2 z}{\partial y^2} = \varphi'' + \psi''.$$

于是,

$$\frac{\partial^2 z}{\partial x^2} = \frac{\partial^2 z}{\partial y^2}.$$

3339. $z = x\varphi\left(\frac{x}{y}\right) + y\psi\left(\frac{x}{y}\right).$

解 注意到函数 z 为一次齐次函数, 由3315题知

$$x \frac{\partial z}{\partial x} + y \frac{\partial z}{\partial y} = z.$$

3340. $z = \varphi(xy) + \psi\left(\frac{x}{y}\right).$

解 设 $z_1 = \varphi(xy)$, 则由3331题知

$$x \frac{\partial z_1}{\partial x} - y \frac{\partial z_1}{\partial y} = 0.$$

又 $z_2 = \psi\left(\frac{x}{y}\right)$ 为零次齐次函数, 且函数

$$x \frac{\partial z_2}{\partial x} - y \frac{\partial z_2}{\partial y} = \frac{2x}{y} \psi'$$

也为零次齐次函数. 从而, 函数

$$\begin{aligned} u = x \frac{\partial z}{\partial x} - y \frac{\partial z}{\partial y} &= \left(x \frac{\partial z_1}{\partial x} - y \frac{\partial z_1}{\partial y} \right) \\ &+ \left(x \frac{\partial z_2}{\partial x} - y \frac{\partial z_2}{\partial y} \right) \end{aligned}$$

是零次齐次函数. 于是, 由3315题知

$$x \frac{\partial u}{\partial x} + y \frac{\partial u}{\partial y} = 0.$$

但是,

$$\begin{aligned}x \frac{\partial u}{\partial x} + y \frac{\partial u}{\partial y} &= x \frac{\partial}{\partial x} \left(x \frac{\partial z}{\partial x} - y \frac{\partial z}{\partial y} \right) \\ &+ y \frac{\partial}{\partial y} \left(x \frac{\partial z}{\partial x} - y \frac{\partial z}{\partial y} \right) \\ &= x^2 \frac{\partial^2 z}{\partial x^2} + x \frac{\partial z}{\partial x} - xy \frac{\partial^2 z}{\partial x \partial y} + xy \frac{\partial^2 z}{\partial x \partial y} \\ &\quad - y \frac{\partial z}{\partial y} - y^2 \frac{\partial^2 z}{\partial y^2} \\ &= x^2 \frac{\partial^2 z}{\partial x^2} - y^2 \frac{\partial^2 z}{\partial y^2} + x \frac{\partial z}{\partial x} - y \frac{\partial z}{\partial y},\end{aligned}$$

故得

$$x^2 \frac{\partial^2 z}{\partial x^2} - y^2 \frac{\partial^2 z}{\partial y^2} + x \frac{\partial z}{\partial x} - y \frac{\partial z}{\partial y} = 0.$$

3341. 求函数

$$z = x^2 - y^2$$

在点 $M(1, 1)$ 沿与 Ox 轴的正向组成角 $\alpha = 60^\circ$ 的方向 l 上的导函数.

解 $\left. \frac{\partial z}{\partial x} \right|_{x=1, y=1} = 2, \quad \left. \frac{\partial z}{\partial y} \right|_{x=1, y=1} = -2.$

$$\cos \alpha = \cos 60^\circ = \frac{1}{2}, \quad \cos \beta = \cos 30^\circ = \frac{\sqrt{3}}{2}.$$

于是,

$$\left. \frac{\partial z}{\partial l} \right|_{x=1, y=1} = 2 \cdot \frac{1}{2} + (-2) \cdot \frac{\sqrt{3}}{2} = 1 - \sqrt{3}.$$

3342. 求函数

$$z = x^2 - xy + y^2$$

在点 $M(1, 1)$ 沿与 Ox 轴的正向组成 α 角的方向 l 上的导函数. 在怎样的方向上此导函数有: (a) 最大的值; (b) 最小的值; (B) 等于 0.

解 $\frac{\partial z}{\partial x} \Big|_{\substack{x=1 \\ y=1}} = 1, \frac{\partial z}{\partial y} \Big|_{\substack{x=1 \\ y=1}} = 1$. 于是,

$$\begin{aligned} \frac{\partial z}{\partial l} \Big|_{\substack{x=1 \\ y=1}} &= \cos\alpha + \cos(90^\circ - \alpha) = \cos\alpha + \sin\alpha \\ &= \sqrt{2} \sin\left(\alpha + \frac{\pi}{4}\right). \end{aligned}$$

(a) 当 $\sin\left(\alpha + \frac{\pi}{4}\right) = 1$, 即 $\alpha = \frac{\pi}{4}$ 时, $\frac{\partial z}{\partial l}$ 最大;

(b) 当 $\sin\left(\alpha + \frac{\pi}{4}\right) = -1$, 即 $\alpha = \frac{5\pi}{4}$ 时, $\frac{\partial z}{\partial l}$ 最

小;

(B) 当 $\sin\left(\alpha + \frac{\pi}{4}\right) = 0$, 即 $\alpha = \frac{3\pi}{4}$ 或 $\alpha = \frac{7\pi}{4}$

时, $\frac{\partial z}{\partial l} = 0$.

3343. 求函数

$$z = \ln(x^2 + y^2)$$

在点 $M_0(x_0, y_0)$ 沿与过此点的等位线成垂直的方向上的导数.

解 与等位线垂直的方向即梯度的方向或与梯度相反

的方向。于是，

$$\begin{aligned} \frac{\partial z}{\partial l} \Big|_{\substack{x=x_0 \\ y=y_0}} &= \pm |\operatorname{grad} z| \Big|_{\substack{x=x_0 \\ y=y_0}} \\ &= \pm \sqrt{\left(\frac{\partial z}{\partial x}\right)^2 + \left(\frac{\partial z}{\partial y}\right)^2} \Big|_{\substack{x=x_0 \\ y=y_0}} \\ &= \pm \sqrt{\left(\frac{2x_0}{x_0^2 + y_0^2}\right)^2 + \left(\frac{2y_0}{x_0^2 + y_0^2}\right)^2} = \pm \frac{2}{\sqrt{x_0^2 + y_0^2}}. \end{aligned}$$

3344. 求函数

$$z = 1 - \left(\frac{x^2}{a^2} + \frac{y^2}{b^2}\right)$$

在点 $M\left(\frac{a}{\sqrt{2}}, \frac{b}{\sqrt{2}}\right)$ 沿曲线 $\frac{x^2}{a^2} + \frac{y^2}{b^2} = 1$ 在此点的内法线方向上的导数。

解 曲线 $\frac{x^2}{a^2} + \frac{y^2}{b^2} = 1$ 是函数 z 的一条等位线。随着 x, y 的绝对值增大， z 是减少的，因此，曲线的内法线方向即梯度方向。于是，

$$\begin{aligned} \frac{\partial z}{\partial l} \Big|_{\substack{x=\frac{a}{\sqrt{2}} \\ y=\frac{b}{\sqrt{2}}}} &= |\operatorname{grad} z| \Big|_{\substack{x=\frac{a}{\sqrt{2}} \\ y=\frac{b}{\sqrt{2}}}} = \sqrt{\frac{4x^2}{a^4} + \frac{4y^2}{b^4}} \Big|_{\substack{x=\frac{a}{\sqrt{2}} \\ y=\frac{b}{\sqrt{2}}}} \\ &= \frac{\sqrt{2(a^2 + b^2)}}{ab} \quad (a > 0, b > 0). \end{aligned}$$

3345. 求函数

$$u = xyz$$

在点 $M(1,1,1)$ 沿方向 $l\{\cos\alpha, \cos\beta, \cos\gamma\}$ 上的导数. 函数在该点的梯度的大小等于甚么?

$$\text{解 } \left. \frac{\partial u}{\partial l} \right|_{\substack{x=1 \\ y=1 \\ z=1}} = \cos\alpha + \cos\beta + \cos\gamma.$$

$$\begin{aligned} |\text{grad } u| \Big|_{\substack{x=1 \\ y=1 \\ z=1}} &= \sqrt{\left(\frac{\partial u}{\partial x}\right)^2 + \left(\frac{\partial u}{\partial y}\right)^2 + \left(\frac{\partial u}{\partial z}\right)^2} \Big|_{\substack{x=1 \\ y=1 \\ z=1}} \\ &= \sqrt{3}. \end{aligned}$$

3346. 求函数

$$u = \frac{1}{r}$$

(式中 $r = \sqrt{x^2 + y^2 + z^2}$) 在点 $M_0(x_0, y_0, z_0)$ 处梯度的大小和方向.

$$\text{解 } \frac{\partial u}{\partial x} = -\frac{x}{r^3}, \quad \frac{\partial u}{\partial y} = -\frac{y}{r^3}, \quad \frac{\partial u}{\partial z} = -\frac{z}{r^3}. \quad \text{于是,}$$

$$\text{grad } u = -\frac{1}{r^3} (x\vec{i} + y\vec{j} + z\vec{k})$$

或简记成

$$\text{grad } u = \left\{ -\frac{x}{r^3}, -\frac{y}{r^3}, -\frac{z}{r^3} \right\}.$$

在点 M_0 处的梯度为

$$\text{grad } u = \left\{ -\frac{x_0}{r_0^3}, -\frac{y_0}{r_0^3}, -\frac{z_0}{r_0^3} \right\},$$

其中 $r_0 = \sqrt{x_0^2 + y_0^2 + z_0^2}$. 从而得

$$|\text{grad } u| = \sqrt{\left(-\frac{x_0}{r_0^3}\right)^2 + \left(-\frac{y_0}{r_0^3}\right)^2 + \left(-\frac{z_0}{r_0^3}\right)^2}$$

$$= \frac{1}{r_0^2},$$

$$\cos(\text{grad } u \hat{x}) = \frac{-\frac{x_0}{r_0^3}}{\frac{1}{r_0^2}} = -\frac{x_0}{r_0},$$

$$\cos(\text{grad } u \hat{y}) = \frac{-\frac{y_0}{r_0^3}}{\frac{1}{r_0^2}} = -\frac{y_0}{r_0},$$

$$\cos(\text{grad } u \hat{z}) = \frac{-\frac{z_0}{r_0^3}}{\frac{1}{r_0^2}} = -\frac{z_0}{r_0}.$$

3347. 求函数

$$u = x^2 + y^2 - z^2$$

在点 $A(\varepsilon, 0, 0)$ 及 $B(0, \varepsilon, 0)$ 二点的梯度之间的角度.

解 $\text{grad } u = \left\{ \frac{\partial u}{\partial x}, \frac{\partial u}{\partial y}, \frac{\partial u}{\partial z} \right\} = \{2x, 2y, -2z\}$. 若

以 $\text{grad } u_A$ 及 $\text{grad } u_B$ 分别表示在 A 点及 B 点的梯度, 则有

$$\text{grad } u_A = \{2\varepsilon, 0, 0\}, \quad \text{grad } u_B = \{0, 2\varepsilon, 0\}.$$

由于

$$\text{grad } u_A \cdot \text{grad } u_B = 2\varepsilon \cdot 0 + 0 \cdot 2\varepsilon + 0 \cdot 0 = 0,$$

故知

$$\text{grad } u_A \perp \text{grad } u_B,$$

即在点 A 及点 B 二点的梯度之间的夹角为

$$(\widehat{\text{grad } u_A}, \text{grad } u_B) = \frac{\pi}{2}.$$

3348⁺. 在点 $M(1, 2, 2)$ 处, 函数

$$u = x + y + z$$

的梯度之大小与函数

$$v = x + y + z + 0.001 \sin(10^6 \pi \sqrt{x^2 + y^2 + z^2})$$

的梯度之大小相差若干?

解 $\text{grad } u = \{1, 1, 1\}$, $|\text{grad } u| = \sqrt{3}$.

令 $r = \sqrt{x^2 + y^2 + z^2}$, 则

$$\frac{\partial v}{\partial x} = 1 + 1000\pi \frac{x}{r} \cos(10^6 \pi r),$$

$$\frac{\partial v}{\partial y} = 1 + 1000\pi \frac{y}{r} \cos(10^6 \pi r),$$

$$\frac{\partial v}{\partial z} = 1 + 1000\pi \frac{z}{r} \cos(10^6 \pi r).$$

在点 $M(1, 2, 2)$ 处,

$$\frac{\partial v}{\partial x} = \frac{1000\pi}{3} + 1 \approx \frac{1000\pi}{3},$$

$$\frac{\partial v}{\partial y} = \frac{2000\pi}{3} + 1 \approx \frac{2000\pi}{3},$$

$$\frac{\partial v}{\partial z} = \frac{2000\pi}{3} + 1 \approx \frac{2000\pi}{3},$$

$$|\text{grad } v| \approx 1000\pi \sqrt{\left(\frac{1}{3}\right)^2 + \left(\frac{2}{3}\right)^2 + \left(\frac{2}{3}\right)^2}$$

$$= 1000\pi.$$

于是，两梯度之大小相差为

$$|\text{grad } v| - |\text{grad } u| \approx 1000\pi - \sqrt{3} \approx 3140.$$

3349. 证明：在点 $M_0(x_0, y_0, z_0)$ 处函数

$$u = ax^2 + by^2 + cz^2$$

及

$$v = ax^2 + by^2 + cz^2 + 2mx + 2ny + 2pz$$

(a, b, c, m, n, p 为常数且 $a^2 + b^2 + c^2 \neq 0$) 二者的梯度之间的角度当点 M_0 无限远移时趋于零。

证 本题的题设条件“点 $M_0(x_0, y_0, z_0)$ 无限远移”应理解为“ $x_0 \rightarrow \infty, y_0 \rightarrow \infty, z_0 \rightarrow \infty$ 同时成立”（此时 $\sqrt{(ax_0)^2 + (by_0)^2 + (cz_0)^2} \rightarrow +\infty$ ），否则，本题的结论不成立。

显见有

$$\text{grad } u = \{2ax_0, 2by_0, 2cz_0\},$$

$$\text{grad } v = \{2ax_0 + 2m, 2by_0 + 2n, 2cz_0 + 2p\}.$$

令 $\alpha = ax_0, \beta = by_0, \gamma = cz_0$;

$$\alpha_1 = ax_0 + m = \alpha + m, \beta_1 = by_0 + n = \beta + n, \gamma_1 = cz_0 + p = \gamma + p.$$

于是， $\text{grad } u$ 与 $\text{grad } v$ 的夹角 θ 满足

$$\cos \theta = \frac{\alpha\alpha_1 + \beta\beta_1 + \gamma\gamma_1}{\sqrt{\alpha^2 + \beta^2 + \gamma^2} \cdot \sqrt{\alpha_1^2 + \beta_1^2 + \gamma_1^2}}$$

或

$$\begin{aligned} \sin^2 \theta &= 1 - \cos^2 \theta \\ &= \frac{(\alpha^2 + \beta^2 + \gamma^2)(\alpha_1^2 + \beta_1^2 + \gamma_1^2) - (\alpha\alpha_1 + \beta\beta_1 + \gamma\gamma_1)^2}{(\alpha^2 + \beta^2 + \gamma^2)(\alpha_1^2 + \beta_1^2 + \gamma_1^2)} \end{aligned}$$

$$\begin{aligned}
&= \frac{(a\beta_1 - a_1\beta)^2 + (a\gamma_1 - a_1\gamma)^2 + (\beta\gamma_1 - \beta_1\gamma)^2}{(a^2 + \beta^2 + \gamma^2)(a_1^2 + \beta_1^2 + \gamma_1^2)} \\
&= \frac{(na - m\beta)^2 + (pa - m\gamma)^2 + (p\beta - n\gamma)^2}{(a^2 + \beta^2 + \gamma^2)(a_1^2 + \beta_1^2 + \gamma_1^2)}.
\end{aligned}$$

令 $\delta = \max(|ax_0|, |by_0|, |cz_0|)$
 $= \max(|a|, |\beta|, |\gamma|)$, 则
 $\delta \leq \sqrt{a^2 + \beta^2 + \gamma^2} \leq \sqrt{3}\delta$.

于是, 当 $\sqrt{a^2 + \beta^2 + \gamma^2} \rightarrow +\infty$ 时, $\delta \rightarrow +\infty$.

再令 $q = \max(|m|, |n|, |p|)$, 则下述不等式显然成立:

$$\begin{aligned}
0 \leq \sin^2 \theta &= \frac{(na - m\beta)^2 + (pa - m\gamma)^2 + (p\beta - n\gamma)^2}{(a^2 + \beta^2 + \gamma^2)(a_1^2 + \beta_1^2 + \gamma_1^2)} \\
&\leq \frac{(2q\delta)^2 + (2q\delta)^2 + (2q\delta)^2}{\delta^2(\delta^2 - 6\delta q - 3q^2)} \\
&= \frac{12q^2}{\delta^2 - 6\delta q - 3q^2} \rightarrow 0 \quad (\text{当 } \delta \rightarrow +\infty \text{ 时}).
\end{aligned}$$

于是, 当 $\sqrt{a^2 + \beta^2 + \gamma^2} \rightarrow +\infty$ 时, $\sin^2 \theta \rightarrow 0$, 即当 $\sqrt{a^2 + \beta^2 + \gamma^2} \rightarrow +\infty$, $\theta \rightarrow 0$. 证毕.

3350. 设 $u = f(x, y, z)$ 为可微分两次的函数. 若 $\cos \alpha, \cos \beta,$

$\cos \gamma$ 为方向 l 的方向余弦, 求 $\frac{\partial^2 u}{\partial l^2} = \frac{\partial}{\partial l} \left(\frac{\partial u}{\partial l} \right)$.

解 $\frac{\partial u}{\partial l} = \frac{\partial u}{\partial x} \cos \alpha + \frac{\partial u}{\partial y} \cos \beta + \frac{\partial u}{\partial z} \cos \gamma,$

$$\frac{\partial^2 u}{\partial l^2} = \left(\frac{\partial^2 u}{\partial x^2} \cos \alpha + \frac{\partial^2 u}{\partial y \partial x} \cos \beta + \right.$$

$$\begin{aligned}
& \left. \frac{\partial^2 u}{\partial z \partial x} \cos \gamma \right) \cos \alpha \\
& + \left(\frac{\partial^2 u}{\partial x \partial y} \cos \alpha + \frac{\partial^2 u}{\partial y^2} \cos \beta + \frac{\partial^2 u}{\partial z \partial y} \cos \gamma \right) \cos \beta \\
& + \left(\frac{\partial^2 u}{\partial x \partial z} \cos \alpha + \frac{\partial^2 u}{\partial y \partial z} \cos \beta + \frac{\partial^2 u}{\partial z^2} \cos \gamma \right) \cos \gamma \\
= & \frac{\partial^2 u}{\partial x^2} \cos^2 \alpha + \frac{\partial^2 u}{\partial y^2} \cos^2 \beta + \frac{\partial^2 u}{\partial z^2} \cos^2 \gamma \\
& + 2 \frac{\partial^2 u}{\partial x \partial y} \cos \alpha \cos \beta \\
& + 2 \frac{\partial^2 u}{\partial y \partial z} \cos \beta \cos \gamma + 2 \frac{\partial^2 u}{\partial z \partial x} \cos \gamma \cos \alpha.
\end{aligned}$$

3351. 设 $u=f(x, y, z)$ 为可微分两次的函数及

$$l_1 \{\cos \alpha_1, \cos \beta_1, \cos \gamma_1\}, l_2 \{\cos \alpha_2, \cos \beta_2, \cos \gamma_2\},$$

$$l_3 \{\cos \alpha_3, \cos \beta_3, \cos \gamma_3\}$$

为三个互相垂直的方向。证明：

$$(a) \left(\frac{\partial u}{\partial l_1} \right)^2 + \left(\frac{\partial u}{\partial l_2} \right)^2 + \left(\frac{\partial u}{\partial l_3} \right)^2$$

$$= \left(\frac{\partial u}{\partial x} \right)^2 + \left(\frac{\partial u}{\partial y} \right)^2 + \left(\frac{\partial u}{\partial z} \right)^2;$$

$$(b) \frac{\partial^2 u}{\partial l_1^2} + \frac{\partial^2 u}{\partial l_2^2} + \frac{\partial^2 u}{\partial l_3^2} = \frac{\partial^2 u}{\partial x^2} + \frac{\partial^2 u}{\partial y^2} + \frac{\partial^2 u}{\partial z^2}.$$

$$\text{证 (a)} \left(\frac{\partial u}{\partial l_1} \right)^2 + \left(\frac{\partial u}{\partial l_2} \right)^2 + \left(\frac{\partial u}{\partial l_3} \right)^2$$

$$\begin{aligned}
&= \sum_{i=1}^3 \left(\frac{\partial u}{\partial x} \cos \alpha_i + \frac{\partial u}{\partial y} \cos \beta_i + \frac{\partial u}{\partial z} \cos \gamma_i \right)^2 \\
&= \left(\frac{\partial u}{\partial x} \right)^2 \cdot \sum_{i=1}^3 \cos^2 \alpha_i + \left(\frac{\partial u}{\partial y} \right)^2 \cdot \sum_{i=1}^3 \cos^2 \beta_i \\
&\quad + \left(\frac{\partial u}{\partial z} \right)^2 \cdot \sum_{i=1}^3 \cos^2 \gamma_i \\
&\quad + 2 \frac{\partial u}{\partial x} \frac{\partial u}{\partial y} \cdot \sum_{i=1}^3 \cos \alpha_i \cos \beta_i \\
&\quad + 2 \frac{\partial u}{\partial y} \frac{\partial u}{\partial z} \cdot \sum_{i=1}^3 \cos \beta_i \cos \gamma_i \\
&\quad + 2 \frac{\partial u}{\partial z} \frac{\partial u}{\partial x} \cdot \sum_{i=1}^3 \cos \gamma_i \cos \alpha_i. \tag{1}
\end{aligned}$$

由于 l_1, l_2, l_3 是互相垂直的三个单位矢量，故

$$\begin{aligned}
\sum_{i=1}^3 \cos \alpha_i \cos \beta_i &= 0, \quad \sum_{i=1}^3 \cos \beta_i \cos \gamma_i = 0, \\
\sum_{i=1}^3 \cos \gamma_i \cos \alpha_i &= 0, \\
\sum_{i=1}^3 \cos^2 \alpha_i &= 1, \quad \sum_{i=1}^3 \cos^2 \beta_i = 1, \\
\sum_{i=1}^3 \cos^2 \gamma_i &= 1. \tag{2}
\end{aligned}$$

将上述诸等式 (2) 代入 (1) 式，即得

$$\begin{aligned} & \left(\frac{\partial u}{\partial l_1}\right)^2 + \left(\frac{\partial u}{\partial l_2}\right)^2 + \left(\frac{\partial u}{\partial l_3}\right)^2 \\ &= \left(\frac{\partial u}{\partial x}\right)^2 + \left(\frac{\partial u}{\partial y}\right)^2 + \left(\frac{\partial u}{\partial z}\right)^2. \end{aligned}$$

(6) 利用3350题的结果, 得

$$\begin{aligned} \sum_{i=1}^3 \frac{\partial^2 u}{\partial l_i^2} &= \frac{\partial^2 u}{\partial x^2} \cdot \sum_{i=1}^3 \cos^2 \alpha_i \\ &+ \frac{\partial^2 u}{\partial y^2} \cdot \sum_{i=1}^3 \cos^2 \beta_i + \frac{\partial^2 u}{\partial z^2} \cdot \sum_{i=1}^3 \cos^2 \gamma_i \\ &+ 2 \frac{\partial u}{\partial x} \frac{\partial u}{\partial y} \cdot \sum_{i=1}^3 \cos \alpha_i \cos \beta_i \\ &+ 2 \frac{\partial u}{\partial y} \frac{\partial u}{\partial z} \cdot \sum_{i=1}^3 \cos \beta_i \cos \gamma_i \\ &+ 2 \frac{\partial u}{\partial z} \frac{\partial u}{\partial x} \cdot \sum_{i=1}^3 \cos \gamma_i \cos \alpha_i. \end{aligned} \quad (3)$$

将诸等式(2)代入(3)式, 即得

$$\frac{\partial^2 u}{\partial l_1^2} + \frac{\partial^2 u}{\partial l_2^2} + \frac{\partial^2 u}{\partial l_3^2} = \frac{\partial^2 u}{\partial x^2} + \frac{\partial^2 u}{\partial y^2} + \frac{\partial^2 u}{\partial z^2}.$$

3352. 设 $u = u(x, y)$ 为可微分的函数且当 $y = x^2$ 时有:

$$u(x, y) = 1$$

及

$$\frac{\partial u}{\partial x} = x.$$

求当 $y = x^2$ 时的 $\frac{\partial u}{\partial y}$.

$$\text{解 } \frac{d}{dx}u(x, x^2) = \frac{\partial u}{\partial x} + \frac{\partial u}{\partial y} \frac{dy}{dx}.$$

当 $y = x^2$, $u(x, y) = u(x, x^2) = 1$, 故 $\frac{du(x, x^2)}{dx} = 0$,

且有 $\frac{\partial u}{\partial x} = x$, $\frac{dy}{dx} = 2x$. 将这些结果代入上式, 即得

$$x + 2x \frac{\partial u}{\partial y} = 0.$$

于是, $\frac{\partial u}{\partial y} = -\frac{1}{2} (x \neq 0)$.

3353. 设函数 $u = u(x, y)$ 满足方程

$$\frac{\partial^2 u}{\partial x^2} - \frac{\partial^2 u}{\partial y^2} = 0$$

以及下列条件:

$$u(x, 2x) = x, u'_x(x, 2x) = x^2.$$

求: $u''_{xx}(x, 2x)$, $u''_{xy}(x, 2x)$, $u''_{yy}(x, 2x)$.

解 由于 $u(x, 2x) = x$, 故

$$u'_x(x, 2x) + 2u'_y(x, 2x) = 1. \quad (1)$$

又因 $u'_x(x, 2x) = x^2$, 故由 (1) 式即得

$$u_y^1(x, 2x) = \frac{1-x^2}{2}. \quad (2)$$

将(2)式两端对 x 求导数, 有

$$u_{yx}^1(x, 2x) + 2u_{yy}^1(x, 2x) = -x; \quad (3)$$

由 $u_x^1(x, 2x) = x^2$ 两端对 x 求导数, 有

$$u_{xx}^1(x, 2x) + 2u_{xy}^1(x, 2x) = 2x. \quad (4)$$

联立(3)式和(4)式并利用题设条件 $u_{xx}'' = u_{yy}''$, 解之

即得

$$u_{xx}''(x, 2x) = u_{yy}''(x, 2x) = -\frac{4}{3}x,$$

$$u_{xy}''(x, 2x) = \frac{5}{3}x.$$

假定 $z = z(x, y)$, 解下列方程:

$$3354. \frac{\partial^2 z}{\partial x^2} = 0.$$

解 $\frac{\partial z}{\partial x} = \varphi(y), \quad z = x\varphi(y) + \psi(y).$

$$3355. \frac{\partial^2 z}{\partial x \partial y} = 0.$$

解 $\frac{\partial z}{\partial x} = \varphi_1(x),$

$$z = \int_0^x \varphi_1(t) dt + \psi(y) = \varphi(x) + \psi(y).$$

3356. $\frac{\partial^n z}{\partial y^n} = 0.$

解 $\frac{\partial^{n-1} z}{\partial y^{n-1}} = \bar{\varphi}_{n-1}(x),$

$$\frac{\partial^{n-2} z}{\partial y^{n-2}} = y \bar{\varphi}_{n-1}(x) + \bar{\varphi}_{n-2}(x),$$

累次积分 n 次, 最后得

$$z = y^{n-1} \bar{\varphi}_{n-1}(x) + y^{n-2} \bar{\varphi}_{n-2}(x) + \dots + y \bar{\varphi}_1(x) + \bar{\varphi}_0(x).$$

3357. 假定 $u = u(x, y, z)$ 解方程

$$\frac{\partial^3 u}{\partial x \partial y \partial z} = 0.$$

解 $\frac{\partial^2 u}{\partial x \partial y} = \varphi_1(x, y),$

$$\frac{\partial u}{\partial x} = \varphi_2(x, y) + \psi_1(x, z),$$

$$u = \varphi(x, y) + \psi(x, z) + \chi(y, z).$$

3358. 求方程

$$\frac{\partial z}{\partial y} = x^2 + 2y$$

的满足条件 $z(x, x^2) = 1$ 的解 $z = z(x, y).$

解 由 $\frac{\partial z}{\partial y} = x^2 + 2y$ 得

$$z = x^2 y + y^2 + \varphi(x).$$

又因 $z(x, x^2) = 1$, 故

$$1 = x^4 + x^4 + \varphi(x),$$

从而有

$$\varphi(x) = 1 - 2x^4.$$

最后得

$$z = 1 + x^2 y + y^2 - 2x^4.$$

3359. 求方程

$$\frac{\partial^2 z}{\partial y^2} = 2$$

的满足条件 $z(x, 0) = 1$, $z'_y(x, 0) = x$ 的解

$z = z(x, y)$.

解 由 $\frac{\partial^2 z}{\partial y^2} = 2$ 得

$$\frac{\partial z}{\partial y} = 2y + \varphi(x).$$

又因 $z'_y(x, 0) = x$, 所以

$$x = 0 + \varphi(x) \text{ 或 } x = \varphi(x).$$

从而有

$$\frac{\partial z}{\partial y} = 2y + x.$$

由此得

$$z = y^2 + xy + \varphi_1(x).$$

又因 $z(x, 0) = 1$, 故

$$1 = 0 + 0 + \varphi_1(x) \text{ 或 } 1 = \varphi_1(x).$$

最后得

$$z = 1 + xy + y^2.$$

3360. 求方程

$$\frac{\partial^2 z}{\partial x \partial y} = x + y$$

的满足条件 $z(x, 0) = x, z(0, y) = y^2$ 的解 $z = z(x, y)$.

解 由 $\frac{\partial^2 z}{\partial x \partial y} = x + y$ 得

$$\frac{\partial z}{\partial x} = xy + \frac{1}{2}y^2 + \varphi_1(x),$$

$$z = \frac{1}{2}x^2y + \frac{1}{2}xy^2 + \varphi(x) + \psi(y).$$

现确定 $\varphi(x)$ 及 $\psi(y)$. 由于 $z(x, 0) = x, z(0, y) = y^2$, 故有

$$x = \varphi(x) + \psi(0),$$

$$y^2 = \varphi(0) + \psi(y),$$

于是,

$$z = x + y^2 + \frac{1}{2}x^2y + \frac{1}{2}xy^2 - [\varphi(0) + \psi(0)].$$

又因 $z(0, 0) = 0$, 故 $\varphi(0) + \psi(0) = 0$. 最后得

$$z = x + y^2 + \frac{1}{2}xy(x + y).$$

§3. 隐函数的微分法

1° 存在定理 设: 1) 函数 $F(x, y, z)$ 在某点 $\hat{A}_0(x_0, y_0, z_0)$ 等于零; 2) $F(x, y, z)$ 和 $F'_z(x, y, z)$ 在点 \hat{A}_0 的邻域内有定义并且是连续的; 3) $F'_z(x_0, y_0, z_0) \neq 0$, 则在点 $A_0(x_0, y_0)$ 的某充分小的邻域内存在唯一的连续函数

$$z = f(x, y) \quad (1)$$

满足方程 $F(x, y, z) = 0$

而且是 $z_0 = f(x_0, y_0)$.

2° 隐函数的可微分性 设除了上面的条件外, 4) 如果函数 $F(x, y, z)$ 在点 $\hat{A}_0(x_0, y_0, z_0)$ 的邻域内可微分, 则函数 (1) 在点 $A_0(x_0, y_0)$ 的邻域内也可微分并且它的导函数 $\frac{\partial z}{\partial x}$ 和 $\frac{\partial z}{\partial y}$ 可从方程

$$\frac{\partial F}{\partial x} + \frac{\partial F}{\partial z} \frac{\partial z}{\partial x} = 0, \quad \frac{\partial F}{\partial y} + \frac{\partial F}{\partial z} \frac{\partial z}{\partial y} = 0 \quad (2)$$

求得. 若函数 $F(x, y, z)$ 可微分任意多次, 则用逐次微分方程 (2) 的方法也可计算函数 z 的高阶导函数.

3° 由方程组定义的隐函数 设函数 $F_i(x_1, \dots, x_m; y_1, \dots, y_n)$ ($i=1, 2, \dots, n$) 满足下列条件:

- (1) 于点 $\hat{A}_0(x_{10}, \dots, x_{m0}; y_{10}, \dots, y_{n0})$ 变成为零;
- (2) 在点 \hat{A}_0 的邻域内可微分;
- (3) 在点 \hat{A}_0 函数行列式 $\frac{\partial(F_1, \dots, F_n)}{\partial(y_1, \dots, y_n)} \neq 0$.

在这种情况下，方程组

$$F_i(x_1, \dots, x_m; y_1, \dots, y_n) = 0 \quad (i=1, 2, \dots, n) \quad (3)$$

在点 $A_0(x_{10}, \dots, x_{m0})$ 的邻域内唯一地确定出一组可微分的函数：

$$y_i = f_i(x_1, \dots, x_m) \quad (i=1, 2, \dots, n),$$

这些方程满足方程 (3) 及原始条件

$$f_i(x_{10}, \dots, x_{m0}) = y_{i0} \quad (i=1, 2, \dots, n).$$

这些隐函数的微分可由方程组

$$\sum_{j=1}^m \frac{\partial F_i}{\partial x_j} dx_j + \sum_{k=1}^n \frac{\partial F_i}{\partial y_k} dy_k = 0$$

($i=1, 2, \dots, n$)^{*} 求得。

3361. 证明：在每一点都不连续的迪里黑里函数

$$y = \begin{cases} 1, & \text{若 } x \text{ 为有理数;} \\ 0, & \text{若 } x \text{ 为无理数} \end{cases}$$

满足方程

$$y^2 - y = 0.$$

证 当 x 为有理数时， $y^2 - y = 1 - 1 = 0$ ；当 x 为无理数时， $y^2 - y = 0 - 0 = 0$ 。因此，不论 x 为任何实数 x ，均有

$$y^2 - y = 0.$$

3362. 设函数 $f(x)$ 定义于区间 (a, b) 内。问在怎样的情况下方程

$$f(x)y = 0$$

* 这一段在简明陈述大多数的问题时无条件地假定隐函数和它们的对应导函数存在的条件满足。

当 $a < x < b$ 时才有唯一连续的解 $y = 0$?

解 函数 $f(x)$ 的非零点的集合在区间 (a, b) 内是处处稠密的, 即 $f(x)$ 的零点的集合不能充满区间 (a, b) 的任意一个子区间 $(\alpha, \beta) \subset (a, b)$. 此时, 方程 $f(x)y = 0$ 有唯一连续的解 $y = 0$. 事实上, 设 $y = y(x)$ 为方程 $f(x)y = 0$ 的一个连续解, $x_0 \in (a, b)$, 则

(1) 当 $f(x_0) \neq 0$ 时, 显然有 $y(x_0) = 0$;

(2) 当 $f(x_0) = 0$ 时, 由 $f(x)$ 的非零点的稠密性知: 存在数列 $\{x_n\}$, 满足 $x_n \rightarrow x_0$ 及 $f(x_n) \neq 0$ ($n = 1, 2, \dots$). 于是, $y(x_n) = 0$. 由 $y(x)$ 的连续性即得

$$y(x_0) = y(\lim_{n \rightarrow \infty} x_n) = \lim_{n \rightarrow \infty} y(x_n) = 0.$$

于是, 当 $a < x < b$ 时, $y \equiv 0$.

反之, 若方程 $f(x)y = 0$ 在 (a, b) 只有唯一的连续解 $y = 0$, 则 $f(x)$ 的零点集必不能充满 (a, b) 的任何子区间. 事实上, 设在 (a, b) 的某子区间 (α, β) 上 $f(x) \equiv 0$. 定义 (a, b) 上的函数 $y_0(x)$ 如下:

$$y_0(x) = \begin{cases} 0, & \text{当 } a < x < a + \frac{\beta - a}{4} \text{ 时;} \\ \frac{4}{\beta - a} \left(x - a - \frac{\beta - a}{4} \right), & \\ \quad \text{当 } a + \frac{\beta - a}{4} \leq x < a + \frac{\beta - a}{2} \text{ 时;} \\ -\frac{4}{\beta - a} \left[x - a - \frac{3(\beta - a)}{4} \right], & \\ \quad \text{当 } a + \frac{\beta - a}{2} \leq x \leq a + \frac{3}{4}(\beta - a) \text{ 时;} \\ 0, & \text{当 } a + \frac{3}{4}(\beta - a) < x < b \text{ 时.} \end{cases}$$

如图6·27所示, 图中 $c_1 = \alpha + \frac{\beta - \alpha}{4}$, $c_0 = \alpha + \frac{\beta - \alpha}{2}$, $c_2 = \alpha + \frac{3(\beta - \alpha)}{4}$.

显然 $y_0(x) \neq 0$, 但 $y = y_0(x)$ 是方程 $f(x)y = 0$ 在 (a, b) 上的一个连续解.



图 6·27

3363. 设函数 $f(x)$ 和 $g(x)$ 于区间 (a, b) 内有定义且连续. 问在怎样的情况下, 方程

$$f(x)y = g(x)$$

于区间 (a, b) 内才有唯一连续的解.

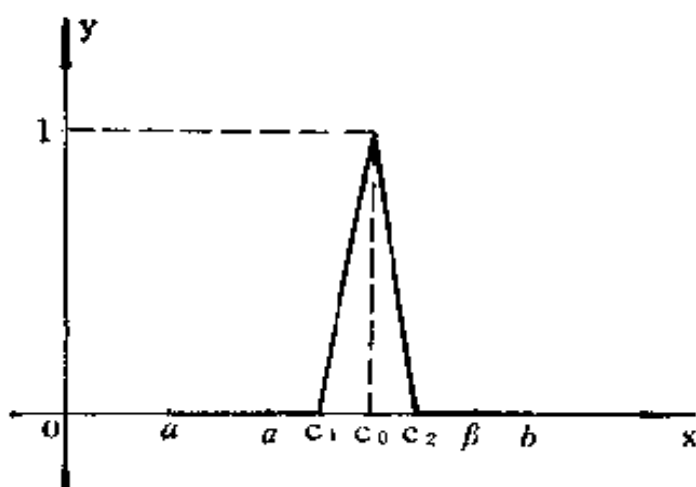
解 下面三个条件显然是必要的:

(1) $f(x)$ 的零点必须是 $g(x)$ 的零点, 否则 y 无解;

(2) $f(x)$ 的非零点集合必须在 (a, b) 内稠密. 否则, 存在 $(\alpha, \beta) \subset (a, b)$, 当 $x \in (\alpha, \beta)$ 时, 恒有 $f(x) = g(x) = 0$. 从而当 $x \in (\alpha, \beta)$ 时, 任意改变原方程

一个连续解 $y(x)$ 的函数值 (但保持连续性) 就得出原方程的另一个连续解 (参看3362题的图), 此与原方程连续解的唯一性矛盾.

(3) 如果 $f(x_0) = 0$, 则对任一点列 $x_n \rightarrow x_0$, $f(x_n) \neq 0 (n=1, 2, \dots)$, 均有

$$\lim_{n \rightarrow \infty} \frac{g(x_n)}{f(x_n)} = y_0 \quad (y_0 \text{ 是有限数且只与 } x_0 \text{ 有关}).$$

显然, 如果上述极限不存在或对不同的序列取不同的值均导致 y 不连续.

反之, 若上述三个条件满足, 我们证明原方程的连续解存在唯一. 事实上, 这时令

$$y_0(x) = \begin{cases} \frac{g(x)}{f(x)}, & \text{在 } f(x) \neq 0 \text{ 的点;} \\ \lim_{\substack{n \rightarrow \infty \\ x_n \rightarrow x, f(x_n) \neq 0}} \frac{g(x_n)}{f(x_n)}, & \text{在 } f(x) = 0 \text{ 的点, 这里任取} \\ & x_n \rightarrow x, f(x_n) \neq 0 (n=1, 2, \dots). \end{cases}$$

易知 $y_0(x)$ 是 (a, b) 内的连续函数且满足原方程, 即是原方程的一个连续解. 现若原方程在 (a, b) 内还有一连续解 $y = y_1(x)$, 则

$$f(x)y_1(x) = g(x), f(x)y_0(x) = g(x) (a < x < b).$$

对任何 $x_0 \in (a, b)$, 若 $f(x_0) \neq 0$, 则 $y_1(x_0) = \frac{g(x_0)}{f(x_0)} = y_0(x_0)$; 若 $f(x_0) = 0$, 取 $x_n \rightarrow x_0, f(x_n) \neq 0 (n=1, 2, \dots)$, 则根据 $y_1(x)$ 的连续性, 得

$$y_1(x_0) = \lim_{n \rightarrow \infty} y_1(x_n) = \lim_{n \rightarrow \infty} \frac{g(x_n)}{f(x_n)} = y_0(x_0).$$

于是, $y_1(x) \equiv y_0(x)$ ($a < x < b$). 唯一性获证.

3364. 设已知方程

$$x^2 + y^2 = 1 \quad (1)$$

及

$$y = y(x) \quad (-1 \leq x \leq 1) \quad (2)$$

为满足方程(1)的单值函数.

1) 问有多少单值函数(2)满足方程(1)?

2) 问有多少单值连续函数(2)满足方程(1)?

3) 设: (a) $y(0) = 1$; (b) $y(1) = 0$, 问有多少单值连续函数(2)满足方程(1)?

解 1) 无限个. 例如, 令

$$y_n(x) = \begin{cases} \sqrt{1-x^2}, & \text{当 } -1 \leq x \leq 1 \text{ 且 } x \neq \frac{1}{n} \text{ 时;} \\ -\sqrt{1-x^2}, & \text{当 } x = \frac{1}{n} \text{ 时} \end{cases}$$

$$(n=1, 2, 3, \dots),$$

则显然 $y = y_n(x)$ ($n=1, 2, 3, \dots$) 都是满足方程(1)的单值函数.

2) 二个: $y = -\sqrt{1-x^2}$ 及 $y = \sqrt{1-x^2}$.

3) (a) 满足条件 $y(0) = 1$ 的仅 $y = \sqrt{1-x^2}$ 这一个连续函数; (b) 满足条件 $y(1) = 0$ 的有 $y = -\sqrt{1-x^2}$ 及 $y = \sqrt{1-x^2}$ 这二个连续函数.

3365. 设已知方程

$$x^2 = y^2 \quad (1)$$

及

$$y = y(x) \quad (-\infty < x < +\infty) \quad (2)$$

是满足方程 (1) 的单值函数.

- 1) 问有多少单值函数(2)满足方程(1)?
- 2) 问有多少单值连续函数(2)满足方程(1)?
- 3) 问有多少单值可微分的函数(2)满足方程(1)?
- 4) 设: (a) $y(1)=1$; (b) $y(0)=0$, 问有多少单值连续函数(2)满足方程(1)?
- 5) 设 $y(1)=1$ 及 δ 为充分小的数, 问有多少单值连续函数 $y=y(x)$ ($1-\delta < x < 1+\delta$) 满足方程(1)?

解 1) 无限个. 例如, $y_n(x) = \begin{cases} |x|, & x \neq \frac{1}{n}; \\ -|x|, & x = \frac{1}{n}, \end{cases}$

($n=1, 2, \dots$) 都是.

2) 四个: $y=-x$, $y=x$, $y=|x|$ 和 $y=-|x|$.

3) 二个: $y=-x$ 和 $y=x$.

4) (a) 二个: $y=x$ 和 $y=|x|$; (b) 四个: 即 2) 中之四个.

5) 一个: $y=x$.

3366⁺. 方程

$$x^2 + y^2 = x^4 + y^4$$

是定义 y 为 x 的多值函数. 问这个函数在怎样的域内, 1) 单值, 2) 有二个值, 3) 有三个值, 4) 有四个值? 求此函数的各枝点及它的单值连续的各枝.

解 由 $x^2 + y^2 = x^4 + y^4$ 得 $y^4 - y^2 + (x^4 - x^2) = 0$.

解之, 得 $y^2 = \frac{1}{2} \pm \sqrt{\frac{1}{4} + x^2 - x^4}$. 一共有单值连续

的六支，其中当 $\frac{1}{4} + x^2 - x^4 \geq 0$ 即 $|x| \leq \sqrt{\frac{1+\sqrt{2}}{2}}$

时有二支：

$$y_1 = \sqrt{\frac{1}{2}} + \sqrt{\frac{1}{4} + x^2 - x^4}, \quad |x| \leq \sqrt{\frac{1+\sqrt{2}}{2}},$$

$$y_2 = -\sqrt{\frac{1}{2}} + \sqrt{\frac{1}{4} + x^2 - x^4}, \quad |x| \leq \sqrt{\frac{1+\sqrt{2}}{2}}.$$

而当 $0 \leq \frac{1}{4} + x^2 - x^4 \leq \left(\frac{1}{2}\right)^2$ 即 $1 \leq x^2 \leq \frac{1+\sqrt{2}}{2}$ 时

有四支：

$$y_3 = \sqrt{\frac{1}{2}} - \sqrt{\frac{1}{4} + x^2 - x^4}, \quad 1 \leq x \leq \sqrt{\frac{1+\sqrt{2}}{2}};$$

$$y_4 = \sqrt{\frac{1}{2}} - \sqrt{\frac{1}{4} + x^2 - x^4}, \quad -\sqrt{\frac{1+\sqrt{2}}{2}} \leq x \leq -1;$$

$$y_5 = -\sqrt{\frac{1}{2}} - \sqrt{\frac{1}{4} + x^2 - x^4}, \quad 1 \leq x \leq \sqrt{\frac{1+\sqrt{2}}{2}};$$

$$y_6 = -\sqrt{\frac{1}{2}} - \sqrt{\frac{1}{4} + x^2 - x^4},$$

$$-\sqrt{\frac{1+\sqrt{2}}{2}} \leq x \leq -1.$$

此外还有一个孤立点 $(0,0)$ (参看 1542 题的图形)。考虑上述六支的公共定义域知：

1) 没有单值区域。

2) 双值区域为 $0 < |x| < 1$ 及 $x = \pm \sqrt{\frac{1+\sqrt{2}}{2}}$ 。

3) 三值区域为 $x=0$ 及 $x=\pm 1$.

4) 四值区域为 $1 < |x| < \sqrt{\frac{1+\sqrt{2}}{2}}$.

枝点的必要条件为

$$(y^4 - y^2 + (x^4 - x^2))'_y = 0,$$

即

$$4y^3 - 2y = 0.$$

于是,

$$y = 0 \text{ 及 } y = \pm \frac{1}{\sqrt{2}}.$$

由 $y=0$ 解得 $x=0$ 及 $x=\pm 1$; 而由 $y=\pm \frac{1}{\sqrt{2}}$ 解得

$x = \pm \sqrt{\frac{1+\sqrt{2}}{2}}$. 经验证, 得六个枝点:

$$(-1, 0), (1, 0), \left(\sqrt{\frac{1+\sqrt{2}}{2}}, \frac{1}{\sqrt{2}}\right),$$

$$\left(\sqrt{\frac{1+\sqrt{2}}{2}}, -\frac{1}{\sqrt{2}}\right), \left(-\sqrt{\frac{1+\sqrt{2}}{2}}, \frac{1}{\sqrt{2}}\right),$$

$$\left(-\sqrt{\frac{1+\sqrt{2}}{2}}, -\frac{1}{\sqrt{2}}\right).$$

3367. 求由方程

$$(x^2 + y^2)^2 = x^2 - y^2$$

所定义的多值函数 y 的各枝点和单值连续的各枝 $y = y(x)$ ($-1 \leq x \leq 1$).

解 由 $(x^2 + y^2)^2 = x^2 - y^2$ 得

$$y^2 = \frac{-(1+2x^2) \pm \sqrt{8x^2+1}}{2}.$$

因为当 $|x| \leq 1$ 时, $\sqrt{8x^2+1} \geq 1+2x^2$, 故单值连续
的各枝为 (共有四枝)

$$y = \varepsilon(x) \sqrt{\frac{\sqrt{8x^2+1} - (1+2x^2)}{2}} \quad (-1 \leq x \leq 1),$$

其中 $\varepsilon(x)$ 分别为 $1, -1, \operatorname{sgn} x, -\operatorname{sgn} x$.

下面再求枝点:

$$\left[(x^2+y^2)^2 - x^2 + y^2 \right]'_y = 2(x^2+y^2) \cdot 2y + 2y = 0,$$

解之得 $y=0$, 从而得 $x=0$ 及 $x=\pm 1$. 经验证得枝
点为

$$(0, 0), (1, 0) \text{ 及 } (-1, 0).$$

3368. 设函数 $f(x)$ 当 $a < x < b$ 时连续, 并且函数 $\varphi(y)$ 当
 $c < y < d$ 时单调增加而且连续. 问在怎样的条件下
方程

$$\varphi(y) = f(x)$$

定义出单值函数

$$y = \varphi^{-1}[f(x)]?$$

研究例子: (a) $\sin y + \operatorname{sh} y = x$; (b) $e^{-y} = -\sin^2 x$.

解 根据 $\varphi(y)$ 的严格增加性以及 $\varphi(y)$ 、 $f(x)$ 的连续
性可知, 若存在 (x_0, y_0) 满足 $\varphi(y_0) = f(x_0)$, 则在 x_0 近
旁由方程 $\varphi(y) = f(x)$ 可唯一地确定 y 为 x 的单值连
续函数

$$y = \varphi^{-1}[f(x)] \quad (\text{满足 } y_0 = \varphi^{-1}[f(x_0)]); \quad (1)$$

若更设满足不等式

$$\lim_{y \rightarrow c+0} \varphi(y) < f(x) < \lim_{y \rightarrow d-0} \varphi(y) \quad (a < x < b), \quad (2)$$

则显然函数(1)是整个 $a < x < b$ 上定义的连续函数.

$$(a) \text{ 设 } \varphi(y) = \sin y + \operatorname{sh} y \quad (-\infty < y < +\infty),$$

$f(x)=x$ ($-\infty < x < +\infty$). 由于 $\varphi'(y)=\cos y + \operatorname{ch} y > 0$ ($-\infty < y < +\infty$), 故 $\varphi(y)$ 是 $-\infty < y < +\infty$ 上的严格增函数, 又显然有

$$\lim_{y \rightarrow -\infty} \varphi(y) = -\infty, \quad \lim_{y \rightarrow +\infty} \varphi(y) = +\infty,$$

故不等式(2)满足. 于是, 由方程 $\sin y + \operatorname{sh} y = x$ 唯一确定 y 为 x 的连续函数, 它定义在整个数轴: $-\infty < x < +\infty$ 上.

(6) $\varphi(y) = e^{-y}$ 及 $f(x) = -\sin^2 x$ 虽然也满足题设条件, 但此方程是矛盾的 ($e^{-y} > 0$, $-\sin^2 x \leq 0$), 即不存在点 (x_0, y_0) , 使有 $e^{-y_0} = -\sin^2 x_0$. 因此, 不能定义 y 为 x 的单值函数.

3369. 设:

$$x = y + \varphi(y), \quad (1)$$

其中 $\varphi(0) = 0$ 且当 $-a < y < a$ 时 $\varphi'(y)$ 连续并满足 $|\varphi'(y)| \leq k < 1$. 证明: 当 $-\varepsilon < x < \varepsilon$ 时存在唯一的可微分函数 $y = y(x)$ 满足方程(1)且 $y(0) = 0$.

证 设 $F(x, y) = x - y - \varphi(y)$, 则

1) 由于 $\varphi(0) = 0$, 故 $F(0, 0) = 0$;

2) 当 $-\infty < x < +\infty$, $-a < y < a$ 时, $F(x, y)$, $F'_x(x, y)$ 及 $F'_y(x, y) = -1 - \varphi'(y)$ 均连续;

3) $F'_y(0, 0) = -1 - \varphi'(0) < 0$, 当然 $F'_y(0, 0) \neq 0$.

于是, 由隐函数的存在及可微性定理知: 存在 $\varepsilon > 0$, 使当 $-\varepsilon < x < \varepsilon$ 时, 存在唯一的可微分函数 $y = y(x)$ 满足方程 $x = y + \varphi(y)$ 及 $y(0) = 0$.

3370. 设 $y = y(x)$ 为由方程

$$x = ky + \varphi(y)$$

所定义的隐函数，其中常数 $k \neq 0$ 且 $\varphi(y)$ 为以 ω 为周期的可微周期函数，且 $|\varphi'(y)| < |k|$ 。证明

$$y = \frac{x}{k} + \psi(x),$$

其中 $\psi(x)$ 为以 $|k|\omega$ 为周期的周期函数。

证 由于 $x = ky + \varphi(y)$ ，故 $\frac{dx}{dy} = k + \varphi'(y)$ 。又因

$|\varphi'(y)| < |k|$ ，故 $\frac{dx}{dy}$ 与 k 同号，即 x 为 y 的严格

单调函数，且为连续的。由于 $\varphi(y)$ 是连续的以 ω 为周期的函数，故有界，从而当 $k > 0$ 时，

$$\lim_{y \rightarrow -\infty} x = -\infty, \quad \lim_{y \rightarrow +\infty} x = +\infty;$$

当 $k < 0$ 时，

$$\lim_{y \rightarrow -\infty} x = +\infty, \quad \lim_{y \rightarrow +\infty} x = -\infty;$$

由此可知，其反函数 $y = y(x)$ 存在唯一，且是 $-\infty < x < +\infty$ 上有定义的严格单调可微函数。令

$$y(x) - \frac{x}{k} = \psi(x) \quad (-\infty < x < +\infty), \quad (1)$$

则由 $x = ky(x) + \varphi[y(x)]$ ， $\varphi[y(x) + \omega] = \varphi[y(x)]$ 知 $x + k\omega = ky(x) + \varphi[y(x)] + k\omega = k[y(x) + \omega] + \varphi[y(x) + \omega]$ 。从而，根据反函数的唯一性，得

$$y(x + k\omega) = y(x) + \omega \quad (-\infty < x < +\infty). \quad (2)$$

由 (1) 式与 (2) 式，得

$$\psi(x + k\omega) = y(x + k\omega) - \frac{x + k\omega}{k} = y(x) - \frac{x}{k}$$

$$= \psi(x) \quad (-\infty < x < +\infty).$$

同理可证

$$\psi(x - k\omega) = \psi(x) \quad (-\infty < x < +\infty),$$

故 $\psi(x)$ 是以 $|k|\omega$ 为周期的可微周期函数. 由(1)得

$$y = y(x) = \frac{1}{k}x + \psi(x).$$

证毕.

对于由下列各方程式所定义的函数 y , 求出 y' 和 y'' :

3371. $x^2 + 2xy - y^2 = a^2.$

解 用求导数及微分两种方法解之.

解法一

等式两端分别对 x 求导数, 得

$$2x + 2y + 2xy' - 2yy' = 0,$$

故有

$$y' = \frac{y+x}{y-x}.$$

再对上式求导数, 得

$$\begin{aligned} y'' &= \frac{(y-x)(y'+1) - (y+x)(y'-1)}{(y-x)^2} \\ &= \frac{2y - 2xy'}{(y-x)^2} = \frac{2y(y-x) - 2x(y+x)}{(y-x)^3} \\ &= \frac{2(y^2 - 2xy - x^2)}{(y-x)^3} = -\frac{2a^2}{(y-x)^3} = \frac{2a^2}{(x-y)^3}. \end{aligned}$$

解法二

等式两端分别微分，得

$$2xdx + 2xdy + 2ydx - 2ydy = 0, \quad (1)$$

故有

$$\frac{dy}{dx} = \frac{y+x}{y-x}.$$

对(1)式两端再微分一次，并注意 $d^2x = 0$ ，得

$$dx^2 + 2dxdy - dy^2 + (x-y)d^2y = 0,$$

故有

$$\begin{aligned} \frac{d^2y}{dx^2} &= \frac{1 + 2\frac{dy}{dx} - \left(\frac{dy}{dx}\right)^2}{y-x} = \frac{1 + \frac{2(y+x)}{y-x} - \left(\frac{y+x}{y-x}\right)^2}{y-x} \\ &= \frac{2a^2}{(x-y)^3}. \end{aligned}$$

$$3372. \ln\sqrt{x^2+y^2} = \operatorname{arc\,tg} \frac{y}{x}.$$

解 解法一

等式两端对 x 求导数，得

$$\frac{x+yy'}{x^2+y^2} = \frac{xy'-y}{x^2+y^2}.$$

解之即得

$$y' = \frac{x+y}{x-y}.$$

将上式再对 x 求导数，得

$$y'' = \frac{(x-y)(1+y') - (x+y)(1-y')}{(x-y)^2}$$

$$\begin{aligned}
&= \frac{2(xy' - y)}{(x-y)^2} \\
&= \frac{2x(x+y) - 2y(x-y)}{(x-y)^3} = \frac{2(x^2 + y^2)}{(x-y)^3}.
\end{aligned}$$

解法二

等式两端分别微分，得

$$\frac{x dx + y dy}{x^2 + y^2} = \frac{x dy - y dx}{x^2 + y^2}.$$

解之即得

$$\frac{dy}{dx} = \frac{x+y}{x-y}.$$

对 $x dx + y dy = x dy - y dx$ 再微分一次，得

$$dx^2 + dy^2 + y d^2 y = x d y^2,$$

故有

$$\begin{aligned}
\frac{d^2 y}{dx^2} &= \frac{1}{x-y} \left[1 + \left(\frac{dy}{dx} \right)^2 \right] \\
&= \frac{(x-y)^2 + (x+y)^2}{(x-y)^3} = \frac{2(x^2 + y^2)}{(x-y)^3}.
\end{aligned}$$

以下各题根据情况采用直接求导法或微分法.

3373. $y - \varepsilon \sin y = x \quad (0 < \varepsilon < 1).$

解 等式两端对 x 求导数，得

$$y' - \varepsilon y' \cos y = 1,$$

故有

$$y' = \frac{1}{1 - \varepsilon \cos y}$$

将上式再对 x 求导数, 得

$$y'' = -\frac{\varepsilon y' \sin y}{(1 - \varepsilon \cos y)^2} = -\frac{\varepsilon \sin y}{(1 - \varepsilon \cos y)^3}.$$

3374. $x^2 = y^x$ ($x \neq y$).

解 取对数得

$$y \ln x = x \ln y \text{ 或 } \frac{\ln x}{x} = \frac{\ln y}{y} \quad (x > 0, y > 0).$$

两端对 x 求导数, 得

$$\frac{1 - \ln x}{x^2} = \frac{y'(1 - \ln y)}{y^2},$$

故有

$$y' = \frac{y^2(1 - \ln x)}{x^2(1 - \ln y)}.$$

将上式再对 x 求导数, 得

$$\begin{aligned} y'' &= \frac{1}{x^4(1 - \ln y)^2} \left\{ x^2(1 - \ln y) \left[2yy'(1 - \ln x) \right. \right. \\ &\quad \left. \left. - \frac{y^2}{x} \right] - y^2(1 - \ln x) \left[2x - 2x \ln y - \frac{x^2 y'}{y} \right] \right\} \\ &= \frac{1}{x^4(1 - \ln y)^3} \left\{ y^2 \left[y(1 - \ln x)^2 - 2(x - y) \right. \right. \\ &\quad \left. \left. \cdot (1 - \ln x)(1 - \ln y) - x(1 - \ln y)^2 \right] \right\}. \end{aligned}$$

3375. $y = 2x \operatorname{arc} \operatorname{tg} \frac{y}{x}$.

解 $\frac{y}{x} = 2 \operatorname{arctg} \frac{y}{x}$, 显然 $\frac{y}{x} \neq 1$.

两端微分, 得

$$d\left(\frac{y}{x}\right) = \frac{2d\left(\frac{y}{x}\right)}{1 + \left(\frac{y}{x}\right)^2}.$$

于是, $d\left(\frac{y}{x}\right) = 0$, 即 $\frac{xdy - ydx}{x^2} = 0$, 故有

$$\frac{dy}{dx} = \frac{y}{x}.$$

将上式对 x 求导数, 即得

$$\frac{d^2y}{dx^2} = \frac{x \frac{dy}{dx} - y}{x^2} = 0.$$

3376. 证明: 当

$$1 + xy = k(x - y)$$

(式中 k 为常数) 时, 有等式

$$\frac{dx}{1+x^2} = \frac{dy}{1+y^2}.$$

证 将等式 $1 + xy = k(x - y)$ 两端微分, 得

$$xdy + ydx = k(dx - dy),$$

故

$$\begin{aligned} (x-y)(xdy + ydx) &= k(x-y)(dx - dy) \\ &= (1+xy)(dx - dy), \end{aligned}$$

简化即得

$$\frac{dx}{1+x^2} = \frac{dy}{1+y^2}.$$

证毕.

3377. 证明: 若

$$x^2y^2 + x^2 + y^2 - 1 = 0,$$

则当 $xy > 0$ 时有等式

$$\frac{dx}{\sqrt{1-x^4}} + \frac{dy}{\sqrt{1-y^4}} = 0.$$

证 将所给等式两端微分, 得

$$2xy^2dx + 2x^2ydy + 2xdx + 2ydy = 0,$$

即

$$x(y^2+1)dx + y(x^2+1)dy = 0. \quad (1)$$

由 $x^2y^2 + x^2 + y^2 - 1 = 0$ 可解得

$$x = \pm \sqrt{\frac{1-y^2}{1+y^2}}, \quad y = \pm \sqrt{\frac{1-x^2}{1+x^2}}. \quad (2)$$

因为 $xy > 0$, 故知 x, y 应同取正号或同取负号. 不论取什么符号, 当用(2)式代入(1)式后, 均可得

$$\frac{dx}{\sqrt{1-x^4}} + \frac{dy}{\sqrt{1-y^4}} = 0.$$

3378. 证明: 方程

$$(x^2 + y^2)^2 = a^2(x^2 - y^2) \quad (a \neq 0)$$

在点 $x=0, y=0$ 的邻域中定义两个可微分的函数:

$y=y_1(x)$ 和 $y=y_2(x)$. 求 $y'_1(0)$ 及 $y'_2(0)$.

解 $(x^2 + y^2)^2 = a^2(x^2 - y^2)$ 即

$$y^4 + (2x^2 + a^2)y^2 - (a^2x^2 - x^4) = 0.$$

解之得

$$y^2 = \frac{-(2x^2 + a^2) + \sqrt{8a^2x^2 + a^4}}{2}$$

(根号前取正号是由于 $y^2 \geq 0$)。记

$$y = \pm \sqrt{\frac{\sqrt{8a^2x^2 + a^4} - 2x^2 - a^2}{2}} = \pm f(x^2).$$

不难看出 $(0,0)$ 为枝点。从点 $(0,0)$ 出发，有单值连续
的四个分枝：

$$y_{\text{I}} = f(x^2), \quad 0 \leq x \leq \delta;$$

$$y_{\text{II}} = f(x^2), \quad -\delta \leq x \leq 0;$$

$$y_{\text{III}} = -f(x^2), \quad 0 \leq x \leq \delta;$$

$$y_{\text{IV}} = -f(x^2), \quad -\delta \leq x \leq 0.$$

这几个单值分枝能否组成 $(-\delta, \delta)$ 上的可微分函数，
主要是看组成的函数在 $x=0$ 是否可微。为此，研究
各分枝在点 $x=0$ 处的单侧导数。

$$\begin{aligned} y'_{\text{I}+}(0) &= \lim_{x \rightarrow +0} \frac{y_{\text{I}}(x) - y_{\text{I}}(0)}{x - 0} = \lim_{x \rightarrow +0} \frac{f(x^2)}{x} \\ &= \lim_{x \rightarrow +0} \frac{1}{x} \sqrt{\frac{\sqrt{8a^2x^2 + a^4} - 2x^2 - a^2}{2}} \\ &= \lim_{x \rightarrow +0} \sqrt{\frac{\sqrt{8a^2x^2 + a^4} - 2x^2 - a^2}{2x^2}} \\ &= \lim_{x \rightarrow +0} \sqrt{\frac{8a^2x^2 + a^4 - (2x^2 + a^2)^2}{2x^2(\sqrt{8a^2x^2 + a^4} + 2x^2 + a^2)}} \end{aligned}$$

$$= \lim_{x \rightarrow +0} \sqrt{\frac{4a^2 - 4x^2}{2(\sqrt{8a^2x^2 + a^4 + 2x^2 + a^2})}} = 1.$$

同法可得

$$y'_{\text{I}^-}(0) = \lim_{x \rightarrow -0} \frac{f(x^2)}{x} = -1,$$

$$y'_{\text{II}^+}(0) = \lim_{x \rightarrow +0} \frac{-f(x^2)}{x} = -1,$$

$$y'_{\text{IV}^-}(0) = \lim_{x \rightarrow -0} \frac{-f(x^2)}{x} = 1.$$

由上可以看出

$$y_1(x) = \begin{cases} f(x^2), & 0 \leq x < \delta, \\ -f(x^2), & -\delta < x < 0, \end{cases}$$

及

$$y_2(x) = \begin{cases} -f(x^2), & 0 \leq x < \delta, \\ f(x^2), & -\delta < x < 0 \end{cases}$$

是仅有的两个过点 $(0, 0)$ 的可微分函数, 且 $y'_1(0) = 1$ 及 $y'_2(0) = -1$.

*) 此方程的图象系双纽线 (图 6·28), 它的极坐标方程为 $r^2 = a^2 \cos 2\theta$. 以上作法及结论由图很容易看



图 6·28

出.

3379. 设:

$$(x^2 + y^2)^2 = 3x^2y - y^3,$$

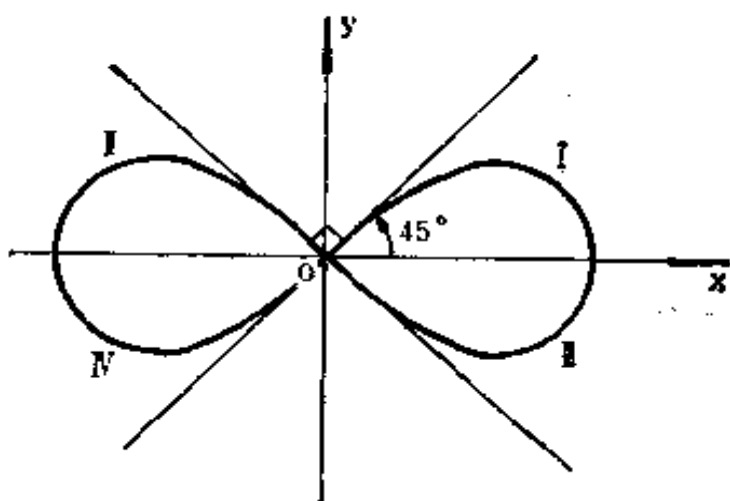
求 y' 当 $x=0$ 和 $y=0$ 时的值.

解 本题讨论方法与 3378 题类似, 但由于不能直接解出 $y=f(x)$, 故只能用隐函数表示. 由 $(x^2 + y^2)^2 = 3x^2y - y^3$ 得

$$x^4 + (2y^2 - 3y)x^2 + y^4 + y^3 = 0.$$

解之得

$$x^2 = \frac{(3y - 2y^2) \pm \sqrt{9y^2 - 16y^3}}{2}.$$

令

$$g(y) = \frac{3y - 2y^2 + \sqrt{9y^2 - 16y^3}}{2},$$

$$h(y) = \frac{3y - 2y^2 - \sqrt{9y^2 - 16y^3}}{2},$$

则不难验证: 在 $y=0$ 的邻域内均有 $g(y) \geq 0$; 而仅当 $y \geq 0$ 时才有 $h(y) \geq 0$. 于是, 点 $(0, 0)$ 为枝点, 且从该点出发, 有六个单值连续枝:

I. $x_1 = \sqrt{g(y)}$, $0 \leq y < \varepsilon$; 它在 $0 \leq x < \delta$ 上定义隐函数 $y = f_1(x)$.

II. $x_2 = -\sqrt{g(y)}$, $0 \leq y < \varepsilon$; 它在 $-\delta < x \leq 0$ 上定义隐函数 $y = f_2(x)$.

III. $x_3 = \sqrt{h(y)}$, $-\varepsilon < y \leq 0$; 它在 $0 \leq x < \delta$ 上定义隐函数 $y = f_3(x)$.

IV. $x_4 = -\sqrt{h(y)}$, $-\varepsilon < y \leq 0$; 它在 $-\delta < x \leq 0$

上定义隐函数 $y=f_4(x)$.

V. $x_5=\sqrt{h(y)}$, $0\leq y<\varepsilon$; 它在 $0\leq x<\delta$ 上定义隐函数 $y=f_5(x)$.

VI. $x_6=-\sqrt{h(y)}$, $0\leq y<\varepsilon$; 它在 $-\delta<x\leq 0$ 上定义隐函数 $y=f_6(x)$.

上述隐函数的存在性, 易从对右端 y 的表达式求导数而导数不为零获证. 因此, 只要求上述六枝在原点的单侧导数.

$$\begin{aligned} f'_{1+}(0) &= \lim_{x\rightarrow+0} \frac{f_1(x)-f_1(0)}{x-0} = \lim_{y\rightarrow+0} \frac{y}{\sqrt{g(y)}} \\ &= \lim_{y\rightarrow+0} \sqrt{\frac{2y^2}{3y-2y^2+\sqrt{9y^2-16y^3}}} \\ &= \lim_{y\rightarrow+0} \sqrt{\frac{2y}{3-2y+\sqrt{9-16y}}} = 0. \end{aligned}$$

$$f'_{2-}(0) = \lim_{x\rightarrow-0} \frac{f_2(x)-f_2(0)}{x-0} = \lim_{y\rightarrow+0} \frac{y}{-\sqrt{g(y)}} = 0.$$

$$\begin{aligned} f'_{3+}(0) &= \lim_{x\rightarrow+0} \frac{f_3(x)-f_3(0)}{x-0} = \lim_{z\rightarrow+0} \frac{y}{\sqrt{g(y)}} \\ &= \lim_{z\rightarrow+0} \frac{-z}{\sqrt{g(-z)}} \\ &= -\lim_{z\rightarrow+0} \sqrt{\frac{2z^2}{\sqrt{9z^2+16z^3}-3z-2z^2}} \\ &= -\lim_{z\rightarrow+0} \sqrt{\frac{2z^2(\sqrt{9z^2+16z^3}+3z+2z^2)}{(9z^2+16z^3)-(3z+2z^2)^2}} \end{aligned}$$

$$= -\lim_{z \rightarrow +0} \sqrt{\frac{2(\sqrt{9+16z+3+2z})}{4-4z}} = -\sqrt{3}.$$

$$\begin{aligned} f'_{4-}(0) &= \lim_{x \rightarrow -0} \frac{f_4(x)}{x} = \lim_{y \rightarrow -0} \frac{y}{-\sqrt{g(y)}} \\ &= -(-\sqrt{3}) = \sqrt{3}. \end{aligned}$$

$$\begin{aligned} f'_{5+}(0) &= \lim_{x \rightarrow +0} \frac{f_5(x)}{x} = \lim_{y \rightarrow +0} \frac{y}{\sqrt{h(y)}} \\ &= \lim_{y \rightarrow +0} \sqrt{\frac{2y^2}{3y-2y^2-\sqrt{9y^2-16y^3}}} \\ &= \lim_{y \rightarrow +0} \sqrt{\frac{2y^2(3y-2y^2+\sqrt{9y^2-16y^3})}{(3y-2y^2)^2-(9y^2-16y^3)}} \\ &= \lim_{y \rightarrow +0} \sqrt{\frac{2(3-2y+\sqrt{9-16y})}{4+4y}} = \sqrt{3}. \end{aligned}$$

$$f'_{6-}(0) = \lim_{x \rightarrow -0} \frac{f_6(x)}{x} = \lim_{y \rightarrow +0} \frac{y}{-\sqrt{h(y)}} = -\sqrt{3}.$$

于是，上述六个单值连续枝可组成三个 $(-\delta, \delta)$ 上的可微函数 $y = y_i(x)$ ($i=1, 2, 3$):

$$\begin{aligned} y_1(x) &= \begin{cases} f_1(x), & x \geq 0 \\ f_2(x), & x < 0 \end{cases}, & y'_1(0) &= 0; \\ y_2(x) &= \begin{cases} f_5(x), & x \geq 0 \\ f_6(x), & x < 0 \end{cases}, & y'_2(0) &= -\sqrt{3}; \\ y_3(x) &= \begin{cases} f_3(x), & x \geq 0 \\ f_4(x), & x < 0 \end{cases}, & y'_3(0) &= \sqrt{3}. \end{aligned}$$

*) 此方程的图象为三瓣玫瑰线 (图 6·29), 它的极坐标方程为

$$r = a \sin 3\theta.$$

以上作法及结论, 由图很容易看出.



图 6·29

3380. 设 $x^2 + xy + y^2 = 3$,

求 y' , y'' 及 y''' .

解 等式两端对 x 求导数, 得

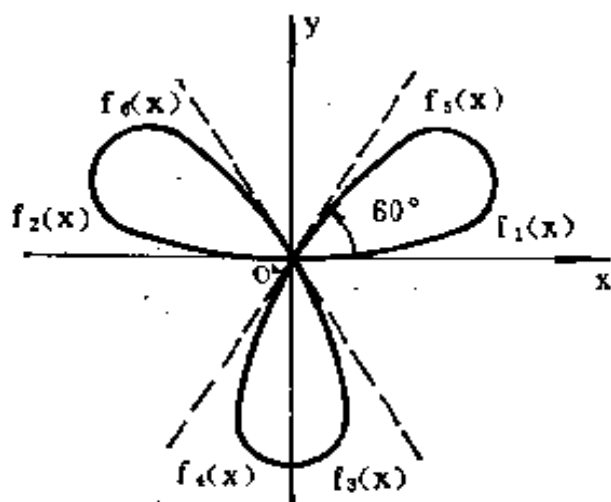
$$2x + y + xy' + 2yy' = 0.$$

于是,

$$y' = -\frac{2x + y}{x + 2y}.$$

再对上式求导数, 得

$$y'' = -\frac{1}{(x + 2y)^2} \left\{ (2 + y')(x + 2y) - (1 + 2y')(2x + y) \right\} = -\frac{18}{(x + 2y)^3};$$

$$y''' = \frac{54}{(x + 2y)^4} (1 + 2y') = -\frac{162x}{(x + 2y)^5}.$$

3381. 设:

$$x^2 - xy + 2y^2 + x - y - 1 = 0,$$

求 y' , y'' 及 y''' 当 $x = 0$, $y = 1$ 时的值.

解 等式两端对 x 求导数, 得

$$2x - y - xy' + 4yy' + 1 - y' = 0. \quad (1)$$

以 $x=0$, $y=1$ 代入(1)式, 得

$$y' \Big|_{\substack{x=0 \\ y=1}} = 0.$$

将(1)式再对 x 求导数, 得

$$2 - y' - y' - xy'' + 4y'^2 + 4yy'' - y'' = 0. \quad (2)$$

以 $x=0$, $y=1$, $y'=0$ 代入(2)式, 得

$$y'' \Big|_{\substack{x=0 \\ y=1}} = -\frac{2}{3}.$$

将(2)式再对 x 求导数, 得

$$-3y'' - xy''' + 12y'y'' + 4yy''' - y''' = 0. \quad (3)$$

以 $x=0$, $y=1$, $y'=0$, $y''=-\frac{2}{3}$ 代入(3)式, 得

$$y''' \Big|_{\substack{x=0 \\ y=1}} = -\frac{2}{3}.$$

3382. 证明: 对于二次曲线

$$ax^2 + 2bxy + cy^2 + 2dx + 2ey + f = 0,$$

等式

$$\frac{d^3}{dx^3} \left[(y'')^{-\frac{2}{3}} \right] = 0$$

为真.

证 原题中的二次曲线应是非退化的, 即

$$\Delta = \begin{vmatrix} a & b & d \\ b & c & e \\ d & e & f \end{vmatrix} \neq 0,$$

由 $\Delta \neq 0$ 保证 $y'' \neq 0$.

等式两端对 x 求导数, 得

$$2ax + 2by + 2bxy' + 2cyy' + 2d + 2ey' = 0. \quad (1)$$

于是,

$$y' = -\frac{ax + by + d}{bx + cy + e}.$$

(1) 式除以 2 后, 两端再对 x 求导数, 得

$$a + 2by' + cy'^2 + (bx + cy + e)y'' = 0.$$

于是,

$$\begin{aligned} y'' &= -\frac{a + 2by' + cy'^2}{bx + cy + e} = -\frac{1}{(bx + cy + e)^3} \\ &\quad \cdot \{a(bx + cy + e)^2 - 2b(bx + cy + e)(ax + by + d) \\ &\quad + c(ax + by + d)^2\} \\ &= \frac{\Delta}{(bx + cy + e)^3}, \\ (y'')^{-\frac{2}{3}} &= \Delta^{-\frac{2}{3}} \cdot (bx + cy + e)^2 \\ &= \Delta^{-\frac{2}{3}} \cdot [b^2x^2 + c(cy^2 + 2bxy + 2ey) + e^2 + 2bex] \\ &= \Delta^{-\frac{2}{3}} \cdot [b^2x^2 - c(ax^2 + 2dx + f) + 2bex + e^2] \\ &= \Delta^{-\frac{2}{3}} \cdot [(b^2 - ac)x^2 + 2(be - cd)x + e^2 - cf], \end{aligned}$$

即 $(y'')^{-\frac{2}{3}}$ 是关于 x 的二次三项式, 故

$$\frac{d^3}{dx^3} \left[(y'')^{-\frac{2}{3}} \right] = 0.$$

对于函数 $z = z(x, y)$ 求一阶和二阶的偏导函数, 设:

3383. $x^2 + y^2 + z^2 = a^2$.

解 等式两端微分, 得

$$2x dx + 2y dy + 2z dz = 0, \quad (1)$$

$$dx^2 + dy^2 + dz^2 + z d^2 z = 0, \quad (2)$$

由 (1) 得

$$dz = -\frac{x}{z} dx - \frac{y}{z} dy,$$

故有

$$\frac{\partial z}{\partial x} = -\frac{x}{z}, \quad \frac{\partial z}{\partial y} = -\frac{y}{z}.$$

由 (2) 得

$$\begin{aligned} d^2 z &= -\frac{1}{z}(dx^2 + dy^2 + dz^2) \\ &= -\frac{1}{z}dx^2 - \frac{1}{z}dy^2 - \frac{1}{z}\left(\frac{x}{z}dx + \frac{y}{z}dy\right)^2 \\ &= -\frac{1}{z}\left(1 + \frac{x^2}{z^2}\right)dx^2 - \frac{2xy}{z^3}dxdy - \frac{1}{z}\left(1 + \frac{y^2}{z^2}\right)dy^2, \end{aligned}$$

故有

$$\frac{\partial^2 z}{\partial x^2} = -\frac{1}{z}\left(1 + \frac{x^2}{z^2}\right) = -\frac{z^2 + x^2}{z^3},$$

$$\frac{\partial^2 z}{\partial x \partial y} = -\frac{xy}{z^3}, \quad \frac{\partial^2 z}{\partial y^2} = -\frac{z^2 + y^2}{z^3}.$$

3384. $z^3 - 3xyz = a^3$.

解 等式两端对 x 求偏导函数, 得

$$3z^2 \frac{\partial z}{\partial x} - 3yz - 3xy \frac{\partial z}{\partial x} = 0, \quad (1)$$

于是,

$$\frac{\partial z}{\partial x} = \frac{yz}{z^2 - xy}.$$

同法可得

$$\frac{\partial z}{\partial y} = \frac{xz}{z^2 - xy}.$$

(1) 式除以 3 后再分别对 x 及对 y 求偏导函数, 得

$$2z \left(\frac{\partial z}{\partial x} \right)^2 + z^2 \frac{\partial^2 z}{\partial x^2} - 2y \frac{\partial z}{\partial x} - xy \frac{\partial^2 z}{\partial x^2} = 0,$$

$$\left(2z \frac{\partial z}{\partial y} - x \right) \frac{\partial z}{\partial x} + (z^2 - xy) \frac{\partial^2 z}{\partial x \partial y}$$

$$- z - y \frac{\partial z}{\partial y} = 0.$$

将 $\frac{\partial z}{\partial x}$ 及 $\frac{\partial z}{\partial y}$ 代入上述两式, 化简整理得

$$\frac{\partial^2 z}{\partial x^2} = - \frac{2xy^3z}{(z^2 - xy)^3};$$

$$\frac{\partial^2 z}{\partial x \partial y} = \frac{z(z^4 - 2xyz^2 - x^2y^2)}{(z^2 - xy)^3}.$$

同法可得

$$\frac{\partial^2 z}{\partial y^2} = - \frac{2x^3yz}{(z^2 - xy)^3}.$$

3385. $x+y+z=e^z$.

解 等式两端微分, 得

$$dx+dy+dz=e^z dz, \quad (1)$$

故有

$$dz = \frac{1}{e^z-1}(dx+dy) = \frac{1}{x+y+z-1}(dx+dy).$$

于是,

$$\frac{\partial z}{\partial x} = \frac{\partial z}{\partial y} = \frac{1}{x+y+z-1}.$$

再将 (1) 式微分一次, 得

$$d^2z = e^z d^2z + e^z dz^2,$$

故有

$$d^2z = -\frac{e^z}{e^z-1}(dz)^2 = -\frac{e^z}{(e^z-1)^3}(dx^2 + 2dxdy + dy^2).$$

于是,

$$\begin{aligned} \frac{\partial^2 z}{\partial x^2} &= \frac{\partial^2 z}{\partial x \partial y} = \frac{\partial^2 z}{\partial y^2} = -\frac{e^z}{(e^z-1)^3} \\ &= -\frac{x+y+z}{(x+y+z-1)^3}. \end{aligned}$$

3386. $z = \sqrt{x^2-y^2} \operatorname{tg} \frac{z}{\sqrt{x^2-y^2}}$.

解 设 $r = \sqrt{x^2-y^2}$, 则 $\frac{z}{r} = \operatorname{tg} \frac{z}{r}$,

$$d\left(\frac{z}{r}\right) = \frac{d\left(\frac{z}{r}\right)}{1 + \left(\frac{z}{r}\right)^2}.$$

从而有 $d\left(\frac{z}{r}\right) = 0$, 或 $rdz - zdr = 0$, 即

$$dz = \frac{z}{r^2}(xdx - ydy). \quad (1)$$

于是,

$$\frac{\partial z}{\partial x} = \frac{zx}{r^2} = \frac{xz}{x^2 - y^2}, \quad \frac{\partial z}{\partial y} = -\frac{yz}{r^2} = -\frac{yz}{x^2 - y^2}.$$

由 (1) 得

$$(x^2 - y^2)dz = xzdx - yzdy. \quad (2)$$

(2) 式再微分一次, 得

$$\begin{aligned} (x^2 - y^2)d^2z &= -(2xdx - 2ydy)dz + xdx dz \\ &\quad + zdx^2 - ydy dz - zdy^2 \\ &= -(xdx - ydy) \left[\frac{z(xdx - ydy)}{x^2 - y^2} \right] + zdx^2 - zdy^2 \\ &= \frac{z}{x^2 - y^2} \left[-x^2 dx^2 + 2xy dx dy - y^2 dy^2 \right. \\ &\quad \left. + (x^2 - y^2) dx^2 - (x^2 - y^2) dy^2 \right] \\ &= \frac{z(-y^2 dx^2 + 2xy dx dy - x^2 dy^2)}{x^2 - y^2}. \end{aligned}$$

于是,

$$\frac{\partial^2 z}{\partial x^2} = -\frac{y^2 z}{(x^2 - y^2)^2}, \quad \frac{\partial^2 z}{\partial x \partial y} = \frac{xyz}{(x^2 - y^2)^2},$$

$$\frac{\partial^2 z}{\partial y^2} = -\frac{x^2 z}{(x^2 - y^2)^2}.$$

3387. $x + y + z = e^{-(x+y+z)}$.

解: 等式两端对 x 求偏导函数, 得

$$1 + \frac{\partial z}{\partial x} = e^{-(x+y+z)} \cdot \left(-1 - \frac{\partial z}{\partial x}\right).$$

于是,

$$\frac{\partial z}{\partial x} = -1.$$

利用对称性, 得

$$\frac{\partial z}{\partial y} = -1.$$

显见

$$\frac{\partial^2 z}{\partial x^2} = \frac{\partial^2 z}{\partial x \partial y} = \frac{\partial^2 z}{\partial y^2} = 0.$$

3388. 设:

$$x^2 + y^2 + z^2 - 3xyz = 0 \quad (1)$$

及

$$f(x, y, z) = xy^2z^3.$$

求: (a) $f'_x(1, 1, 1)$, 设 $z = z(x, y)$ 是由方程 (1) 所定义的隐函数, (b) $f'_x(1, 1, 1)$, 设 $y = y(x, z)$ 是由方程 (1) 所定义的隐函数. 说明为什么这些导

函数相异.

解 (a) 记 $F(x, y, z) = x^2 + y^2 + z^2 - 3xyz = 0$,
则由方程 (1) 所定义的隐函数 $z = z(x, y)$ 的偏导
函数 $z'_x(x, y)$ 在 $(1, 1)$ 点的值为

$$\begin{aligned} z'_x(1, 1) &= -\frac{F'_x(1, 1, 1)}{F'_z(1, 1, 1)} = -\frac{\left. \frac{d}{dx} F(x, 1, 1) \right|_{x=1}}{\left. \frac{d}{dz} F(1, 1, z) \right|_{z=1}} \\ &= -\frac{\left. \frac{d}{dx} (x^2 + 2 - 3x) \right|_{x=1}}{\left. \frac{d}{dz} (2 + z^2 - 3z) \right|_{z=1}} = -1. \end{aligned}$$

于是,

$$\begin{aligned} &\left. \frac{\partial}{\partial x} [f(x, y, z(x, y))] \right|_{(1, 1, 1)} \\ &= \left. \frac{d}{dx} f(x, 1, 1) \right|_{x=1} + \left. \frac{\partial}{\partial z} f(1, 1, z) \right|_{z=1} \cdot z'_x(1, 1) \\ &= 1 + 3 \cdot (-1) = -2. \end{aligned}$$

$$\begin{aligned} (b) \quad y'_x(1, 1) &= -\frac{F'_x(1, 1, 1)}{F'_y(1, 1, 1)} \\ &= -\frac{\left. \frac{d}{dx} F(x, 1, 1) \right|_{x=1}}{\left. \frac{d}{dy} F(1, y, 1) \right|_{y=1}} = -1. \end{aligned}$$

于是,

$$\left. \frac{\partial}{\partial x} [f(x, y(x, z), z)] \right|_{(1, 1, 1)}$$

$$\begin{aligned}
&= \frac{d}{dx} f(x, 1, 1) \Big|_{x=1} + \frac{d}{dy} f(1, y, 1) \Big|_{y=1} \cdot y'_x(1, 1) \\
&= 1 + 2 \cdot (-1) = -1.
\end{aligned}$$

由 (a) 与 (b) 所求得的对 x 的偏导函数在 $(1, 1, 1)$ 点的值不相等, 可说明如下:

方程 $F(x, y, z) = 0$ 代表一个空间曲面, 而 $f(x, y, z)$ 表示定义在这个曲面上的一个函数. 函数 $G(x, y) = f(x, y, z(x, y))$ 表示把原曲面上的点投影到 Oxy 平面上后, 原曲面上的函数看成在 Oxy 平面上定义的一个函数, $G'_x(x, y)$ 表示此函数在 Ox 轴方向的变化率, 它不仅包含了原来函数在 Ox 轴方向的变化率, 还包含了原来函数在 Oz 轴方向的变化率的一部份. 同样地, $H(x, z) = f(x, y(x, z), z)$ 表示把原曲面上的点投影到 Oxz 平面上后, 原曲面上的函数看成在 Oxz 平面上定义的函数, $H'_x(x, z)$ 表示此函数在 Ox 轴方向的变化率, 它不仅包含了原来函数在 Ox 轴方向的变化率, 还包含了原来函数在 Oy 轴方向的变化率的一部份. 一般地, 原来函数在 Oy 轴和 Oz 轴方向的变化率的那两部份是不相等的.

3389. 设 $x^2 + 2y^2 + 3z^2 + xy - z - 9 = 0$, 求 $\frac{\partial^2 z}{\partial x^2}$, $\frac{\partial^2 z}{\partial x \partial y}$,

$\frac{\partial^2 z}{\partial y^2}$ 当 $x = 1$, $y = -2$, $z = 1$ 时的值.

解 等式两端微分一次, 得

$$2x dx + 4y dy + 6z dz + x dy + y dx - dz = 0.$$

即

$$(1-6z)dz=(2x+y)dx+(4y+x)dy. \quad (1)$$

再微分一次, 得

$$(1-6z)d^2z=6dz^2+2dx^2+2dxdy+4dy^2. \quad (2)$$

以 $x=1, y=-2, z=1$ 代入 (1) 式, 得 $dz=\frac{7}{5}dy$.

再以 $z=1, dz=\frac{7}{5}dy$ 代入 (2) 式, 得

$$d^2z=-\frac{2}{5}dx^2-\frac{2}{5}dxdy-\frac{394}{125}dy^2.$$

于是, 当 $x=1, y=-2, z=1$ 时,

$$\frac{\partial^2 z}{\partial x^2}=-\frac{2}{5}, \quad \frac{\partial^2 z}{\partial x \partial y}=-\frac{1}{5}, \quad \frac{\partial^2 z}{\partial y^2}=-\frac{394}{125}.$$

求 dz 和 d^2z , 设:

$$3390. \quad \frac{x^2}{a^2} + \frac{y^2}{b^2} + \frac{z^2}{c^2} = 1.$$

解 等式两端微分一次, 得

$$\frac{2x}{a^2}dx + \frac{2y}{b^2}dy + \frac{2z}{c^2}dz = 0.$$

于是,

$$dz = -\frac{c^2}{z} \left(\frac{xdx}{a^2} + \frac{ydy}{b^2} \right).$$

再将 dz 微分一次, 得

$$d^2z = -\frac{c^2}{z^2} \left[z \left(\frac{dx^2}{a^2} + \frac{dy^2}{b^2} \right) - \left(\frac{xdx}{a^2} + \frac{ydy}{b^2} \right) dz \right]$$

$$= -\frac{c^4}{z^3} \left[\left(\frac{x^2}{a^2} + \frac{z^2}{c^2} \right) \frac{dx^2}{a^2} + \frac{2xy}{a^2 b^2} dx dy + \left(\frac{y^2}{b^2} + \frac{z^2}{c^2} \right) \frac{dy^2}{b^2} \right].$$

3391. $xyz = x + y + z$.

解 等式两端微分一次, 得

$$yz dx + xz dy + xy dz = dx + dy + dz. \quad (1)$$

于是,

$$dz = -\frac{(1-yz)dx + (1-xz)dy}{1-xy}. \quad (2)$$

对 (1) 式再微分一次, 得

$$2z dx dy + 2x dy dz + 2y dx dz + xy d^2 z = d^2 z. \quad (3)$$

以 (2) 式代入 (3) 式, 化简整理得

$$\begin{aligned} d^2 z &= -\frac{2}{(1-xy)^2} \left\{ y(1-yz) dx^2 + [x+y \right. \\ &\quad \left. - z(1+xy)] dx dy + x(1-xz) dy^2 \right\} \\ &= -\frac{2 \{ y(1-yz) dx^2 - 2z dx dy + x(1-xz) dy^2 \}}{(1-xy)^2}. \end{aligned}$$

3392. $\frac{x}{z} = \ln \frac{z}{y}$.

解 等式两端微分一次, 得

$$\frac{z dx - x dz}{z^2} = \frac{dz}{z} - \frac{dy}{y}.$$

于是,

$$dz = \frac{z(ydx + zdy)}{y(x+z)}.$$

对 $(x+z)dz = zdx + \frac{z^2}{y}dy$ 再微分一次, 得

$$\begin{aligned} (x+z)d^2z &= -(dx+dz)dz + dzdx \\ &\quad + \frac{2z}{y}dzdy - \frac{z^2}{y^2}dy^2 \\ &= -dz^2 + \frac{2z}{y}dydz - \frac{z^2}{y^2}dy^2 = -\left(dz - \frac{z}{y}dy\right)^2 \\ &= -\frac{z^2[(ydx + zdy) - (x+z)dy]^2}{y^2(x+z)^2} \\ &= -\frac{z^2(ydx - xdy)}{y^2(x+z)^2}. \end{aligned}$$

于是,

$$d^2z = -\frac{z^2(ydx - xdy)^2}{y^2(x+z)^3}.$$

3393. $z = x + \operatorname{arc} \operatorname{tg} \frac{y}{z-x}.$

解 等式两端微分一次, 得

$$dz = dx + \frac{1}{1 + \frac{y^2}{(z-x)^2}} \cdot \frac{(z-x)dy - y(dz - dx)}{(z-x)^2}.$$

化简整理, 得

$$dz = dx + \frac{z-x}{(z-x)^2 + y(y+1)} dy.$$

再对上式微分一次，得

$$d^2z = \frac{1}{[(z-x)^2 + y(y+1)]^2} \{ [(z-x)^2 + y(y+1)] dy \cdot (dz - dx) - (z-x) dy \cdot [2(z-x)(dz - dx) + 2y dy + dy] \}.$$

将 dz 代入化简整理，即有

$$d^2z = \frac{2(x-z)(y+1)[(x-z)^2 + y^2]}{[(x-z)^2 + y(y+1)]^3} dy^2.$$

3394. 设 $u^3 - 3(x+y)u^2 + z^3 = 0$ ，求 du 。

解 等式两端微分，得

$$3u^2 du - 3u^2(dx + dy) - 6u(x+y)du + 3z^2 dz = 0.$$

于是，

$$du = \frac{u^2(dx + dy) - z^2 dz}{u[u - 2(x+y)]}.$$

3395. 设 $F(x+y+z, x^2+y^2+z^2) = 0$ ，求 $\frac{\partial^2 z}{\partial x \partial y}$ 。

解 等式两端对 x 求偏导函数，得

$$F'_1 \cdot \left(1 + \frac{\partial z}{\partial x}\right) + F'_2 \cdot \left(2x + 2z \frac{\partial z}{\partial x}\right) = 0.$$

于是，

$$\frac{\partial z}{\partial x} = -\frac{F'_1 + 2xF'_2}{F'_1 + 2zF'_2}. \quad (1)$$

同法可得

$$\frac{\partial z}{\partial y} = -\frac{F'_1 + 2yF'_2}{F'_1 + 2zF'_2}.$$

(1) 式两端对 y 求偏导函数, 得

$$\begin{aligned} \frac{\partial^2 z}{\partial x \partial y} &= -\frac{1}{(F'_1 + 2zF'_2)^2} \{ (F'_1 + 2zF'_2) \\ &\cdot [(F'_1)'_y + 2x(F'_2)'_y] - (F'_1 + 2x(F'_2)) \\ &\cdot [(F'_1)'_y + 2z(F'_2)'_y + 2z'_y \cdot F'_2] \} \\ &= -\frac{1}{(F'_1 + 2zF'_2)^2} \{ 2(x-z)F'_1 \cdot (F'_2)'_y + 2(z-x)F'_2 \\ &\cdot (F'_1)'_y - 2[F'_1F'_2 + x(F'_2)^2]z'_y \} \\ &= -\frac{2(x-z)}{(F'_1 + 2zF'_2)^2} \{ F'_1 \cdot (F'_2)'_y - F'_2 \cdot (F'_1)'_y \} \\ &\quad - \frac{2F'_2 \cdot (F'_1 + 2x(F'_2)) \cdot (F'_1 + 2yF'_2)}{(F'_1 + 2zF'_2)^3}. \end{aligned}$$

现分别求 $(F'_1)'_y$ 及 $(F'_2)'_y$:

$$(F'_1)'_y = F''_{11} \cdot (1 + z'_y) + F''_{12} \cdot (2y + 2zz'_y),$$

$$(F'_2)'_y = F''_{21} \cdot (1 + z'_y) + F''_{22} \cdot (2y + 2zz'_y).$$

注意到

$$1 + z'_y = \frac{2(z-y)F'_2}{F'_1 + 2zF'_2}, \quad 2y + 2zz'_y = \frac{2(y-z)F'_1}{F'_1 + 2zF'_2},$$

即得

$$F'_1 \cdot (F'_2)'_y - F'_2 \cdot (F'_1)'_y = F'_1 F''_{21} \cdot \frac{2(z-y)F'_2}{F'_1 + 2zF'_2}$$

$$\begin{aligned}
& + F'_1 F''_{22} \cdot \frac{2(y-z)F'_1}{F'_1 + 2zF'_2} \\
& - F'_2 F''_{11} \cdot \frac{2(z-y)F'_2}{F'_1 + 2zF'_2} - F'_2 F''_{12} \cdot \frac{2(y-z)F'_1}{F'_1 + 2zF'_2} \\
& = \frac{2(y-z)}{F'_1 + 2zF'_2} \{ (F'_1)^2 F''_{22} - 2F'_1 F'_2 F''_{12} + (F'_2)^2 F''_{11} \}.
\end{aligned}$$

于是,

$$\begin{aligned}
\frac{\partial^2 z}{\partial x \partial y} & = - \frac{4(x-z)(y-z)}{(F'_1 + 2zF'_2)^3} \{ (F'_1)^2 F''_{22} \\
& - 2F'_1 F'_2 F''_{12} + (F'_2)^2 F''_{11} \} \\
& - \frac{2F'_2 \cdot (F'_1 + 2xF'_2) \cdot (F'_1 + 2yF'_2)}{(F'_1 + 2zF'_2)^3}.
\end{aligned}$$

3396. 设 $F(x-y, y-z, z-x) = 0$, 求 $\frac{\partial z}{\partial x}$ 和 $\frac{\partial z}{\partial y}$.

解 等式两端对 x 求偏导函数, 得

$$F'_1 + F'_2 \cdot \left(-\frac{\partial z}{\partial x}\right) + F'_3 \cdot \left(\frac{\partial z}{\partial x} - 1\right) = 0.$$

于是,

$$\frac{\partial z}{\partial x} = \frac{F'_1 - F'_3}{F'_2 - F'_3}.$$

同法可得

$$\frac{\partial z}{\partial y} = \frac{F'_2 - F'_1}{F'_2 - F'_3}.$$

3397. 设 $F(x, x+y, x+y+z)=0$, 求 $\frac{\partial z}{\partial x}$, $\frac{\partial z}{\partial y}$ 和 $\frac{\partial^2 z}{\partial x^2}$.

解 等式两端分别对 x 及对 y 求偏导函数, 得

$$F'_1 + F'_2 + F'_3 \cdot \left(1 + \frac{\partial z}{\partial x}\right) = 0,$$

$$F'_2 + F'_3 \cdot \left(1 + \frac{\partial z}{\partial y}\right) = 0.$$

于是,

$$\frac{\partial z}{\partial x} = -\left(1 + \frac{F'_1 + F'_2}{F'_3}\right), \quad \frac{\partial z}{\partial y} = -\left(1 + \frac{F'_2}{F'_3}\right).$$

再将 $\frac{\partial z}{\partial x}$ 对 x 求偏导函数, 得

$$\begin{aligned} \frac{\partial^2 z}{\partial x^2} = & -\frac{1}{(F'_3)^2} \left\{ F'_3 \cdot \left[F''_{11} + F''_{12} + F''_{13} \cdot \left(1 + \frac{\partial z}{\partial x}\right) \right. \right. \\ & \left. \left. + F''_{21} + F''_{22} + F''_{23} \cdot \left(1 + \frac{\partial z}{\partial x}\right) \right] \right. \\ & \left. - (F'_1 + F'_2) \cdot \left[F''_{31} + F''_{32} + F''_{33} \cdot \left(1 + \frac{\partial z}{\partial x}\right) \right] \right\}. \end{aligned}$$

将 $\frac{\partial z}{\partial x}$ 代入化简整理得

$$\begin{aligned} \frac{\partial^2 z}{\partial x^2} = & -\frac{1}{(F'_3)^3} \left\{ (F'_3)^2 \cdot (F''_{11} + 2F''_{12} + F''_{22}) \right. \\ & \left. - 2(F'_1 + F'_2)F'_3 \cdot (F''_{13} + F''_{23}) + (F'_1 + F'_2)^2 F''_{33} \right\}. \end{aligned}$$

3398. 设 $F(xz, yz)=0$, 求 $\frac{\partial^2 z}{\partial x^2}$.

解 等式两端对 x 求偏导函数, 得

$$F'_1 \cdot \left(z + x \frac{\partial z}{\partial x} \right) + F'_2 \cdot y \frac{\partial z}{\partial x} = 0.$$

于是,

$$\frac{\partial z}{\partial x} = - \frac{z F'_1}{x F'_1 + y F'_2}.$$

将 $\frac{\partial z}{\partial x}$ 再对 x 求偏导函数, 得

$$\begin{aligned} \frac{\partial^2 z}{\partial x^2} = & - \frac{1}{(x F'_1 + y F'_2)^2} \left\{ (x F'_1 + y F'_2) \cdot \left[F'_1 \frac{\partial z}{\partial x} \right. \right. \\ & \left. \left. + z \left(F''_{11} \cdot \left(z + x \frac{\partial z}{\partial x} \right) + F''_{12} y \frac{\partial z}{\partial x} \right) \right] \right. \\ & - \left[F'_1 + x \left(F''_{11} \cdot \left(z + x \frac{\partial z}{\partial x} \right) + F''_{12} y \frac{\partial z}{\partial x} \right) \right. \\ & \left. \left. + y \left(F''_{21} \cdot \left(z + x \frac{\partial z}{\partial x} \right) + F''_{22} y \frac{\partial z}{\partial x} \right) \right] z F'_1 \right\}. \end{aligned}$$

将 $\frac{\partial z}{\partial x}$ 代入化简整理得

$$\begin{aligned} \frac{\partial^2 z}{\partial x^2} = & - \frac{1}{(x F'_1 + y F'_2)^3} \left\{ y^2 z^2 [(F'_1)^2 F''_{22} \right. \\ & \left. - 2 F'_1 F'_2 F''_{12} + (F'_2)^2 F''_{11}] - 2z (F'_1)^2 \right. \\ & \left. \cdot (x F'_1 + y F'_2) \right\}. \end{aligned}$$

3399. 设 (a) $F(x+z, y+z)=0$;

(b) $F\left(\frac{x}{z}, \frac{y}{z}\right)=0$, 求 $d^2 z$.

解 (a) 等式两端微分, 得

$$F'_1 \cdot (dx + dz) + F'_2 \cdot (dy + dz) = 0. \quad (1)$$

于是,

$$dz = -\frac{F'_1 dx + F'_2 dy}{F'_1 + F'_2},$$

$$dx + dz = \frac{F'_2 \cdot (dx - dy)}{F'_1 + F'_2},$$

$$dy + dz = -\frac{F'_1 \cdot (dx - dy)}{F'_1 + F'_2}.$$

对 (1) 式再求一次微分, 得

$$F''_{11} \cdot (dx + dz)^2 + 2F''_{12} \cdot (dx + dz)(dy + dz) \\ + F''_{22} \cdot (dy + dz)^2 + (F'_1 + F'_2)d^2z = 0.$$

于是,

$$d^2z = -\frac{1}{F'_1 + F'_2} [F''_{11} \cdot (dx + dz)^2 + 2F''_{12} \\ \cdot (dx + dz)(dy + dz) + F''_{22} \cdot (dy + dz)^2] \\ = -\frac{1}{(F'_1 + F'_2)^2} [F''_{11} \cdot (F'_2)^2 - 2F'_1 F'_2 F''_{12} \\ + F''_{22} \cdot (F'_1)^2] (dx - dy)^2.$$

(6) 等式两端微分, 得

$$F'_1 \cdot \frac{zdx - xdz}{z^2} + F'_2 \cdot \frac{zdy - ydz}{z^2} = 0. \quad (2)$$

于是,

$$dz = \frac{z(F'_1 dx + F'_2 dy)}{xF'_1 + yF'_2},$$

$$zdx - xdz = \frac{zF'_2 \cdot (ydx - xdy)}{xF'_1 + yF'_2},$$

$$zdy - ydz = -\frac{zF'_1 \cdot (ydx - xdy)}{xF'_1 + yF'_2}.$$

(2) 式乘以 z^2 后再微分一次, 得

$$F''_{11} \cdot \frac{(zdx - xdz)^2}{z^2} + 2F''_{12}$$

$$\cdot \frac{(zdx - xdz)(zdy - ydz)}{z^2} + F''_{22} \cdot \frac{(zdy - ydz)^2}{z^2}$$

$$- (xF'_1 + yF'_2) d^2z = 0.$$

于是,

$$d^2z = \frac{1}{z^2(xF'_1 + yF'_2)} [F''_{11} \cdot (zdx - xdz)^2$$

$$+ 2F''_{12}(zdx - xdz)(zdy - ydz)$$

$$+ F''_{22} \cdot (zdy - ydz)^2]$$

$$= \frac{(ydx - xdy)^2}{(xF'_1 + yF'_2)^3} [F''_{11} \cdot (F'_2)^2$$

$$- 2F'_1 F'_2 F''_{12} + F''_{22} \cdot (F'_1)^2].$$

3400. 设 $x = x(y, z)$, $y = y(x, z)$, $z = z(x, y)$ 为由方程 $F(x, y, z) = 0$ 所定义的函数. 证明:

$$\frac{\partial x}{\partial y} \cdot \frac{\partial y}{\partial z} \cdot \frac{\partial z}{\partial x} = -1.$$

证 根据隐函数求导法, 有

$$\frac{\partial x}{\partial y} = -\frac{\frac{\partial F}{\partial y}}{\frac{\partial F}{\partial x}}, \quad \frac{\partial y}{\partial z} = -\frac{\frac{\partial F}{\partial z}}{\frac{\partial F}{\partial y}}, \quad \frac{\partial z}{\partial x} = -\frac{\frac{\partial F}{\partial x}}{\frac{\partial F}{\partial z}}.$$

三式相乘即得

$$\frac{\partial x}{\partial y} \cdot \frac{\partial y}{\partial z} \cdot \frac{\partial z}{\partial x} = -1.$$

3401. 设 $x+y+z=0$, $x^2+y^2+z^2=1$, 求 $\frac{dx}{dz}$ 和 $\frac{dy}{dz}$.

解 对 z 求导数, 得

$$\begin{cases} \frac{dx}{dz} + \frac{dy}{dz} + 1 = 0, \\ 2x \frac{dx}{dz} + 2y \frac{dy}{dz} + 2z = 0. \end{cases}$$

联立求解, 得

$$\frac{dx}{dz} = \frac{y-z}{x-y}, \quad \frac{dy}{dz} = \frac{z-x}{x-y}.$$

3402. 设 $x^2+y^2=\frac{1}{2}z^2$, $x+y+z=2$, 求 $\frac{dx}{dz}$, $\frac{dy}{dz}$, $\frac{d^2x}{dz^2}$

和 $\frac{d^2y}{dz^2}$ 当 $x=1$, $y=-1$, $z=2$ 时的值.

解 对 z 求导数, 得

$$\begin{cases} 2x \frac{dx}{dz} + 2y \frac{dy}{dz} = z, & (1) \end{cases}$$

$$\begin{cases} \frac{dx}{dz} + \frac{dy}{dz} + 1 = 0, & (2) \end{cases}$$

$$\begin{cases} 2\left(\frac{dx}{dz}\right)^2 + 2x\frac{d^2x}{dz^2} + 2\left(\frac{dy}{dz}\right)^2 + 2\frac{d^2y}{dz^2} = 1, & (3) \\ \frac{d^2x}{dz^2} + \frac{d^2y}{dz^2} = 0, & (4) \end{cases}$$

將 $x=1, y=-1, z=2$ 代入 (1), (2), 解得

$$\frac{dx}{dz} = 0, \quad \frac{dy}{dz} = -1.$$

將上述結果及 x, y, z 值聯同由 (4) 式所決定的式子

$\frac{d^2x}{dz^2} = -\frac{d^2y}{dz^2}$ 一起代入 (3) 式, 即得

$$\frac{d^2x}{dz^2} = -\frac{1}{4}, \quad \frac{d^2y}{dz^2} = \frac{1}{4}.$$

3403. 設 $xu - yv = 0, yu + xv = 1$, 求 $\frac{\partial u}{\partial x}, \frac{\partial u}{\partial y}, \frac{\partial v}{\partial x}$ 和

$$\frac{\partial v}{\partial y}.$$

解 微分得

$$\begin{cases} xdu - ydv = vdy - udx, \\ ydu + xdv = -vdx - udy. \end{cases}$$

於是,

$$du = \frac{1}{x^2 + y^2} [-(xu + yv)dx + (xv - yu)dy],$$

$$\frac{\partial u}{\partial x} = -\frac{xu + yv}{x^2 + y^2}, \quad \frac{\partial u}{\partial y} = \frac{xv - yu}{x^2 + y^2}.$$

同法可得

$$\frac{\partial v}{\partial x} = \frac{yu - xv}{x^2 + y^2}, \quad \frac{\partial v}{\partial y} = -\frac{xu + yv}{x^2 + y^2} \quad (x^2 + y^2 > 0).$$

3404. 设 $u + v = x + y$, $\frac{\sin u}{\sin v} = \frac{x}{y}$, 求 du, dv, d^2u 和 d^2v .

解 将原式改写为

$$\begin{cases} u + v = x + y, \\ y \sin u = x \sin v. \end{cases}$$

微分得

$$\begin{cases} du + dv = dx + dy, & (1) \end{cases}$$

$$\begin{cases} \sin u dy + y \cos u du = \sin v dx + x \cos v dv. & (2) \end{cases}$$

联立求解, 得

$$du = \frac{1}{x \cos v + y \cos u} [(\sin v + x \cos v) dx - (\sin u - x \cos v) dy],$$

$$dv = \frac{1}{x \cos v + y \cos u} [-(\sin v - y \cos u) dx + (\sin u + y \cos u) dy].$$

对 (1), (2) 式再微分一次, 得

$$\begin{cases} d^2u + d^2v = 0, \\ y \cos u \cdot d^2u + 2 \cos u \cdot dy du - y \sin u \cdot du^2 \\ = x \cos v \cdot d^2v + 2 \cos v \cdot dx dv - x \sin v \cdot dv^2. \end{cases}$$

联立求解, 得

$$d^2u = -d^2v = \frac{1}{x \cos v + y \cos u} [(2 \cos v dx - x \sin v dv) dv - (2 \cos u dy - y \sin u du) du].$$

3405. 设:

$$e^{\frac{x}{y}} \cos \frac{v}{y} = \frac{x}{\sqrt{2}}, e^{\frac{x}{y}} \sin \frac{v}{y} = \frac{y}{\sqrt{2}}.$$

求 du, dv, d^2u 和 d^2v 当 $x=1, y=1, u=0, v=\frac{\pi}{4}$ 时的表达式.

解 将所给二式相除及平方相加, 分别得

$$\begin{cases} \operatorname{tg} \frac{v}{y} = \frac{y}{x}, & (1) \end{cases}$$

$$\begin{cases} e^{\frac{2x}{y}} = \frac{x^2 + y^2}{2}. & (2) \end{cases}$$

微分 (1) 式:

$$\sec^2 \frac{v}{y} \cdot \frac{y dv - v dy}{y^2} = \frac{x dy - y dx}{x^2}. \quad (3)$$

以 $x=1, y=1, v=\frac{\pi}{4}$ 代入 (3) 代, 得

$$dv = \frac{\pi}{4} dy - \frac{1}{2} (dx - dy).$$

微分 (3) 式:

$$2 \sec^2 \frac{v}{y} \operatorname{tg} \frac{v}{y} \cdot \left(\frac{y dv - v dy}{y^2} \right)^2 + \sec^2 \frac{v}{y}$$

$$\begin{aligned} & \frac{y^2 d^2 v - 2(y dv - v dy) dy}{y^3} \\ &= \frac{-2(x dy - y dx) dx}{x^3}. \end{aligned} \quad (4)$$

以 $x=1$, $y=1$, $v=\frac{\pi}{4}$ 及 dv 值代入 (4) 式, 得

$$d^2 v = \frac{1}{2} (dx - dy)^2.$$

微分 (2) 式:

$$2e^{\frac{2x}{y}} \cdot \frac{x du - u dx}{x^2} = x dx + y dy. \quad (5)$$

以 $x=1$, $y=1$, $u=0$ 代入 (5) 式, 得

$$du = \frac{dx + dy}{2}.$$

微分 (5) 式:

$$\begin{aligned} & 4e^{\frac{2x}{y}} \left(\frac{x du - u dx}{x^2} \right)^2 + 2e^{\frac{2x}{y}} \frac{x^2 d^2 u - 2(x du - u dx) dx}{x^3} \\ &= dx^2 + dy^2. \end{aligned} \quad (6)$$

以 $x=1$, $y=1$, $u=0$ 及 du 代入 (6) 式, 得

$$d^2 u = dx^2.$$

3406. 设:

$$x = t + t^{-1}, \quad y = t^2 + t^{-2}, \quad z = t^3 + t^{-3}.$$

求 $\frac{dy}{dx}$, $\frac{dz}{dx}$, $\frac{d^2 y}{dx^2}$ 和 $\frac{d^2 z}{dx^2}$.

$$\text{解} \quad \frac{dy}{dx} = \frac{\frac{dy}{dt}}{\frac{dx}{dt}} = \frac{2t - \frac{2}{t^3}}{1 - \frac{1}{t^2}} = 2 \left(t + \frac{1}{t} \right);$$

$$\frac{dz}{dx} = \frac{\frac{dz}{dt}}{\frac{dx}{dt}} = \frac{3t^2 - \frac{3}{t^4}}{1 - \frac{1}{t^2}} = 3 \left(t^2 + \frac{1}{t^2} + 1 \right);$$

$$\frac{d^2y}{dx^2} = \frac{\frac{d}{dt} \left(\frac{dy}{dx} \right)}{\frac{dx}{dt}} = \frac{2 \left(1 - \frac{1}{t^2} \right)}{1 - \frac{1}{t^2}} = 2;$$

$$\frac{d^2z}{dx^2} = \frac{\frac{d}{dt} \left(\frac{dz}{dx} \right)}{\frac{dx}{dt}} = \frac{3 \left(2t - \frac{2}{t^3} \right)}{1 - \frac{1}{t^2}} = 6 \left(t + \frac{1}{t} \right).$$

注 本题也可消去 t 以求 $\frac{dy}{dx}$, $\frac{dz}{dx}$, $\frac{d^2y}{dx^2}$ 和 $\frac{d^2z}{dx^2}$. 事实上,

$$y = \left(t + \frac{1}{t} \right)^2 - 2 = x^2 - 2,$$

$$z = \left(t + \frac{1}{t} \right) \left(t^2 - 1 + \frac{1}{t^2} \right) = x(x^2 - 3) = x^3 - 3x.$$

于是,

$$\frac{dy}{dx} = 2x, \quad \frac{dz}{dx} = 3x^2 - 3,$$

$$\frac{d^2y}{dx^2} = 2, \quad \frac{d^2z}{dx^2} = 6x.$$

再将 $x = t + \frac{1}{t}$ 代入上述结果, 即得

$$\frac{dy}{dx} = 2 \left(t + \frac{1}{t} \right), \quad \frac{dz}{dx} = 3 \left(t^2 + \frac{1}{t^2} + 1 \right),$$

$$\frac{d^2y}{dx^2} = 2, \quad \frac{d^2z}{dx^2} = 6 \left(t + \frac{1}{t} \right).$$

3407. 在 Oxy 平面上怎样的域内方程组

$$x = u + v, \quad y = u^2 + v^2, \quad z = u^3 + v^3$$

(式中参数 u 和 v 取一切可能的实数值) 定义 z 为变

数 x 和 y 的函数? 求导函数 $\frac{\partial z}{\partial x}$ 和 $\frac{\partial z}{\partial y}$.

解 由 $u + v = x$, $u^2 + v^2 = y$ 解得

$$u = \frac{x \pm \sqrt{2y - x^2}}{2}, \quad v = \frac{x \mp \sqrt{2y - x^2}}{2},$$

其中 $2y - x^2 \geq 0$ 或 $y \geq \frac{x^2}{2}$, 此即所求之域.

再由 $x = u + v$ 及 $y = u^2 + v^2$ 分别对 x 求偏导函数, 得

$$1 = \frac{\partial u}{\partial x} + \frac{\partial v}{\partial x}, \quad 0 = 2u \frac{\partial u}{\partial x} + 2v \frac{\partial v}{\partial x}.$$

联立求解得

$$\frac{\partial u}{\partial x} = \frac{v}{v - u}, \quad \frac{\partial v}{\partial x} = -\frac{u}{v - u} \quad (u \neq v).$$

又由 $z = u^3 + v^3$ 对 x 求偏导函数, 即可得

$$\frac{\partial z}{\partial x} = 3u^2 \frac{\partial u}{\partial x} + 3v^2 \frac{\partial v}{\partial x} = 3u^2 \cdot \frac{v}{v-u} - 3v^2 \cdot \frac{u}{v-u} = -3uv.$$

同法求得

$$\frac{\partial z}{\partial y} = \frac{3}{2}(u+v).$$

注 本题也可消去 u, v 求 $\frac{\partial z}{\partial x}$ 及 $\frac{\partial z}{\partial y}$. 事实上,

$$x^2 - y = 2uv,$$

$$z = (u+v)(u^2 - uv + v^2) = x \left(\frac{3}{2}y - \frac{x^2}{2} \right)$$

$$= \frac{x}{2}(3y - x^2).$$

于是,

$$\frac{\partial z}{\partial x} = \frac{3}{2}y - \frac{3}{2}x^2 = -3uv,$$

$$\frac{\partial z}{\partial y} = \frac{3}{2}x = \frac{3}{2}(u+v).$$

但一般说来, 用参数表示的函数和消去参数后的函数, 它们的定义域是不同的.

3408. 设 $x = \cos\varphi \cos\psi, y = \cos\varphi \sin\psi, z = \sin\varphi$, 求 $\frac{\partial^2 z}{\partial x^2}$.

解 由 $x = \cos\varphi \cos\psi, y = \cos\varphi \sin\psi$ 对 x 求偏导函数, 得

$$\begin{cases} 1 = -\sin\varphi\cos\psi\frac{\partial\varphi}{\partial x} - \cos\varphi\sin\psi\frac{\partial\psi}{\partial x}, \\ 0 = -\sin\varphi\sin\psi\frac{\partial\varphi}{\partial x} + \cos\varphi\cos\psi\frac{\partial\psi}{\partial x}. \end{cases}$$

联立求解，得

$$\frac{\partial\varphi}{\partial x} = -\frac{\cos\psi}{\sin\varphi}, \quad \frac{\partial\psi}{\partial x} = -\frac{\sin\psi}{\cos\varphi}.$$

于是，

$$\begin{aligned} \frac{\partial z}{\partial x} &= \cos\varphi\frac{\partial\varphi}{\partial x} = -\operatorname{ctg}\varphi\cos\psi, \\ \frac{\partial^2 z}{\partial x^2} &= \frac{\partial}{\partial\varphi}\left(\frac{\partial z}{\partial x}\right)\cdot\frac{\partial\varphi}{\partial x} + \frac{\partial}{\partial\psi}\left(\frac{\partial z}{\partial x}\right)\cdot\frac{\partial\psi}{\partial x} \\ &= \frac{\cos\psi}{\sin^2\varphi}\cdot\left(-\frac{\cos\psi}{\sin\varphi}\right) + \operatorname{ctg}\varphi\sin\psi\cdot\left(-\frac{\sin\psi}{\cos\varphi}\right) \\ &= -\frac{\cos^2\psi + \sin^2\psi\sin^2\varphi}{\sin^3\varphi} = -\frac{\sin^2\varphi + \cos^2\varphi\cos^2\psi}{\sin^3\varphi}. \end{aligned}$$

注 本题也可消去 φ, ψ 求 $\frac{\partial^2 z}{\partial x^2}$. 事实上，

$$\begin{aligned} x^2 + y^2 + z^2 &= \cos^2\varphi\cos^2\psi + \cos^2\varphi\sin^2\psi + \sin^2\varphi \\ &= \cos^2\varphi + \sin^2\varphi = 1. \end{aligned}$$

于是，

$$\begin{aligned} 2x + 2z\frac{\partial z}{\partial x} &= 0, \quad \frac{\partial z}{\partial x} = -\frac{x}{z}, \\ \frac{\partial^2 z}{\partial x^2} &= -\frac{z - x\frac{\partial z}{\partial x}}{z^2} = -\frac{z^2 + x^2}{z^3}. \end{aligned}$$

$$= \frac{\sin^2\varphi + \cos^2\varphi \cos^2\psi}{\sin^2\varphi}.$$

3409. 设 $x = u \cos v$, $y = u \sin v$, $z = v$, 求 $\frac{\partial^2 z}{\partial x^2}$, $\frac{\partial^2 z}{\partial x \partial y}$ 及

$$\frac{\partial^2 z}{\partial y^2}.$$

解 本题求微分, 可将所有的二阶偏导函数一起求出.

$$dx = \cos v du - u \sin v dv,$$

$$dy = \sin v du + u \cos v dv.$$

联立求解, 得

$$du = \cos v dx + \sin v dy,$$

$$dv = \frac{1}{u}(-\sin v dx + \cos v dy),$$

$$u dv = -\sin v dx + \cos v dy.$$

再对上式微分一次, 得

$$u d^2 v + du dv = -\cos v dv dx - \sin v dv dy$$

$$= -du dv,$$

于是,

$$d^2 z = d^2 v = -\frac{2}{u} du dv = -\frac{2}{u^2} (\cos v dx + \sin v dy)$$

$$\cdot (-\sin v dx + \cos v dy)$$

$$= \frac{2}{u^2} (\sin v \cos v dx^2 - \cos 2v dx dy - \sin v \cos v dy^2),$$

从而有

$$\frac{\partial^2 z}{\partial x^2} = \frac{2\sin v \cos v}{u^2} = \frac{\sin 2v}{u^2},$$

$$\frac{\partial^2 z}{\partial x \partial y} = -\frac{\cos 2v}{u^2}, \quad \frac{\partial^2 z}{\partial y^2} = -\frac{\sin 2v}{u^2}.$$

注 本题也可消去 u, v , 由 $z = v = \arctg \frac{y}{x}$ 获解.

3410. 设 $z = z(x, y)$ 为由方程组:

$$x = e^{u+v}, \quad y = e^{u-v}, \quad z = uv$$

(u 及 v 为参数) 所定义的函数, 求当 $u = 0$ 及 $v = 0$ 时的 dz 及 d^2z .

$$\text{解} \quad dx \Big|_{\substack{u=0 \\ v=0}} = e^{u+v}(du+dv) \Big|_{\substack{u=0 \\ v=0}} = du+dv,$$

$$dy \Big|_{\substack{u=0 \\ v=0}} = e^{u-v}(du-dv) \Big|_{\substack{u=0 \\ v=0}} = du-dv.$$

于是, 当 $u = 0$ 及 $v = 0$ 时,

$$du = \frac{1}{2}(dx+dy), \quad dv = \frac{1}{2}(dx-dy);$$

$$dz = u dv + v du = 0;$$

$$\begin{aligned} d^2z &= u d^2v + 2du dv + v d^2u = 2du dv \\ &= 2 \left(\frac{dx+dy}{2} \right) \left(\frac{dx-dy}{2} \right) = \frac{1}{2}(dx^2 - dy^2). \end{aligned}$$

3411. 设 $z = x^2 + y^2$, 其中 $y = y(x)$ 为由方程 $x^2 - xy + y^2$

$= 1$ 所定义的函数, 求 $\frac{dz}{dx}$ 及 $\frac{d^2z}{dx^2}$.

解 先由 $x^2 - xy + y^2 = 1$ 求 $\frac{dy}{dx}$ 及 $\frac{d^2y}{dx^2}$.

$$\begin{aligned} 2x - y - xy' + 2yy' &= 0, \\ 2 - 2y' - xy'' + 2y'^2 + 2yy'' &= 0. \end{aligned} \quad (1)$$

于是,

$$y' = \frac{2x - y}{x - 2y}, \quad y'' = \frac{6(x^2 - xy + y^2)}{(x - 2y)^3} = \frac{6}{(x - 2y)^3}.$$

下面求 $\frac{dz}{dx}$ 及 $\frac{d^2z}{dx^2}$.

$$\frac{dz}{dx} = 2x + 2yy' = 2x + 2y \cdot \frac{2x - y}{x - 2y} = \frac{2(x^2 - y^2)}{x - 2y},$$

$$\begin{aligned} \frac{d^2z}{dx^2} &= 2 + 2y'^2 + 2y''y = 2y' + xy'' \\ &= \frac{2(2x - y)}{x - 2y} + \frac{6x}{(x - 2y)^3}. \end{aligned}$$

3412. 设 $u = \frac{x+z}{y+z}$, 其中 z 为由方程式 $ze^z = xe^x + ye^y$ 所

定义的函数, 求 $\frac{\partial u}{\partial x}$ 及 $\frac{\partial u}{\partial y}$.

解 将 $ze^z = xe^x + ye^y$ 两端微分, 得

$$e^z(1+z)dz = e^x(1+x)dx + e^y(1+y)dy.$$

又因

$$\begin{aligned} du &= \frac{1}{(y+z)^2} [(y+z)dx + (y+z)dz \\ &\quad - (x+z)dy - (x+z)dz] \\ &= \frac{1}{(y+z)^2} [(y+z)dx - (x+z)dy + (y-x)dz] \end{aligned}$$

$$= \frac{1}{(y+z)^2} [(y+z)dx - (x+z)dy + \frac{(y-x)e^x(1+x)}{e^z(1+z)}dx + \frac{(y-x)e^y(1+y)}{e^z(1+z)}dy],$$

故得

$$\frac{\partial u}{\partial x} = \frac{1}{y+z} + \frac{(x+1)(y-x)}{(z+1)(y+z)^2} e^{x-z},$$

$$\frac{\partial u}{\partial y} = -\frac{x+z}{(y+z)^2} + \frac{(y+1)(y-x)}{(z+1)(y+z)^2} e^{y-z}.$$

3413. 设方程:

$$x = \varphi(u, v), \quad y = \psi(u, v), \quad z = \chi(u, v)$$

定义 z 为 x 和 y 的函数. 求 $\frac{\partial z}{\partial x}$ 和 $\frac{\partial z}{\partial y}$.

解 对 x 求偏导函数, 得

$$1 = \frac{\partial \varphi}{\partial u} \frac{\partial u}{\partial x} + \frac{\partial \varphi}{\partial v} \frac{\partial v}{\partial x}, \quad (1)$$

$$0 = \frac{\partial \psi}{\partial u} \frac{\partial u}{\partial x} + \frac{\partial \psi}{\partial v} \frac{\partial v}{\partial x}, \quad (2)$$

$$\frac{\partial z}{\partial x} = \frac{\partial \chi}{\partial u} \frac{\partial u}{\partial x} + \frac{\partial \chi}{\partial v} \frac{\partial v}{\partial x}. \quad (3)$$

由 (1) 及 (2) 解得

$$\frac{\partial u}{\partial x} = \frac{1}{I} \frac{\partial \psi}{\partial v}, \quad \frac{\partial v}{\partial x} = -\frac{1}{I} \frac{\partial \psi}{\partial u}, \quad (4)$$

其中

$$I = \begin{vmatrix} \frac{\partial \varphi}{\partial u} & \frac{\partial \varphi}{\partial v} \\ \frac{\partial \psi}{\partial u} & \frac{\partial \psi}{\partial v} \end{vmatrix} = \frac{\partial \varphi}{\partial u} \frac{\partial \psi}{\partial v} - \frac{\partial \psi}{\partial u} \frac{\partial \varphi}{\partial v}.$$

再将 (4) 的结果代入 (3), 即得

$$\frac{\partial z}{\partial x} = -\frac{1}{I} \left(\frac{\partial \psi}{\partial u} \frac{\partial z}{\partial v} - \frac{\partial \psi}{\partial v} \frac{\partial z}{\partial u} \right),$$

同法求得

$$\frac{\partial z}{\partial y} = -\frac{1}{I} \left(\frac{\partial \varphi}{\partial v} \frac{\partial z}{\partial u} - \frac{\partial \varphi}{\partial u} \frac{\partial z}{\partial v} \right).$$

3414. 设:

$$x = \varphi(u, v), \quad y = \psi(u, v).$$

求反函数: $u = u(x, y)$ 和 $v = v(x, y)$ 的一阶和二阶偏导函数.

解 微分二次, 得

$$dx = \varphi'_1 du + \varphi'_2 dv, \quad (1)$$

$$dy = \psi'_1 du + \psi'_2 dv, \quad (2)$$

$$0 = \varphi''_{11} du^2 + 2\varphi''_{12} dudv + \varphi''_{22} dv^2 + \varphi'_1 d^2u + \varphi'_2 d^2v, \quad (3)$$

$$0 = \psi''_{11} du^2 + 2\psi''_{12} dudv + \psi''_{22} dv^2 + \psi'_1 d^2u + \psi'_2 d^2v. \quad (4)$$

其中右下角标号 1, 2 分别代表对 u, v 的偏导函数, 余类推.

令 $I = \varphi'_1 \psi'_2 - \varphi'_2 \psi'_1$, 则由 (1), (2) 可解得

$$du = \frac{1}{I}(\psi'_2 dx - \varphi'_2 dy), \quad (5)$$

$$dv = \frac{1}{I}(\varphi'_1 dy - \psi'_1 dx). \quad (6)$$

于是,

$$\frac{\partial u}{\partial x} = \frac{1}{I}\psi'_2 = \frac{1}{I}\frac{\partial \psi}{\partial v}, \quad \frac{\partial u}{\partial y} = -\frac{1}{I}\frac{\partial \varphi}{\partial v},$$

$$\frac{\partial v}{\partial x} = -\frac{1}{I}\frac{\partial \psi}{\partial u}, \quad \frac{\partial v}{\partial y} = \frac{1}{I}\frac{\partial \varphi}{\partial u}.$$

由 (3), (4) 解出 d^2u, d^2v , 并把 (5), (6) 的结果代入, 即得

$$\begin{aligned} d^2u &= \frac{1}{I}[\varphi'_2(\psi''_{11}du^2 + 2\psi''_{12}dudv + \psi''_{22}dv^2) \\ &\quad - \psi'_2(\varphi''_{11}du^2 + 2\varphi''_{12}dudv + \varphi''_{22}dv^2)] \\ &= \frac{1}{I^3}[(\varphi'_2\psi''_{11} - \psi'_2\varphi''_{11})(\psi'_2 dx - \varphi'_2 dy)^2 \\ &\quad + 2(\varphi'_2\psi''_{12} - \psi'_2\varphi''_{12})(\psi'_2 dx - \varphi'_2 dy)(\varphi'_1 dy \\ &\quad - \psi'_1 dx) + (\varphi'_2\psi''_{22} - \psi'_2\varphi''_{22})(\varphi'_1 dy - \psi'_1 dx)^2] \\ &= \frac{\partial^2 u}{\partial x^2} dx^2 + 2\frac{\partial^2 u}{\partial x \partial y} dx dy + \frac{\partial^2 u}{\partial y^2} dy^2. \end{aligned}$$

比较上式两端的系数, 即得

$$\begin{aligned} \frac{\partial^2 u}{\partial x^2} &= \frac{1}{I^3} \left[\left(\frac{\partial \varphi}{\partial v} \frac{\partial^2 \psi}{\partial u^2} - \frac{\partial \psi}{\partial v} \frac{\partial^2 \varphi}{\partial u^2} \right) \right. \\ &\quad \left. \cdot \left(\frac{\partial \psi}{\partial v} \right)^2 - 2 \left(\frac{\partial \varphi}{\partial v} \frac{\partial^2 \psi}{\partial u \partial v} - \frac{\partial \psi}{\partial v} \frac{\partial^2 \varphi}{\partial u \partial v} \right) \right] \end{aligned}$$

$$\cdot \frac{\partial \psi}{\partial u} \frac{\partial \psi}{\partial v} + \left(\frac{\partial \varphi}{\partial v} \frac{\partial^2 \psi}{\partial v^2} - \frac{\partial \psi}{\partial v} \frac{\partial^2 \varphi}{\partial v^2} \right) \left(\frac{\partial \psi}{\partial u} \right)^2 \Bigg],$$

$$\frac{\partial^2 u}{\partial x \partial y} = \frac{1}{I^3} \left[\left(\frac{\partial \psi}{\partial v} \frac{\partial^2 \varphi}{\partial u^2} - \frac{\partial \varphi}{\partial v} \frac{\partial^2 \psi}{\partial u^2} \right)$$

$$\cdot \frac{\partial \varphi}{\partial v} \frac{\partial \psi}{\partial v} - \left(\frac{\partial \psi}{\partial v} \frac{\partial^2 \varphi}{\partial u \partial v} - \frac{\partial \varphi}{\partial v} \frac{\partial^2 \psi}{\partial u \partial v} \right)$$

$$\cdot \left(\frac{\partial \varphi}{\partial u} \frac{\partial \psi}{\partial v} + \frac{\partial \varphi}{\partial v} \frac{\partial \psi}{\partial u} \right) + \left(\frac{\partial \psi}{\partial v} \frac{\partial^2 \varphi}{\partial v^2}$$

$$- \frac{\partial \varphi}{\partial v} \frac{\partial^2 \psi}{\partial v^2} \right) \frac{\partial \varphi}{\partial u} \frac{\partial \psi}{\partial u} \Bigg].$$

$$\frac{\partial^2 u}{\partial y^2} = \frac{1}{I^3} \left[\left(\frac{\partial \varphi}{\partial v} \frac{\partial^2 \psi}{\partial u^2} - \frac{\partial \psi}{\partial v} \frac{\partial^2 \varphi}{\partial u^2} \right) \left(\frac{\partial \varphi}{\partial v} \right)^2 \right.$$

$$- 2 \left(\frac{\partial \varphi}{\partial v} \frac{\partial^2 \psi}{\partial u \partial v} - \frac{\partial \psi}{\partial v} \frac{\partial^2 \varphi}{\partial u \partial v} \right)$$

$$\cdot \left. \frac{\partial \varphi}{\partial u} \frac{\partial \varphi}{\partial v} + \left(\frac{\partial \varphi}{\partial v} \frac{\partial^2 \psi}{\partial v^2} - \frac{\partial \psi}{\partial v} \frac{\partial^2 \varphi}{\partial v^2} \right) \left(\frac{\partial \varphi}{\partial u} \right)^2 \right].$$

同法可求得 d^2v 和 $\frac{\partial^2 v}{\partial x^2}$, $\frac{\partial^2 v}{\partial x \partial y}$, $\frac{\partial^2 v}{\partial y^2}$.

3415. 设 (a) $x = u \cos \frac{v}{u}$, $y = u \sin \frac{v}{u}$;

$$(b) x = e^u + u \sin v, \quad y = e^u - u \cos v,$$

求 $\frac{\partial u}{\partial x}$, $\frac{\partial u}{\partial y}$, $\frac{\partial v}{\partial x}$, $\frac{\partial v}{\partial y}$.

解 利用 3414 题的结果求之.

(a) $\varphi(u, v) = u \cos \frac{v}{u}$, $\psi(u, v) = u \sin \frac{v}{u}$. 于是,

$$\frac{\partial \varphi}{\partial u} = \cos \frac{v}{u} + \frac{v}{u} \sin \frac{v}{u}, \quad \frac{\partial \varphi}{\partial v} = -\sin \frac{v}{u},$$

$$\frac{\partial \psi}{\partial u} = \sin \frac{v}{u} - \frac{v}{u} \cos \frac{v}{u}, \quad \frac{\partial \psi}{\partial v} = \cos \frac{v}{u},$$

$$I = \frac{\partial \varphi}{\partial u} \frac{\partial \psi}{\partial v} - \frac{\partial \varphi}{\partial v} \frac{\partial \psi}{\partial u} = \left(\cos \frac{v}{u} \right.$$

$$\left. + \frac{v}{u} \sin \frac{v}{u} \right) \cos \frac{v}{u} - \left(-\sin \frac{v}{u} \right)$$

$$\cdot \left(\sin \frac{v}{u} - \frac{v}{u} \cos \frac{v}{u} \right) = 1.$$

从而得

$$\frac{\partial u}{\partial x} = \frac{1}{I} \frac{\partial \psi}{\partial v} = \cos \frac{v}{u}, \quad \frac{\partial u}{\partial y} = -\frac{1}{I} \frac{\partial \varphi}{\partial v} = \sin \frac{v}{u},$$

$$\frac{\partial v}{\partial x} = -\frac{1}{I} \frac{\partial \psi}{\partial u} = \frac{v}{u} \cos \frac{v}{u} - \sin \frac{v}{u},$$

$$\frac{\partial v}{\partial y} = \frac{1}{I} \frac{\partial \varphi}{\partial u} = \frac{v}{u} \sin \frac{v}{u} + \cos \frac{v}{u}.$$

(b) $\varphi(u, v) = e^x + u \sin v$, $\psi(u, v) = e^x - u \cos v$.

于是,

$$\frac{\partial \varphi}{\partial u} = e^x + \sin v, \quad \frac{\partial \varphi}{\partial v} = u \cos v,$$

$$\frac{\partial \psi}{\partial u} = e^x - \cos v, \quad \frac{\partial \psi}{\partial v} = u \sin v,$$

$$I = (e^x + \sin v)u \sin v - (e^x - \cos v)u \cos v \\ = u(e^x(\sin v - \cos v) + 1).$$

从而得

$$\frac{\partial u}{\partial x} = \frac{\sin v}{e^x(\sin v - \cos v) + 1},$$

$$\frac{\partial u}{\partial y} = -\frac{\cos v}{e^x(\sin v - \cos v) + 1},$$

$$\frac{\partial v}{\partial x} = -\frac{e^x - \cos v}{u(e^x(\sin v - \cos v) + 1)},$$

$$\frac{\partial v}{\partial y} = \frac{e^x + \sin v}{u(e^x(\sin v - \cos v) + 1)}.$$

3416. 函数 $u = u(x)$ 由方程组

$$u = f(x, y, z), \quad g(x, y, z) = 0, \\ h(x, y, z) = 0$$

定义, 求 $\frac{du}{dx}$ 和 $\frac{d^2u}{dx^2}$.

解 微分得

$$du = f'_x dx + f'_y dy + f'_z dz = \left(dx \frac{\partial}{\partial x} + dy \frac{\partial}{\partial y} \right. \\ \left. + dz \frac{\partial}{\partial z} \right) f, \quad (1)$$

$$0 = g'_x dx + g'_y dy + g'_z dz = \left(dx \frac{\partial}{\partial x} + dy \frac{\partial}{\partial y} \right. \\ \left. + dz \frac{\partial}{\partial z} \right) g,$$

$$0 = h'_x dx + h'_y dy + h'_z dz = \left(dx \frac{\partial}{\partial x} + dy \frac{\partial}{\partial y} + dz \frac{\partial}{\partial z} \right) h. \quad (3)$$

令 $\frac{\partial(g, h)}{\partial(y, z)} = I_1$, $\frac{\partial(g, h)}{\partial(z, x)} = I_2$, $\frac{\partial(g, h)}{\partial(x, y)} = I_3$, 则

由(2), (3)可解得

$$dy = \frac{I_2}{I_1} dx, \quad dz = \frac{I_3}{I_1} dx.$$

将 dy , dz 代入(1), 得

$$\begin{aligned} du &= f'_x dx + f'_y \cdot \frac{I_2}{I_1} dx + f'_z \cdot \frac{I_3}{I_1} dx \\ &= \frac{1}{I_1} (I_1 f'_x + I_2 f'_y + I_3 f'_z) dx = \frac{I}{I_1} dx, \end{aligned}$$

其中 $I = \frac{D(f, g, h)}{D(x, y, z)}$. 于是,

$$\frac{du}{dx} = \frac{I}{I_1}.$$

对(1), (2), (3)式再求一次微分, 得

$$\begin{aligned} d^2u &= \left(dx \frac{\partial}{\partial x} + dy \frac{\partial}{\partial y} + dz \frac{\partial}{\partial z} \right)^2 f + f''_y d^2y \\ &\quad + f''_z d^2z, \end{aligned} \quad (4)$$

$$0 = \left(dx \frac{\partial}{\partial x} + dy \frac{\partial}{\partial y} + dz \frac{\partial}{\partial z} \right)^2 g + g''_y d^2y$$

$$+g'_z d^2 z, \quad (5)$$

$$0 = \left(dx \frac{\partial}{\partial x} + dy \frac{\partial}{\partial y} + dz \frac{\partial}{\partial z} \right)^2 h + h'_y d^2 y + h'_z d^2 z. \quad (6)$$

于是,

$$\begin{aligned} d^2 y &= \frac{1}{I_1} \left[g'_z \cdot \left(dx \frac{\partial}{\partial x} + dy \frac{\partial}{\partial y} + dz \frac{\partial}{\partial z} \right)^2 h \right. \\ &\quad \left. - h'_y \cdot \left(dx \frac{\partial}{\partial x} + dy \frac{\partial}{\partial y} + dz \frac{\partial}{\partial z} \right)^2 g \right], \\ d^2 z &= \frac{1}{I_1} \left[h'_y \cdot \left(dx \frac{\partial}{\partial x} + dy \frac{\partial}{\partial y} + dz \frac{\partial}{\partial z} \right)^2 g - g'_z \right. \\ &\quad \left. \cdot \left(dx \frac{\partial}{\partial x} + dy \frac{\partial}{\partial y} + dz \frac{\partial}{\partial z} \right)^2 h \right]. \end{aligned}$$

令 $\frac{\partial(h, f)}{\partial(y, z)} = I_4$, $\frac{\partial(f, g)}{\partial(y, z)} = I_5$, 并将 $d^2 y$ 及 $d^2 z$

代入(4), 即得

$$\begin{aligned} d^2 u &= \frac{1}{I_1} \left[I_1 \cdot \left(dx \frac{\partial}{\partial x} + dy \frac{\partial}{\partial y} + dz \frac{\partial}{\partial z} \right)^2 f \right. \\ &\quad + I_4 \cdot \left(dx \frac{\partial}{\partial x} + dy \frac{\partial}{\partial y} + dz \frac{\partial}{\partial z} \right)^2 g \\ &\quad \left. + I_5 \cdot \left(dx \frac{\partial}{\partial x} + dy \frac{\partial}{\partial y} + dz \frac{\partial}{\partial z} \right)^2 h \right], \end{aligned}$$

再以 $dy = \frac{I_2}{I_1} dx$ 及 $dz = \frac{I_3}{I_1} dx$ 代入上式, 即得

$$\begin{aligned} \frac{d^2 u}{dx^2} = & \frac{1}{I_1^3} \left[I_1 \cdot \left(I_1 \frac{\partial}{\partial x} + I_2 \frac{\partial}{\partial y} + I_3 \frac{\partial}{\partial z} \right)^2 f \right. \\ & + I_4 \cdot \left(I_1 \frac{\partial}{\partial x} + I_2 \frac{\partial}{\partial y} + I_3 \frac{\partial}{\partial z} \right)^2 g \\ & \left. + I_5 \cdot \left(I_1 \frac{\partial}{\partial x} + I_2 \frac{\partial}{\partial y} + I_3 \frac{\partial}{\partial z} \right)^2 h \right]. \end{aligned}$$

3417. 函数 $u = u(x, y)$ 由方程组

$$u = f(x, y, z, t), \quad g(y, z, t) = 0, \quad h(z, t) = 0$$

定义. 求 $\frac{\partial u}{\partial x}$ 和 $\frac{\partial u}{\partial y}$.

解 微分得

$$du = f'_x dx + f'_y dy + f'_z dz + f'_t dt, \quad (1)$$

$$0 = g'_y dy + g'_z dz + g'_t dt, \quad (2)$$

$$0 = h'_z dz + h'_t dt. \quad (3)$$

令 $I_1 = \frac{\partial(g, h)}{\partial(z, t)}$, 则由(2), (3)可解得

$$dz = \frac{1}{I_1} \cdot (-g'_y h'_t) dy, \quad dt = \frac{1}{I_1} \cdot (g'_y h'_z) dy.$$

将 dz 及 dt 代入(1)式, 得

$$du = f'_x dx + f'_y dy - \frac{g'_y}{I_1} (f'_z h'_t - f'_t h'_z) dy.$$

于是,

$$\frac{\partial u}{\partial x} = f'_x, \quad \frac{\partial u}{\partial y} = f'_y + g'_y \cdot \frac{I_2}{I_1},$$

$$\text{其中 } I_2 = \frac{\partial(h, f)}{\partial(z, t)}.$$

3418. 设:

$$x = f(u, v, w), \quad y = g(u, v, w), \quad z = h(u, v, w).$$

$$\text{求 } \frac{\partial u}{\partial x}, \quad \frac{\partial u}{\partial y} \text{ 和 } \frac{\partial u}{\partial z}.$$

解 微分得

$$dx = f'_u du + f'_v dv + f'_w dw,$$

$$dy = g'_u du + g'_v dv + g'_w dw,$$

$$dz = h'_u du + h'_v dv + h'_w dw.$$

$$\text{令 } I = \frac{D(f, g, h)}{D(u, v, w)}, \text{ 则有}$$

$$du = \frac{1}{I} \begin{vmatrix} dx & f'_v & f'_w \\ dy & g'_v & g'_w \\ dz & h'_v & h'_w \end{vmatrix} = \frac{I_1}{I} dx + \frac{I_2}{I} dy + \frac{I_3}{I} dz,$$

$$\text{其中 } I_1 = \frac{\partial(g, h)}{\partial(v, w)}, \quad I_2 = \frac{\partial(h, f)}{\partial(v, w)}, \quad I_3 = \frac{\partial(f, g)}{\partial(v, w)}.$$

于是,

$$\frac{\partial u}{\partial x} = \frac{I_1}{I}, \quad \frac{\partial u}{\partial y} = \frac{I_2}{I}, \quad \frac{\partial u}{\partial z} = \frac{I_3}{I}.$$

3419. 设函数 $z = z(x, y)$ 满足方程组

$$f(x, y, z, t) = 0, \quad g(x, y, z, t) = 0,$$

式中 t 为参变数. 求 dz .

解 微分得

$$f'_x dx + f'_y dy + f'_z dz + f'_t dt = 0,$$

$$g'_x dx + g'_y dy + g'_z dz + g'_t dt = 0.$$

把 dz, dt 看作未知数, 其它为系数. 解之得

$$dz = \frac{1}{I_3} \{ f'_t \cdot (g'_x dx + g'_y dy) - g'_t \cdot (f'_x dx + f'_y dy) \}$$

$$= \frac{1}{I_3} \{ (f'_t g'_x - g'_t f'_x) dx + (f'_t g'_y - g'_t f'_y) dy \}$$

$$= - \frac{I_1 dx + I_2 dy}{I_3},$$

其中 $I_1 = \frac{\partial(f, g)}{\partial(x, t)}$, $I_2 = \frac{\partial(f, g)}{\partial(y, t)}$, $I_3 = \frac{\partial(f, g)}{\partial(z, t)}$.

3420. 设 $u = f(z)$, 其中 z 为由方程式 $z = x + y\varphi(z)$ 所定义的为变数 x 和 y 的隐函数. 证明拉格朗日公式

$$\frac{\partial^n u}{\partial y^n} = \frac{\partial^{n-1}}{\partial x^{n-1}} \left\{ [\varphi(z)]^n \frac{\partial u}{\partial x} \right\}.$$

证 $dz = dx + \varphi(z)dy + y\varphi'(z)dz$. 于是,

$$\frac{\partial z}{\partial x} = \frac{1}{1 - y\varphi'(z)},$$

$$\frac{\partial z}{\partial y} = \frac{\varphi(z)}{1 - y\varphi'(z)} = \varphi(z) \frac{\partial z}{\partial x}.$$

从而得

$$\frac{\partial u}{\partial y} = f'(z) \frac{\partial z}{\partial y} = f'(z) \varphi(z) \frac{\partial z}{\partial x} = \varphi(z) \frac{\partial u}{\partial x},$$

即当 $n = 1$ 时, 拉格朗日公式为真.

对于任意可微函数 $g(z)$, 有

$$\begin{aligned}
 \frac{\partial}{\partial y} \left[g(z) \frac{\partial u}{\partial x} \right] &= g'(z) \frac{\partial z}{\partial y} \frac{\partial u}{\partial x} + g(z) \frac{\partial^2 u}{\partial x \partial y} \\
 &= \varphi(z) g'(z) \frac{\partial z}{\partial x} \frac{\partial u}{\partial x} + g(z) \frac{\partial}{\partial x} \left(\frac{\partial u}{\partial y} \right) \\
 &= \varphi(z) g'(z) \frac{\partial z}{\partial x} \frac{\partial u}{\partial x} + g(z) \frac{\partial}{\partial x} \left[\varphi(z) \frac{\partial u}{\partial x} \right] \\
 &= \varphi(z) g'(z) \frac{\partial z}{\partial x} \frac{\partial u}{\partial x} + \varphi'(z) g(z) \frac{\partial z}{\partial x} \frac{\partial u}{\partial x} \\
 &\quad + \varphi(z) g(z) \frac{\partial^2 u}{\partial x^2} \\
 &= \frac{\partial}{\partial x} \left[\varphi(z) g(z) \frac{\partial u}{\partial x} \right].
 \end{aligned}$$

令 $g(z) = \varphi(z)$, 得

$$\begin{aligned}
 \frac{\partial^2 u}{\partial y^2} &= \frac{\partial}{\partial y} \left(\frac{\partial u}{\partial y} \right) = \frac{\partial}{\partial y} \left[\varphi(z) \frac{\partial u}{\partial x} \right] \\
 &= \frac{\partial}{\partial x} \left[\varphi^2(z) \frac{\partial u}{\partial x} \right],
 \end{aligned}$$

即当 $n=2$ 时, 拉格朗日公式也为真. 设当 $n=k$ 时, 公式为真, 即有

$$\frac{\partial^k u}{\partial y^k} = \frac{\partial^{k-1}}{\partial x^{k-1}} \left[\varphi^k(z) \frac{\partial u}{\partial x} \right].$$

于是,

$$\frac{\partial^{k+1} u}{\partial y^{k+1}} = \frac{\partial}{\partial y} \left\{ \frac{\partial^{k-1}}{\partial x^{k-1}} \left[\varphi^k(z) \frac{\partial u}{\partial x} \right] \right\}$$

$$\begin{aligned}
&= \frac{\partial^{k-1}}{\partial x^{k-1}} \left\{ \frac{\partial}{\partial y} \left[\varphi^k(z) \frac{\partial u}{\partial x} \right] \right\} \\
&= \frac{\partial^{k-1}}{\partial x^{k-1}} \left\{ \frac{\partial}{\partial x} \left[\varphi^{k+1}(z) \frac{\partial u}{\partial x} \right] \right\} \\
&= \frac{\partial^k}{\partial x^k} \left[\varphi^{k+1}(z) \frac{\partial u}{\partial x} \right],
\end{aligned}$$

即当 $n=k+1$ 时, 拉格朗日公式也为真. 于是, 对于一切自然数 n , 均有

$$\frac{\partial^n u}{\partial y^n} = \frac{\partial^{n-1}}{\partial x^{n-1}} \left[\varphi^n(z) \frac{\partial u}{\partial x} \right].$$

3421. 证明: 由方程

$$\Phi(x-az, y-bz) = 0 \quad (1)$$

[其中 $\Phi(u, v)$ 是变数 u, v 的任意可微分函数, a 和 b 为常数] 所定义的函数 $z=z(x, y)$ 为方程

$$a \frac{\partial z}{\partial x} + b \frac{\partial z}{\partial y} = 1$$

的解. 说明曲面(1)的几何性质.

解 由于

$$\Phi'_1 \cdot \left(1 - a \frac{\partial z}{\partial x} \right) - b \Phi'_2 \cdot \frac{\partial z}{\partial x} = 0,$$

$$-\Phi'_1 \cdot a \frac{\partial z}{\partial y} + \Phi'_2 \cdot \left(1 - b \frac{\partial z}{\partial y} \right) = 0,$$

故有

$$\frac{\partial z}{\partial x} = \frac{\Phi'_1}{a\Phi'_1 + b\Phi'_2}, \quad \frac{\partial z}{\partial y} = \frac{\Phi'_2}{a\Phi'_1 + b\Phi'_2}.$$

将上面二个等式依次乘以 a, b , 然后相加, 即得

$$a \frac{\partial z}{\partial x} + b \frac{\partial z}{\partial y} = 1,$$

这就说明 $z = z(x, y)$ 为方程 $a \frac{\partial z}{\partial x} + b \frac{\partial z}{\partial y} = 1$ 的解.

等式 $a \frac{\partial z}{\partial x} + b \frac{\partial z}{\partial y} - 1 = 0$ 表示曲面 (1) 上任一

点 $P_1(x_1, y_1, z_1)$ 的法向量 $\vec{n}_1 = \left\{ \frac{\partial z}{\partial x} \Big|_{P_1}, \frac{\partial z}{\partial y} \Big|_{P_1}, \right.$

$-1 \Big\}$ 皆与向量 $\vec{r}_1 = \{a, b, 1\}$ 垂直. 过点 P_1 作平行于 \vec{r}_1 的直线 l_1 :

$$\frac{x-x_1}{a} = \frac{y-y_1}{b} = \frac{z-z_1}{1}.$$

易知 l_1 上的点皆在曲面 (1) 上. 于是, 曲面 (1) 是母线平行于 \vec{r}_1 的柱面.

3422. 证明: 由方程

$$\Phi\left(\frac{x-x_0}{z-z_0}, \frac{y-y_0}{z-z_0}\right) = 0 \quad (2)$$

[其中 $\Phi(u, v)$ 是变数 u 和 v 的任意可微分函数] 所定义的函数 $z = z(x, y)$ 满足方程式

$$(x-x_0) \frac{\partial z}{\partial x} + (y-y_0) \frac{\partial z}{\partial y} = z - z_0.$$

说明曲面 (2) 的几何性质.

解 由于

$$\begin{aligned} \Phi_1' \cdot \frac{z-z_0-(x-x_0)\frac{\partial z}{\partial x}}{(z-z_0)^2} - \Phi_2' \cdot \frac{(y-y_0)\frac{\partial z}{\partial x}}{(z-z_0)^2} &= 0, \\ -\Phi_1' \cdot \frac{(x-x_0)\frac{\partial z}{\partial y}}{(z-z_0)^2} + \Phi_2' \cdot \frac{z-z_0-(y-y_0)\frac{\partial z}{\partial y}}{(z-z_0)^2} &= 0, \end{aligned}$$

故有

$$\frac{\partial z}{\partial x} = \frac{(z-z_0)\Phi_1'}{(x-x_0)\Phi_1' + (y-y_0)\Phi_2'},$$

$$\frac{\partial z}{\partial y} = \frac{(z-z_0)\Phi_2'}{(x-x_0)\Phi_1' + (y-y_0)\Phi_2'}.$$

将上面二个等式依次乘以 $x-x_0$ 及 $y-y_0$, 然后相加, 即得

$$(x-x_0)\frac{\partial z}{\partial x} + (y-y_0)\frac{\partial z}{\partial y} = z-z_0,$$

本题获证.

等式 $(x-x_0)\frac{\partial z}{\partial x} + (y-y_0)\frac{\partial z}{\partial y} - (z-z_0) = 0$ 表示曲面 (2) 在其上任一点 $P_2(x_2, y_2, z_2)$ 的法向量 $\vec{n}_2 = \left\{ \frac{\partial z}{\partial x} \Big|_{P_2}, \frac{\partial z}{\partial y} \Big|_{P_2}, -1 \right\}$ 与向量 $\vec{r}_2 = \{x_2-x_0, y_2-y_0, z_2-z_0\}$ 垂直. 作过点 $P_0(x_0, y_0, z_0)$ 、 $P_2(x_2, y_2, z_2)$ 的直线 l_2 :

$$\frac{x-x_0}{x_2-x_0} = \frac{y-y_0}{y_2-y_0} = \frac{z-z_0}{z_2-z_0}.$$

易知 l_2 上的任一点皆在曲面(2)上. 于是, 曲面(2)是顶点在 P_0 的锥面.

3423. 证明: 由方程

$$ax + by + cz = \Phi(x^2 + y^2 + z^2) \quad (3)$$

[其中 $\Phi(u)$ 是变数 u 的任意可微分函数, a , b 和 c 为常数] 所定义的函数 $z = z(x, y)$ 满足方程

$$(cy - bz) \frac{\partial z}{\partial x} + (az - cx) \frac{\partial z}{\partial y} = bx - ay.$$

说明曲面(3)的几何性质.

解 由于

$$a + c \frac{\partial z}{\partial x} = \Phi' \cdot \left(2x + 2z \frac{\partial z}{\partial x} \right),$$

$$b + c \frac{\partial z}{\partial y} = \Phi' \cdot \left(2y + 2z \frac{\partial z}{\partial y} \right),$$

故有

$$\frac{\partial z}{\partial x} = \frac{2x\Phi' - a}{c - 2z\Phi'}, \quad \frac{\partial z}{\partial y} = \frac{2y\Phi' - b}{c - 2z\Phi'}.$$

将上面二个等式依次乘以 $(cy - bz)$ 及 $(az - cx)$, 然后相加, 即得

$$\begin{aligned} & (cy - bz) \frac{\partial z}{\partial x} + (az - cx) \frac{\partial z}{\partial y} \\ &= \frac{(2x\Phi' - a)(cy - bz) + (2y\Phi' - b)(az - cx)}{c - 2z\Phi'} \end{aligned}$$

$$= \frac{(c - 2z\Phi')(bx - ay)}{c - 2z\Phi'} = bx - ay,$$

本题获证.

设 $P_3(x_3, y_3, z_3)$ 是曲面 (3) 上任意一点, 并记 $\vec{r}_3 = \{a, b, c\}$. 由于曲面 (3) 在 P_3 点的法向量为

$$\vec{n}_3 = \left\{ \frac{\partial z}{\partial x} \Big|_{P_3}, \frac{\partial z}{\partial y} \Big|_{P_3}, -1 \right\}, \text{ 故由方程}$$

$$(cy - bz) \frac{\partial z}{\partial x} + (az - cx) \frac{\partial z}{\partial y} - (bx - ay) = 0$$

知

$$\vec{n}_3 \perp (\vec{P}_3 \times \vec{r}_3),$$

其中 $\vec{P}_3 = \{x_3, y_3, z_3\}$.

设由原点到 P_3 的距离为 d , 即

$$x_3^2 + y_3^2 + z_3^2 = d^2.$$

考虑平面

$$\Pi: ax + by + cz = d$$

和过点 P_3 的球面

$$S: x^2 + y^2 + z^2 = d^2,$$

并设平面 Π 与球面 S 的交线为 C , 则

1° 由点 P_3 在曲面 (3) 上可知

$$ax_3 + by_3 + cz_3 = \Phi(x_3^2 + y_3^2 + z_3^2),$$

即

$$d = \Phi(d^2).$$

这表明曲线 C 上的点的坐标皆满足方程 (3), 即曲线 C 位于曲面 (3) 上.

2°由 Π 为平面, S 为球面知交线 C 为一圆周曲线.

3°圆 C 的圆心 Q 即为由原点到平面 Π 的垂足, 故 Q 点位于过原点且与平面 Π 垂直的直线 l 上.

综上所述, 可见曲面(3)是以直线

$$l: \quad \frac{x}{a} = \frac{y}{b} = \frac{z}{c}$$

为旋转轴的旋转曲面.

3424. 函数 $z = z(x, y)$ 由方程

$$x^2 + y^2 + z^2 = yf\left(\frac{z}{y}\right)$$

所给出, 证明:

$$(x^2 - y^2 - z^2) \frac{\partial z}{\partial x} + 2xy \frac{\partial z}{\partial y} = 2xz.$$

证 由于

$$2x + 2z \frac{\partial z}{\partial x} = f'\left(\frac{z}{y}\right) \frac{\partial z}{\partial x},$$

故有

$$\frac{\partial z}{\partial x} = \frac{2x}{f'\left(\frac{z}{y}\right) - 2z}.$$

同法可求得

$$\frac{\partial z}{\partial y} = \frac{x^2 - y^2 + z^2 - zf'\left(\frac{z}{y}\right)}{2yz - yf'\left(\frac{z}{y}\right)}.$$

于是,

$$\begin{aligned}
& (x^2 - y^2 - z^2) \frac{\partial z}{\partial x} + 2xy \frac{\partial z}{\partial y} \\
&= \frac{2xy(y^2 + z^2 - x^2) + 2xy(x^2 - y^2 + z^2 - zf')}{y(2z - f')} \\
&= \frac{2xyz(2z - f')}{y(2z - f')} = 2xz,
\end{aligned}$$

本题获证.

3425. 函数 $z = z(x, y)$ 由方程

$$F(x + zy^{-1}, y + zx^{-1}) = 0$$

所给出, 证明:

$$x \frac{\partial z}{\partial x} + y \frac{\partial z}{\partial y} = z - xy.$$

证 由于

$$F'_1 \cdot \left(1 + \frac{1}{y} \frac{\partial z}{\partial x}\right) + F'_2 \cdot \left(\frac{x \frac{\partial z}{\partial x} - z}{x^2}\right) = 0,$$

$$F'_1 \cdot \left(\frac{y \frac{\partial z}{\partial y} - z}{y^2}\right) + F'_2 \cdot \left(1 + \frac{1}{x} \frac{\partial z}{\partial y}\right) = 0,$$

故有

$$\frac{\partial z}{\partial x} = \frac{yzF'_2 - x^2yF'_1}{x(xF'_1 + yF'_2)}, \quad \frac{\partial z}{\partial y} = \frac{xzF'_1 - xy^2F'_2}{y(xF'_1 + yF'_2)}.$$

于是,

$$x \frac{\partial z}{\partial x} + y \frac{\partial z}{\partial y} = \frac{yzF'_2 - x^2yF'_1 + xzF'_1 - xy^2F'_2}{xF'_1 + yF'_2}$$

$$= -\frac{(z-xy)(xF'_1+yF'_2)}{xF'_1+yF'_2} = z-xy,$$

本题获证.

3426. 证明: 由方程组

$$\left. \begin{aligned} x\cos\alpha + y\sin\alpha + \ln z &= f(\alpha), \\ -x\sin\alpha + y\cos\alpha &= f'(\alpha) \end{aligned} \right\}$$

[其中 $\alpha = \alpha(x, y)$ 为参变数及 $f(\alpha)$ 为任意可微分的函数]所定义的函数 $z = z(x, y)$ 满足方程式

$$\left(\frac{\partial z}{\partial x}\right)^2 + \left(\frac{\partial z}{\partial y}\right)^2 = z^2.$$

证 由 $x\cos\alpha + y\sin\alpha + \ln z = f(\alpha)$ 两端对 x 求偏导函数, 得

$$\begin{aligned} &\cos\alpha - x\sin\alpha \frac{\partial\alpha}{\partial x} + y\cos\alpha \frac{\partial\alpha}{\partial x} + \frac{1}{z} \frac{\partial z}{\partial x} \\ &= f'(\alpha) \frac{\partial\alpha}{\partial x}. \end{aligned}$$

由于 $-x\sin\alpha + y\cos\alpha = f'(\alpha)$, 代入上式, 即得

$$\cos\alpha + \frac{1}{z} \frac{\partial z}{\partial x} = 0 \quad \text{或} \quad \frac{\partial z}{\partial x} = -z\cos\alpha. \quad (1)$$

同法可求得

$$\frac{\partial z}{\partial y} = -z\sin\alpha. \quad (2)$$

将 (1), (2) 两式依次平方, 然后相加, 即得

$$\left(\frac{\partial z}{\partial x}\right)^2 + \left(\frac{\partial z}{\partial y}\right)^2 = z^2,$$

本题获证.

3427. 证明: 由方程组

$$\left. \begin{aligned} z &= ax + \frac{y}{a} + f(a), \\ 0 &= x - \frac{y}{a^2} + f'(a) \end{aligned} \right\}$$

所给出的函数 $z = z(x, y)$ 满足方程

$$\frac{\partial z}{\partial x} \frac{\partial z}{\partial y} = 1.$$

证 由于

$$\begin{aligned} dz &= a dx + \frac{1}{a} dy + \left[x - \frac{y}{a^2} + f'(a) \right] da \\ &= a dx + \frac{1}{a} dy, \end{aligned}$$

故有

$$\frac{\partial z}{\partial x} = a, \quad \frac{\partial z}{\partial y} = \frac{1}{a}.$$

于是,

$$\frac{\partial z}{\partial x} \frac{\partial z}{\partial y} = a \cdot \frac{1}{a} = 1,$$

本题获证.

3428. 证明: 由方程组

$$\left. \begin{aligned} [z - f(a)]^2 &= x^2(y^2 - a^2), \\ [z - f(a)] f'(a) &= ax^2 \end{aligned} \right\}$$

所定义的函数 $z = z(x, y)$ 满足方程

$$\frac{\partial z}{\partial x} \frac{\partial z}{\partial y} = xy.$$

证 $2[z - f(a)][dz - f'(a)d\alpha] = (y^2 - a^2)2xdx + x^2(2ydy - 2ada)$. 于是,

$$\begin{aligned} [z - f(a)]dz &= x(y^2 - a^2)dx + x^2ydy \\ &\quad - \{ax^2 - [z - f(a)]f'(a)\}d\alpha \\ &= x(y^2 - a^2)dx + x^2ydy, \end{aligned}$$

$$\frac{\partial z}{\partial x} = \frac{x(y^2 - a^2)}{z - f(a)}, \quad \frac{\partial z}{\partial y} = \frac{x^2y}{z - f(a)}.$$

从而得

$$\begin{aligned} \frac{\partial z}{\partial x} \frac{\partial z}{\partial y} &= \frac{x^3y(y^2 - a^2)}{[z - f(a)]^2} \\ &= xy \cdot \frac{x^2(y^2 - a^2)}{[z - f(a)]^2} = xy, \end{aligned}$$

本题获证.

3429. 证明: 由方程组

$$\left. \begin{aligned} z &= ax + y\varphi(a) + \psi(a), \\ 0 &= x + y\varphi'(a) + \psi'(a) \end{aligned} \right\}$$

所给出的函数 $z = z(x, y)$ 满足方程

$$\frac{\partial^2 z}{\partial x^2} \frac{\partial^2 z}{\partial y^2} - \left(\frac{\partial^2 z}{\partial x \partial y} \right)^2 = 0.$$

证 $\frac{\partial z}{\partial x} = a + x \frac{\partial a}{\partial x} + y\varphi'(a) \frac{\partial a}{\partial x} + \psi'(a) \frac{\partial a}{\partial x}$

$$= \alpha + [x + y\varphi'(\alpha) + \psi'(\alpha)] \frac{\partial \alpha}{\partial x} = \alpha,$$

$$\frac{\partial^2 z}{\partial x^2} = \frac{\partial \alpha}{\partial x}, \quad \frac{\partial^2 z}{\partial x \partial y} = \frac{\partial \alpha}{\partial y}.$$

$$\text{又 } \frac{\partial z}{\partial y} = x \frac{\partial \alpha}{\partial y} + \varphi(\alpha) + y\varphi'(\alpha) \frac{\partial \alpha}{\partial y}$$

$$+ \psi'(\alpha) \frac{\partial \alpha}{\partial y} = \varphi(\alpha),$$

$$\frac{\partial^2 z}{\partial y^2} = \varphi'(\alpha) \frac{\partial \alpha}{\partial y}, \quad \frac{\partial^2 z}{\partial y \partial x} = \varphi'(\alpha) \frac{\partial \alpha}{\partial x}.$$

$$\text{而 } \frac{\partial^2 z}{\partial x^2} \frac{\partial^2 z}{\partial y^2} - \left(\frac{\partial^2 z}{\partial x \partial y} \right)^2 = \frac{\partial \alpha}{\partial x} \frac{\partial \alpha}{\partial y} \varphi'(\alpha) - \left(\frac{\partial \alpha}{\partial y} \right)^2$$

$$= \frac{\partial \alpha}{\partial y} \left[\varphi'(\alpha) \frac{\partial \alpha}{\partial x} - \frac{\partial \alpha}{\partial y} \right],$$

由于 $\frac{\partial^2 z}{\partial x \partial y} = \frac{\partial^2 z}{\partial y \partial x}$, 故 $\frac{\partial \alpha}{\partial y} = \varphi'(\alpha) \frac{\partial \alpha}{\partial x}$. 于是,

$$\frac{\partial^2 z}{\partial x^2} \frac{\partial^2 z}{\partial y^2} - \left(\frac{\partial^2 z}{\partial x \partial y} \right)^2 = 0^*),$$

本题获证.

*) 此式也可由原方程组第二式两端分别对 x 和 y 求偏导函数而获得.

3430. 证明: 由方程

$$y = x\varphi(z) + \psi(z)$$

所定义的隐函数 $z = z(x, y)$ 满足方程

$$\left(\frac{\partial z}{\partial y}\right)^2 \frac{\partial^2 z}{\partial x^2} - 2 \frac{\partial z}{\partial x} \frac{\partial z}{\partial y} \frac{\partial^2 z}{\partial x \partial y} + \left(\frac{\partial z}{\partial x}\right)^2 \frac{\partial^2 z}{\partial y^2} = 0.$$

证 记 $\frac{\partial z}{\partial x} = p, \frac{\partial z}{\partial y} = q, \frac{\partial^2 z}{\partial x^2} = r, \frac{\partial^2 z}{\partial x \partial y} = s,$
 $\frac{\partial^2 z}{\partial y^2} = t.$

将所给方程两端分别对 x 和对 y 逐次求偏导数, 得

$$\begin{aligned} \varphi(z) + [x\varphi'(z) + \psi'(z)]p &= 0, \\ [x\varphi'(z) + \psi'(z)]q &= 1; \\ 2\varphi'(z)p + [x\varphi''(z) + \psi''(z)]p^2 + [x\varphi'(z) \\ &+ \psi'(z)]r = 0, \end{aligned} \quad (1)$$

$$\begin{aligned} \varphi'(z)q + [x\varphi''(z) + \psi''(z)]pq + [x\varphi'(z) \\ + \psi'(z)]s = 0, \end{aligned} \quad (2)$$

$$[x\varphi''(z) + \psi''(z)]q^2 + [x\varphi'(z) + \psi'(z)]t = 0. \quad (3)$$

将 (1), (2), (3) 三式依次乘以 q^2 , $(-2pq)$ 及 p^2 , 然后相加, 并注意到 $x\varphi'(z) + \psi'(z) \neq 0$ (因为 $[x\varphi'(z) + \psi'(z)]q = 1$), 即得

$$rq^2 - 2pqs + tp^2 = 0,$$

此即所要证明的.

§4. 变量代换

1° 在含有导函数的式子中的变量代换. 设于式

$$A = \Phi(x, y, y'_x, y''_{xx}, \dots)$$

中需要把 x, y 换为新的变量: t (自变量) 及 u (函数), 这些变量由方程

$$x = f(t, u), \quad y = g(t, u) \quad (1)$$

与原来的变量 x 和 y 联系起来.

把方程式 (1) 微分, 便有:

$$y'_x = \frac{\frac{\partial g}{\partial t} + \frac{\partial g}{\partial u} u'_t}{\frac{\partial f}{\partial t} + \frac{\partial f}{\partial u} u'_t}.$$

同样地可表示出高阶的导函数 y''_{xx} , ... 因此我们得:

$$A = \Phi_1(t, u, u'_t, u''_{tt}, \dots).$$

2° 在含有偏导函数的式子中自变量的代换. 若于下式中

$$B = F\left(x, y, z, \frac{\partial z}{\partial x}, \frac{\partial z}{\partial y}, \frac{\partial^2 z}{\partial x^2}, \frac{\partial^2 z}{\partial x \partial y}, \frac{\partial^2 z}{\partial y^2}, \dots\right)$$

令

$$x = f(u, v), \quad y = g(u, v), \quad (2)$$

其中 u 和 v 为新的自变量, 则挨次的偏导函数 $\frac{\partial z}{\partial x}, \frac{\partial z}{\partial y}, \dots$

由下列方程所确定:

$$\frac{\partial z}{\partial u} = \frac{\partial z}{\partial x} \frac{\partial f}{\partial u} + \frac{\partial z}{\partial y} \frac{\partial g}{\partial u},$$

$$\frac{\partial z}{\partial v} = \frac{\partial z}{\partial x} \frac{\partial f}{\partial v} + \frac{\partial z}{\partial y} \frac{\partial g}{\partial v},$$

等等。

3° 在含有偏导函数的式子中自变量和函数的代换。在一般的情况下，设有方程

$$x = f(u, v, w), y = g(u, v, w), z = h(u, v, w), \quad (3)$$

其中 u, v 为新的自变量及 $w = w(u, v)$ 为新的函数，则对于偏

导函数 $\frac{\partial z}{\partial x}, \frac{\partial z}{\partial y}, \dots$ 得到这样的方程：

$$\begin{aligned} & \frac{\partial z}{\partial x} \left(\frac{\partial f}{\partial u} + \frac{\partial f}{\partial w} \frac{\partial w}{\partial u} \right) + \frac{\partial z}{\partial y} \left(\frac{\partial g}{\partial u} + \frac{\partial g}{\partial w} \frac{\partial w}{\partial u} \right) \\ &= \frac{\partial h}{\partial u} + \frac{\partial h}{\partial w} \frac{\partial w}{\partial u}, \end{aligned}$$

$$\begin{aligned} & \frac{\partial z}{\partial x} \left(\frac{\partial f}{\partial v} + \frac{\partial f}{\partial w} \frac{\partial w}{\partial v} \right) + \frac{\partial z}{\partial y} \left(\frac{\partial g}{\partial v} + \frac{\partial g}{\partial w} \frac{\partial w}{\partial v} \right) \\ &= \frac{\partial h}{\partial v} + \frac{\partial h}{\partial w} \frac{\partial w}{\partial v}, \end{aligned}$$

等等。

在某些情况下，使用全微分法进行变量代换是方便的。

3431. 把 y 看作新的自变量，变换方程

$$y' y'' - 3y''^2 = x.$$

解 函数 $y = y(x)$ 的各阶导函数 y', y'', y''', \dots 与其反函数 $x = x(y)$ 的各阶导函数 x', x'', x''', \dots 之间有下述关系。

$$y' = \frac{1}{x'}, \quad \text{公式 1}$$

$$\begin{aligned}
 y'' &= (y')' = \left(\frac{1}{x'}\right)' \cdot y'_x = -\frac{x''}{x'^2} \cdot \frac{1}{x} \\
 &= -\frac{x''}{(x')^3}, \quad \text{公式 2}
 \end{aligned}$$

$$\begin{aligned}
 y''' &= (y'')' = -\left[\frac{x''}{(x')^3}\right]' \cdot y'_x \\
 &= \frac{3(x'')^2 - x'x'''}{(x')^5}. \quad \text{公式 3}
 \end{aligned}$$

以公式 1、2、3 代入所给方程，化简整理即得

$$x''' + x(x')^5 = 0.$$

3432. 用同样的方法变换方程

$$(y')^2 y^{(4)} - 10y' y'' y''' + 15(y'')^3 = 0.$$

解 解法一

由公式 3 可得

$$\begin{aligned}
 y^{(4)} &= (y''')' = \left[\frac{3(x'')^2 - x'x'''}{(x')^5}\right]' y'_x \\
 &= \frac{6x'x''x''' - (x')^2 x^{(4)} - x'x''x'' - 5[3(x'')^2 - x'x''']x''}{(x')^6} \\
 &\cdot \frac{1}{x'} = \frac{10x'x''x''' - (x')^2 x^{(4)} - 15(x'')^3}{(x')^7}. \quad \text{公式 4}
 \end{aligned}$$

以公式 1、2、3、4 代入所给方程，化简整理即得

$$x^{(4)} = 0.$$

解法二

由公式 4 可看出

$$x^{(4)} = \frac{10y' y'' y''' - (y')^2 y^{(4)} - 15(y'')^3}{(y')^7}.$$

因此，所给方程可改写为

$$-x^{(4)}(y')^7 = 0.$$

由于 $y' \neq 0$ ，故得

$$x^{(4)} = 0.$$

3433. 取 x 作函数， $t = xy$ 作自变量，变换方程

$$y'' + \frac{2}{x} y' + y = 0.$$

解 将 $t = t(x)$ 看作 x 的函数，对 $t = xy$ 两端分别求 x 的一阶、二阶导数，得

$$\frac{dt}{dx} = y + xy', \quad (1)$$

$$\frac{d^2t}{dx^2} = 2y' + xy''. \quad (2)$$

由于 $\frac{dx}{dt} = \frac{1}{\frac{dt}{dx}}$ ，故由 (1) 式得

$$y' = \frac{1 - y \frac{dx}{dt}}{x \frac{dx}{dt}}. \quad (3)$$

由公式 2 及 (2) 式可得

$$-\frac{\frac{d^2x}{dt^2}}{\left(\frac{dx}{dt}\right)^3} = 2y' + xy'',$$

$$y'' = -\frac{\frac{d^2x}{dt^2}}{x\left(\frac{dx}{dt}\right)^3} - \frac{2y'}{x}. \quad (4)$$

將(4)式代入所給方程, 得

$$-\frac{d^2x}{dt^2} + xy\left(\frac{dx}{dt}\right)^3 = 0 \text{ 或 } \frac{d^2x}{dt^2} - t\left(\frac{dx}{dt}\right)^3 = 0.$$

引入新變量, 變換下列常微分方程:

3434. $x^2y'' + xy' + y = 0$, 若 $x = e^t$.

解 當函數 y 不變, 只作自變量的代換 $x = x(t)$ 時,

注意到對 $\frac{dt}{dx}$, $\frac{d^2t}{dx^2}$ 運用公式 1 及 2, 即得

$$y' = \frac{dy}{dt} \frac{dt}{dx} = \frac{\frac{dy}{dt}}{\frac{dx}{dt}}, \quad \text{公式 5}$$

$$\begin{aligned} y'' &= \frac{d}{dx} \left(\frac{dy}{dt} \frac{dt}{dx} \right) = \frac{d^2y}{dt^2} \left(\frac{dt}{dx} \right)^2 + \frac{dy}{dt} \frac{d^2t}{dx^2} \\ &= \frac{\frac{d^2y}{dt^2} \frac{dx}{dt} - \frac{dy}{dt} \frac{d^2x}{dt^2}}{\left(\frac{dx}{dt} \right)^3}. \end{aligned} \quad \text{公式 6}$$

在本题中, $x = e^t$, 故有

$$\frac{dx}{dt} = e^t = x, \quad \frac{d^2x}{dt^2} = e^t = x,$$

从而有

$$\begin{aligned} y' &= \frac{dy}{dx}, \\ y'' &= \frac{x \frac{d^2y}{dt^2} - x \frac{dy}{dt}}{x^3} = \frac{1}{x^2} \left(\frac{d^2y}{dt^2} - \frac{dy}{dt} \right). \end{aligned}$$

將 y' 及 y'' 代入所給方程, 即得

$$\frac{d^2 y}{dt^2} + y = 0.$$

3435. $y'' = \frac{6y}{x^3}$, 若 $t = \ln|x|$.

解 应用复合函数求导公式, 有

$$y' = \frac{dy}{dt} \frac{dt}{dx} = \frac{1}{x} \frac{dy}{dt},$$

$$\begin{aligned} y'' &= \frac{d}{dx} \left(\frac{1}{x} \frac{dy}{dt} \right) = \frac{1}{x^2} \left(x \frac{d^2 y}{dt^2} \frac{dt}{dx} - \frac{dy}{dt} \right) \\ &= \frac{\frac{d^2 y}{dt^2} - \frac{dy}{dt}}{x^2}, \end{aligned}$$

$$\begin{aligned} y''' &= \frac{1}{x^4} \left[x^2 \left(\frac{d^3 y}{dt^3} - \frac{d^2 y}{dt^2} \right) \frac{dt}{dx} - 2x \left(\frac{d^2 y}{dt^2} - \frac{dy}{dt} \right) \right] \\ &= \frac{1}{x^3} \left(\frac{d^3 y}{dt^3} - 3 \frac{d^2 y}{dt^2} + 2 \frac{dy}{dt} \right). \end{aligned}$$

将 y'' 代入所给方程, 即得

$$\frac{d^3 y}{dt^3} - 3 \frac{d^2 y}{dt^2} + 2 \frac{dy}{dt} - 6y = 0.$$

3436. $(1-x^2)y'' - xy' + n^2 y = 0$, 若 $x = \cos t$.

解 注意到 $\frac{dx}{dt} = -\sin t$, $\frac{d^2 x}{dt^2} = -\cos t$, 用公式 5 及 6, 就有

$$y' = -\frac{\frac{dy}{dt}}{\sin t}, \quad y'' = \frac{-\sin t \frac{d^2 y}{dt^2} + \cos t \frac{dy}{dt}}{-\sin^3 t}.$$

将 y', y'' 及 x 代入所给方程, 即得

$$\frac{d^2 y}{dt^2} + n^2 y = 0.$$

3437. $y'' + y' \operatorname{th} x + \frac{m^2}{\operatorname{ch}^2 x} y = 0$, 若 $x = \ln \operatorname{tg} \frac{t}{2}$.

解 仍用公式 5 及 6, 注意到

$$\frac{dx}{dt} = \frac{1}{\sin t}, \quad \frac{d^2 x}{dt^2} = -\frac{\cos t}{\sin^2 t},$$

$$\operatorname{ch} x = \frac{1}{\sin t}, \quad \operatorname{th} x = -\cos t,$$

就有

$$y' = \sin t \frac{dy}{dt}, \quad y'' = \sin^2 t \frac{d^2 y}{dt^2} + \sin t \cos t \frac{dy}{dt}.$$

将 $y', y'', \operatorname{ch} x$ 及 $\operatorname{th} x$ 代入所给方程, 即得

$$\frac{d^2 y}{dt^2} + m^2 y = 0.$$

3438. $y'' + p(x)y' + q(x)y = 0$, 令 $y = ue^{-\frac{1}{2} \int_{x_0}^x p(\xi) d\xi}$.

解 $y' = \frac{du}{dx} e^{-\frac{1}{2} \int_{x_0}^x p(\xi) d\xi} - \frac{1}{2} u \cdot p(x) e^{-\frac{1}{2} \int_{x_0}^x p(\xi) d\xi}$

$$y'' = \frac{d^2 u}{dx^2} e^{-\frac{1}{2} \int_{x_0}^x p(\xi) d\xi} - p(x) \frac{du}{dx} e^{-\frac{1}{2} \int_{x_0}^x p(\xi) d\xi}$$

$$+ \frac{1}{4} u \cdot p^2(x) e^{-\frac{1}{2} \int_{x_0}^x p(\xi) d\xi}$$

$$-\frac{1}{2}u \cdot p'(x)e^{-\frac{1}{2}\int_{x_0}^x p(t) dt}.$$

将 y', y'' 代入所给方程, 化简整理即得

$$\frac{d^2u}{dx^2} + \left[q(x) - \frac{1}{4}p^2(x) - \frac{1}{2}p'(x) \right] u = 0.$$

3439. $x^4 y'' + x y y' - 2y^2 = 0$. 令

$$x = e^t, \quad y = u e^{2t},$$

其中 $u = u(t)$.

$$\text{解 } y' = \frac{\frac{dy}{dt}}{\frac{dx}{dt}} = \frac{e^{2t}(2u + u')}{e^t} = e^t(2u + u'),$$

$$y'' = \frac{\frac{dy'}{dt}}{\frac{dx}{dt}} = \frac{e^t(u'' + 3u' + 2u)}{e^t} = u'' + 3u' + 2u,$$

其中 u' 及 u'' 表示 u 对 t 的一阶及二阶导函数, 以下各题类似, 不再说明.

将 y', y'' 及 x, y 代入所给方程, 化简整理即得

$$u'' + (u + 3)u' + 2u = 0.$$

3440. $(1+x^2)^2 y'' = y$, 若

$$x = \operatorname{tg} t, \quad y = \frac{u}{\cos t},$$

其中 $u = u(t)$.

$$\text{解 } y' = \frac{\frac{u' \cos t + u \sin t}{\cos^2 t}}{\frac{1}{\cos^2 t}} = u' \cos t + u \sin t,$$

$$y'' = \frac{u'' \cos t + u \cos t}{\frac{1}{\cos^2 t}} = (u'' + u) \cos^3 t.$$

将 y' , y'' 及 x, y 代入所给方程, 化简整理即得

$$u'' = 0.$$

3441. $(1-x^2)^2 y'' = -y$, 若

$$x = tht, \quad y = \frac{u}{cht},$$

其中 $u = u(t)$.

$$\text{解 } y' = \frac{\frac{u'cht - usht}{ch^2t}}{\frac{1}{ch^2t}} = u'cht - usht,$$

$$y'' = \frac{u''cht - ucht}{\frac{1}{ch^2t}} = (u'' - u)ch^3t.$$

将 y'' 及 x, y 代入所给方程, 化简整理即得

$$u'' = 0.$$

3442. $y'' + (x+y)(1+y')^3 = 0$, 若 $x = u+t$, $y = u-t$,

其中 $u = u(t)$.

$$\text{解 } y' = \frac{u' - 1}{u' + 1},$$

$$y'' = \frac{\frac{u''(u'+1) - u''(u'-1)}{(u'+1)^2}}{u'+1} = \frac{2u''}{(u'+1)^3}.$$

将 y' , y'' 及 x, y 代入所给方程, 化简整理即得

$$u'' + 8u(u')^3 = 0.$$

3443. $y''' - x^3 y'' + x y' - y = 0$, 若 $x = \frac{1}{t}$ 及 $y = \frac{u}{t}$, 其中 $u = u(t)$.

$$\text{解 } y' = \frac{\frac{u't - u}{t^2}}{-\frac{1}{t^2}} = u - tu',$$

$$y'' = \frac{-tu''}{-\frac{1}{t^2}} = t^3 u'',$$

$$y''' = \frac{3t^2 u'' + t^3 u'''}{-\frac{1}{t^2}} = -t^4 (3u'' + tu''').$$

将 y' , y'' , y''' 及 x, y 代入所给方程, 化简整理即得

$$t^5 u + (3t^4 + 1)u'' + u' = 0.$$

3444. 假定

$$u = \frac{y}{x-b}, \quad t = \ln \left| \frac{x-a}{x-b} \right|,$$

并取 u 作为变量 t 的函数, 以变换斯托克斯方程

$$y'' = \frac{Ay}{(x-a)^2(x-b)^2}.$$

解 由于 $t = \ln|x-a| - \ln|x-b|$, 故有

$$\frac{dt}{dx} = \frac{1}{x-a} - \frac{1}{x-b} = \frac{a-b}{(x-a)(x-b)}$$

$$\text{或 } \frac{dx}{dt} = \frac{(x-a)(x-b)}{a-b}. \quad (1)$$

又因 $u = \frac{y}{x-b}$, 故 $y = u(x-b)$,

$$\begin{aligned} y' &= (x-b) \frac{du}{dx} + u = \frac{\frac{du}{dt}}{\frac{dx}{dt}} (x-b) + u \\ &= \frac{(a-b)u'}{x-a} + u, \end{aligned} \quad (2)$$

$$\begin{aligned} y'' &= \frac{\frac{dy'}{dt}}{\frac{dx}{dt}} = \left[\frac{(a-b)u''}{x-a} + u' - \frac{(a-b)u'}{(x-a)^2} \frac{dx}{dt} \right] \\ &\cdot \frac{b-a}{(x-a)(x-b)} = \frac{(a-b)^2(u'' - u')}{(x-a)^2(x-b)}. \end{aligned} \quad (3)$$

将(3)式代入所给方程, 即得

$$u'' - u' = \frac{Au}{(a-b)^2} \quad (a \neq b).$$

3445. 证明: 若方程

$$\frac{d^2 y}{dx^2} + p(x) \frac{dy}{dx} + q(x)y = 0,$$

由代换 $x = \varphi(\xi)$ 变换为方程

$$\frac{d^2 y}{d\xi^2} + P(\xi) \frac{dy}{d\xi} + Q(\xi)y = 0,$$

则

$$\begin{aligned} & [2P(\xi)Q(\xi) + Q'(\xi)][Q(\xi)]^{-\frac{3}{2}} \\ &= [2p(x)q(x) + q'(x)][q(x)]^{-\frac{3}{2}}. \end{aligned}$$

证 $\frac{dx}{d\xi} = \varphi'(\xi)$, $\frac{d^2x}{d\xi^2} = \varphi''(\xi)$. 由公式 5 及 6, 得

$$\begin{aligned} \frac{dy}{dx} &= \frac{\frac{dy}{d\xi}}{\varphi'(\xi)}, \quad \frac{d^2y}{dx^2} = \frac{1}{(\varphi'(\xi))^2} \frac{d^2y}{d\xi^2} \\ &\quad - \frac{\varphi''(\xi)}{[\varphi'(\xi)]^3} \frac{dy}{d\xi}. \end{aligned}$$

代入原方程, 两端同乘 $[\varphi'(\xi)]^2$, 即得

$$\begin{aligned} & \frac{d^2y}{d\xi^2} + \left\{ p[\varphi(\xi)]\varphi'(\xi) - \frac{\varphi''(\xi)}{\varphi'(\xi)} \right\} \frac{dy}{d\xi} \\ & + q[\varphi(\xi)][\varphi'(\xi)]^2 y = 0. \end{aligned}$$

于是,

$$P(\xi) = p\varphi' - \frac{\varphi''}{\varphi'}, \quad Q(\xi) = q \cdot (\varphi')^2;$$

$$Q'(\xi) = q' \cdot (\varphi')^2 + 2q\varphi'\varphi''.$$

从而得知

$$\begin{aligned} & [2P(\xi)Q(\xi) + Q'(\xi)][Q(\xi)]^{-\frac{3}{2}} \\ &= \left\{ 2\left(p\varphi' - \frac{\varphi''}{\varphi'} \right) q \cdot (\varphi')^2 + q' \cdot (\varphi')^2 \right. \\ & \quad \left. + 2q\varphi'\varphi'' \right\} [q \cdot (\varphi')^2]^{-\frac{3}{2}} \end{aligned}$$

$$\begin{aligned}
&= \{2pq \cdot (\varphi')^3 + q' \cdot (\varphi')^3\} q^{-\frac{3}{2}} \cdot (\varphi')^{-3}, \\
&= (2p(x)q(x) + q'(x)) [q(x)]^{-\frac{3}{2}},
\end{aligned}$$

本题获证.

3446. 在方程

$$\Phi(y, y', y'') = 0$$

(其中 Φ 为变量 y, y', y'' 的齐次函数) 中令 $y = e^{\int_{x_0}^x u dx}$.

$$\text{解 } y' = u \cdot e^{\int_{x_0}^x u dx}, \quad y'' = (u' + u^2) e^{\int_{x_0}^x u dx}.$$

代入方程 $\Phi(y, y', y'') = 0$, 由于 Φ 关于 y, y', y'' 是齐次的, 因此, 各项含有的因式 $e^{\int_{x_0}^x u dx}$ 均可约去, 最后得

$$\Phi(1, u, u' + u^2) = 0.$$

3447. 在方程

$$F(x^2 y'', xy', y) = 0$$

(其中 F 为其变量的齐次函数) 中令 $u = x \cdot \frac{y'}{y}$.

$$\begin{aligned}
\text{解 } y' &= \frac{yu}{x}, \quad y'' = \frac{x(u'y + y'u) - yu}{x^2} \\
&= \frac{y[xu' + (u^2 - u)]}{x^2}. \text{ 于是,}
\end{aligned}$$

$$xy' = uy, \quad x^2 y'' = y[xu' + (u^2 - u)].$$

由于 F 为其变量的齐次函数, 因此, 各项含有的因子 y 均可约去, 最后得

$$F(xu' + u^2 - u, u, 1) = 0.$$

3448. 证明: 经射影变换

$$x = \frac{a_1\xi + b_1\eta + c_1}{a\xi + b\eta + c}, \quad y = \frac{a_2\xi + b_2\eta + c_2}{a\xi + b\eta + c},$$

方程式

$$y''(1+y'^2) - 3y'y''^2 = 0$$

不变其形状.

证 本题似有误. 事实上, 作压缩变换

$$x = \xi, \quad y = a\eta \quad (a \neq 0)$$

(它是射影变换的特例), 则原方程变为

$$a\eta''(1+a\eta'^2) - 3a^3\eta'\eta''^2 = 0,$$

显然形式已改变.

3449. 证明:

$$S[x(t)] = \frac{x''(t)}{x'(t)} - \frac{3}{2} \left[\frac{x''(t)}{x'(t)} \right]^2$$

对于线性分式变换

$$y = \frac{ax(t) + b}{cx(t) + d} \quad (ad - bc \neq 0),$$

其值不变.

证 已知的变换

$$\begin{aligned} y &= \frac{ax+b}{cx+d} = \frac{a\left(x + \frac{d}{c}\right) + \left(b - \frac{ad}{c}\right)}{cx+d} \\ &= \frac{a}{c} + \frac{bc-ad}{c(cx+d)} \end{aligned}$$

可由下述变换所构成:

$$y = \alpha + \beta y_2, \quad y_2 = \frac{1}{y_1}, \quad y_1 = cx + d.$$

只要证明在上述各种变换下 S 的值不变即可。

1° 令 $y_1 = cx + d$, 则 $y_1'(t) = cx'(t)$, $y_1''(t) = cx''(t)$, $y_1'''(t) = cx'''(t)$. 于是,

$$\begin{aligned} S[y_1(t)] &= \frac{y_1'''(t)}{y_1'(t)} - \frac{3}{2} \left[\frac{y_1''(t)}{y_1'(t)} \right]^2 \\ &= \frac{x'''(t)}{x'(t)} - \frac{3}{2} \left[\frac{x''(t)}{x'(t)} \right]^2 = S[x(t)]; \end{aligned}$$

$$2^\circ \text{ 令 } y_2 = \frac{1}{y_1}, \text{ 则 } y_2'(t) = -\frac{y_1'}{y_1^2},$$

$$y_2''(t) = -\frac{y_1 y_1'' - 2y_1'^2}{y_1^3},$$

$$y_2'''(t) = -\frac{y_1''' y_1^2 - 6y_1'' y_1' y_1 + 6y_1'^3}{y_1^4}. \text{ 于是,}$$

$$\begin{aligned} S[y_2(t)] &= \frac{y_2'''(t)}{y_2'(t)} - \frac{3}{2} \left[\frac{y_2''(t)}{y_2'(t)} \right]^2 \\ &= \frac{\frac{y_1''' y_1^2 - 6y_1'' y_1' y_1 + 6y_1'^3}{y_1^4}}{-\frac{y_1'}{y_1^2}} - \frac{3}{2} \left[\frac{\frac{y_1 y_1'' - 2y_1'^2}{y_1^3}}{-\frac{y_1'}{y_1^2}} \right]^2 \\ &= \frac{y_1'''}{y_1'} - \frac{6y_1''}{y_1} + \frac{6y_1'^2}{y_1^2} - \frac{3}{2} \left(\frac{y_1''}{y_1'} - \frac{2y_1'}{y_1} \right)^2 \\ &= \frac{y_1'''}{y_1'} - \frac{3}{2} \left(\frac{y_1''}{y_1'} \right)^2 = S[y_1(t)] = S[x(t)]; \end{aligned}$$

3° 由1°及2°即知

$$\begin{aligned}
 S(y(t)) &= S(a + \beta y_2) = \frac{(a + \beta y_2)''''}{(a + \beta y_2)'} \\
 &\quad - \frac{3}{2} \left\{ \frac{(a + \beta y_2)''}{(a + \beta y_2)'} \right\}^2 \\
 &= \frac{y_2''''}{y_2'} - \frac{3}{2} \left(\frac{y_2''}{y_2'} \right)^2 = S(y_2(t)) = S(x(t)). \text{证毕.}
 \end{aligned}$$

将下列方程式改变为极坐标 r 与 φ 所表示的方程, 即令 $x = r \cos \varphi$, $y = r \sin \varphi$:

3450. $\frac{dy}{dx} = \frac{x+y}{x-y}$.

解 当 $x = r \cos \varphi$, $y = r \sin \varphi$ 时,

$$\frac{dx}{d\varphi} = \cos \varphi \frac{dr}{d\varphi} - r \sin \varphi, \quad \frac{dy}{d\varphi} = \sin \varphi \frac{dr}{d\varphi} + r \cos \varphi,$$

$$\frac{d^2x}{d\varphi^2} = \cos \varphi \frac{d^2r}{d\varphi^2} - 2 \sin \varphi \frac{dr}{d\varphi} - r \cos \varphi,$$

$$\frac{d^2y}{d\varphi^2} = \sin \varphi \frac{d^2r}{d\varphi^2} + 2 \cos \varphi \frac{dr}{d\varphi} - r \sin \varphi.$$

由公式 5 及 6, 即得

$$\frac{dy}{dx} = \frac{\frac{dy}{d\varphi}}{\frac{dx}{d\varphi}} = \frac{\sin \varphi \frac{dr}{d\varphi} + r \cos \varphi}{\cos \varphi \frac{dr}{d\varphi} - r \sin \varphi}, \quad \text{公式 7}$$

$$\frac{d^2y}{dx^2} = \frac{\frac{d^2y}{d\varphi^2} \frac{dx}{d\varphi} - \frac{dy}{d\varphi} \frac{d^2x}{d\varphi^2}}{\left(\frac{dx}{d\varphi} \right)^3}$$

$$= \frac{r^2 + 2 \left(\frac{dr}{d\varphi} \right)^2 - r \frac{d^2r}{d\varphi^2}}{\left(\cos\varphi \frac{dr}{d\varphi} - r \sin\varphi \right)^3}. \quad \text{公式 8}$$

将公式 7 及 x, y 代入所给方程, 化简整理即得

$$\frac{dr}{d\varphi} = r \text{ 或 } r' = r.$$

以下各题, $\frac{dr}{d\varphi}$ 及 $\frac{d^2r}{d\varphi^2}$ 均简记为 r' 及 r'' .

3451. $(xy' - y)^2 = 2xy(1 + y'^2).$

$$\begin{aligned} \text{解 } xy' - y &= r \cos\varphi \cdot \frac{r' \sin\varphi + r \cos\varphi}{r' \cos\varphi - r \sin\varphi} - r \sin\varphi \\ &= \frac{r(r' \sin\varphi \cos\varphi + r \cos^2\varphi - r' \sin\varphi \cos\varphi + r \sin^2\varphi)}{r' \cos\varphi - r \sin\varphi} \\ &= \frac{r^2}{r' \cos\varphi - r \sin\varphi}, \\ 1 + y'^2 &= 1 + \left(\frac{r' \sin\varphi + r \cos\varphi}{r' \cos\varphi - r \sin\varphi} \right)^2 \\ &= \frac{r'^2 + r^2}{(r' \cos\varphi - r \sin\varphi)^2}. \end{aligned}$$

将 $xy' - y, 1 + y'^2$ 及 x, y 代入所给方程, 化简整理即得

$$r'^2 = \frac{1 - \sin 2\varphi}{\sin 2\varphi} r^2.$$

$$3452. (x^2 + y^2)^2 y'' = (x + yy')^3.$$

$$\text{解 } x + yy' = r \cos \varphi + r \sin \varphi \cdot \frac{r' \sin \varphi + r \cos \varphi}{r' \cos \varphi - r \sin \varphi}$$

$$= \frac{rr' \cos^2 \varphi - r^2 \sin \varphi \cos \varphi + rr' \sin^2 \varphi + r^2 \sin \varphi \cos \varphi}{r' \cos \varphi - r \sin \varphi}$$

$$= \frac{rr'}{r' \cos \varphi - r \sin \varphi}.$$

将公式 8, $x + yy'$ 及 x, y 代入所给方程, 化简整理即得

$$r(r^2 + 2r'^2 - rr'') = r'^3.$$

3453. 把式子

$$\frac{x + yy'}{xy' - y}$$

变换为极坐标的式子.

解 将 3451 题中 $xy' - y$ 的结果及 3452 题中 $x + yy'$ 的结果代入所给式子, 即得

$$\frac{x + yy'}{xy' - y} = \frac{r'}{r}.$$

3454. 把平面曲线的曲率

$$K = \frac{|y''|}{(1 + y'^2)^{\frac{3}{2}}}$$

用极坐标 r 及 φ 表示之.

解 将 3451 题中 $1 + y'^2$ 的结果及公式 8 代入, 化简整理即得

$$K = \frac{|r^2 + 2r'{}^2 - rr''|}{(r^2 + r'{}^2)^{\frac{3}{2}}}$$

3455. 将方程组

$$\frac{dx}{dt} = y + kx(x^2 + y^2),$$

$$\frac{dy}{dt} = -x + ky(x^2 + y^2)$$

改变为极坐标方程.

解 由原方程组得

$$\cos\varphi \frac{dr}{dt} - r\sin\varphi \frac{d\varphi}{dt} = r\sin\varphi + kr^3\cos\varphi,$$

$$\sin\varphi \frac{dr}{dt} + r\cos\varphi \frac{d\varphi}{dt} = -r\cos\varphi + kr^3\sin\varphi.$$

联立解之, 即得

$$\frac{dr}{dt} = \frac{1}{r} [r\cos\varphi \cdot (r\sin\varphi + kr^3\cos\varphi)$$

$$- (-r\sin\varphi)(-r\cos\varphi + kr^3\sin\varphi)] = kr^3,$$

$$\frac{d\varphi}{dt} = \frac{1}{r} [\cos\varphi \cdot (-r\cos\varphi + kr^3\sin\varphi)$$

$$- \sin\varphi \cdot (r\sin\varphi + kr^3\cos\varphi)] = -1,$$

即原方程组转化为

$$\begin{cases} \frac{dr}{dt} = kr^2, \\ \frac{d\varphi}{dt} = -1. \end{cases}$$

3456. 引用新函数 $r = \sqrt{x^2 + y^2}$, $\varphi = \text{arc tg} \frac{y}{x}$, 变换式子

$$W = x \frac{d^2 y}{dt^2} - y \frac{d^2 x}{dt^2}.$$

解 由 $r = \sqrt{x^2 + y^2}$ 两端微分, 得

$$dr = \frac{xdx + ydy}{\sqrt{x^2 + y^2}} = \frac{x}{r} dx + \frac{y}{r} dy$$

或

$$rdr = xdx + ydy. \quad (1)$$

由 $\varphi = \text{arc tg} \frac{y}{x}$ 两端微分, 得

$$d\varphi = \frac{xdy - ydx}{x^2 + y^2} = \frac{x}{r^2} dy - \frac{y}{r^2} dx$$

或

$$r^2 d\varphi = xdy - ydx. \quad (2)$$

于是, 由(1)及(2)可得

$$\begin{aligned} xrd r - yr^2 d\varphi &= (x^2 dx + xydy) - (xydy - y^2 dx) \\ &= (x^2 + y^2) dx = r^2 dx, \end{aligned}$$

$$dx = \frac{x}{r} dr - y d\varphi. \quad (3)$$

同理可得

$$dy = \frac{y}{r} dr + x d\varphi. \quad (4)$$

从而由(3)及(4), 得

$$\begin{aligned} xd^2y - yd^2x &= x\left(\frac{y}{r} d^2r - \frac{y}{r^2} dr^2\right) \\ &+ \frac{1}{r} drdy + dx d\varphi + x d^2\varphi \\ &- y\left(\frac{x}{r} d^2r - \frac{x}{r^2} dr^2 + \frac{1}{r} dxdr - dyd\varphi - yd^2\varphi\right) \\ &= \frac{dr}{r}(xdy - ydx) + (xdx + ydy)d\varphi \\ &+ (x^2 + y^2)d^2\varphi \\ &= \frac{dr}{r}(r^2 d\varphi) + (rdr)d\varphi + r^2 d^2\varphi \\ &= 2rdrd\varphi + r^2 d^2\varphi, \end{aligned}$$

于是,

$$\begin{aligned} W &= x \frac{d^2y}{dt^2} - y \frac{d^2x}{dt^2} = 2r \frac{dr}{dt} \frac{d\varphi}{dt} + r^2 \frac{d^2\varphi}{dt^2} \\ &= \frac{d}{dt} \left(r^2 \frac{d\varphi}{dt} \right). \end{aligned}$$

3457. 在勒襄德变换中曲线 $y = y(x)$ 的每一点 (x, y) 对应于点 (X, Y) , 其中

$$X = y', \quad Y = xy' - y.$$

求 Y' , Y'' 及 Y''' .

$$\text{解 } Y' = \frac{dY}{dX} = \frac{dY}{dx} \cdot \frac{dx}{dX} = \frac{xy''}{\frac{dX}{dx}} = \frac{xy''}{y''} = x;$$

$$Y'' = \frac{\frac{dY}{dx}}{\frac{dX}{dx}} = \frac{1}{y''};$$

$$Y''' = \frac{\frac{dY''}{dx}}{\frac{dX}{dx}} = \frac{-\frac{y'''}{y''^2}}{y''} = -\frac{y'''}{y''^3}.$$

引入新变量 ξ 及 η , 解下列方程:

$$3458. \quad \frac{\partial z}{\partial x} = \frac{\partial z}{\partial y}, \quad \text{令 } \xi = x + y, \eta = x - y.$$

解 当仅作为自变量代换, 引入新自变量

$$\xi = \xi(x, y), \quad \eta = \eta(x, y)$$

这个最简单的情形时, 只要把 ξ, η 看作中间变量, 用复合函数求偏导函数的公式, 即可求出:

$$\frac{\partial z}{\partial x} = \frac{\partial z}{\partial \xi} \frac{\partial \xi}{\partial x} + \frac{\partial z}{\partial \eta} \frac{\partial \eta}{\partial x},$$

$$\frac{\partial z}{\partial y} = \frac{\partial z}{\partial \xi} \frac{\partial \xi}{\partial y} + \frac{\partial z}{\partial \eta} \frac{\partial \eta}{\partial y}.$$

代入原方程, 即得变换后的方程. 本题中,

$$\frac{\partial \xi}{\partial x} = \frac{\partial \xi}{\partial y} = \frac{\partial \eta}{\partial x} = 1, \quad \frac{\partial \eta}{\partial y} = -1.$$

于是,

$$\frac{\partial z}{\partial x} = \frac{\partial z}{\partial \xi} + \frac{\partial z}{\partial \eta}, \quad \frac{\partial z}{\partial y} = \frac{\partial z}{\partial \xi} - \frac{\partial z}{\partial \eta}.$$

代入原方程, 得

$$\frac{\partial z}{\partial \xi} + \frac{\partial z}{\partial \eta} = \frac{\partial z}{\partial \xi} - \frac{\partial z}{\partial \eta} \quad \text{或} \quad \frac{\partial z}{\partial \eta} = 0,$$

即

$$z = \varphi(\xi) = \varphi(x + y),$$

其中 φ 为任意的函数.

3459. $y \frac{\partial z}{\partial x} - x \frac{\partial z}{\partial y} = 0$, 令 $\xi = x$, $\eta = x^2 + y^2$.

解 $\frac{\partial \xi}{\partial x} = 1$, $\frac{\partial \xi}{\partial y} = 0$, $\frac{\partial \eta}{\partial x} = 2x$, $\frac{\partial \eta}{\partial y} = 2y$.

于是,

$$\frac{\partial z}{\partial x} = \frac{\partial z}{\partial \xi} + 2x \frac{\partial z}{\partial \eta}, \quad \frac{\partial z}{\partial y} = 2y \frac{\partial z}{\partial \eta}.$$

代入原方程, 得

$$y \left(\frac{\partial z}{\partial \xi} + 2x \frac{\partial z}{\partial \eta} \right) - 2xy \frac{\partial z}{\partial \eta} = 0 \quad \text{或} \quad y \frac{\partial z}{\partial \xi} = 0.$$

由于 $y \neq 0$, 故 $\frac{\partial z}{\partial \xi} = 0$, 即

$$z = \varphi(\eta) = \varphi(x^2 + y^2),$$

其中 φ 为任意的函数.

3460. $a \frac{\partial z}{\partial x} + b \frac{\partial z}{\partial y} = 1$ ($a \neq 0$), 令 $\xi = x$, $\eta = y - bx$.

解 当变量间的变换关系比较复杂时, 用全微分法较好. 首先, 根据新旧变元之间的关系, 求出它们微分之间的关系

$$d\xi = dx, \quad d\eta = dy - b dz. \quad (1)$$

其次, 将所求得的微分式代入表示新变元关系的全微分式, 并按旧变元关系重新整理.

$$dz = \frac{\partial z}{\partial \xi} d\xi + \frac{\partial z}{\partial \eta} d\eta = \frac{\partial z}{\partial \xi} dx + \frac{\partial z}{\partial \eta} (dy - b dz),$$

$$\left(1 + b \frac{\partial z}{\partial \eta}\right) dz = \frac{\partial z}{\partial \xi} dx + \frac{\partial z}{\partial \eta} dy,$$

$$dz = \frac{\frac{\partial z}{\partial \xi}}{1 + b \frac{\partial z}{\partial \eta}} dx + \frac{\frac{\partial z}{\partial \eta}}{1 + b \frac{\partial z}{\partial \eta}} dy.$$

把整理后的式子与表示旧变元的全微分式

$$dz = \frac{\partial z}{\partial x} dx + \frac{\partial z}{\partial y} dy$$

比较, 即得

$$\frac{\partial z}{\partial x} = \frac{\frac{\partial z}{\partial \xi}}{1 + b \frac{\partial z}{\partial \eta}}, \quad \frac{\partial z}{\partial y} = \frac{\frac{\partial z}{\partial \eta}}{1 + b \frac{\partial z}{\partial \eta}}.$$

代入原方程, 得

$$a \frac{\partial z}{\partial \xi} + b \frac{\partial z}{\partial \eta} = 1 + b \frac{\partial z}{\partial \eta} \quad \text{或} \quad \frac{\partial z}{\partial \xi} = \frac{1}{a}.$$

于是,

$$z = \frac{\xi}{a} + \varphi(\eta) = \frac{x}{a} + \varphi(y - bz).$$

3461. $x \frac{\partial z}{\partial x} + y \frac{\partial z}{\partial y} = z$, 令 $\xi = x$ 及 $\eta = \frac{y}{x}$.

解 $\frac{\partial \xi}{\partial x} = 1$, $\frac{\partial \xi}{\partial y} = 0$, $\frac{\partial \eta}{\partial x} = -\frac{y}{x^2}$, $\frac{\partial \eta}{\partial y} = \frac{1}{x}$.

$$\frac{\partial z}{\partial x} = \frac{\partial z}{\partial \xi} - \frac{y}{x^2} \frac{\partial z}{\partial \eta}, \quad \frac{\partial z}{\partial y} = \frac{1}{x} \frac{\partial z}{\partial \eta}.$$

代入原方程, 得

$$x \left(\frac{\partial z}{\partial \xi} - \frac{y}{x^2} \frac{\partial z}{\partial \eta} \right) + \frac{y}{x} \frac{\partial z}{\partial \eta} = z,$$

$$x \frac{\partial z}{\partial \xi} = z \text{ 或 } \xi \frac{\partial z}{\partial \xi} = z.$$

解之, 得

$$z = \xi \varphi(\eta) = x \varphi\left(\frac{y}{x}\right).$$

取 u 与 v 作新的自变量, 变换下列方程式:

3462. $x \frac{\partial z}{\partial x} + \sqrt{1+y^2} \frac{\partial z}{\partial y} = xy$, 若 $u = \ln x$,

$$v = \ln(y + \sqrt{1+y^2}).$$

解 $\frac{\partial u}{\partial x} = \frac{1}{x}$, $\frac{\partial u}{\partial y} = 0$, $\frac{\partial v}{\partial x} = 0$, $\frac{\partial v}{\partial y} = \frac{1}{\sqrt{1+y^2}}$.

$$\frac{\partial z}{\partial x} = \frac{1}{x} \frac{\partial z}{\partial u}, \quad \frac{\partial z}{\partial y} = \frac{1}{\sqrt{1+y^2}} \frac{\partial z}{\partial v}.$$

注意到 $x=e^u$ 及 $y=\operatorname{sh}v$, 代入原方程, 即得

$$\frac{\partial z}{\partial u} + \frac{\partial z}{\partial v} = e^u \operatorname{sh}v.$$

3463. $(x+y)\frac{\partial z}{\partial x} - (x-y)\frac{\partial z}{\partial y} = 0$, 若 $u = \ln\sqrt{x^2+y^2}$,

$$v = \operatorname{arc} \operatorname{tg} \frac{y}{x}.$$

解 $\frac{\partial u}{\partial x} = \frac{x}{x^2+y^2}, \quad \frac{\partial u}{\partial y} = \frac{y}{x^2+y^2},$

$$\frac{\partial v}{\partial x} = -\frac{y}{x^2+y^2}, \quad \frac{\partial v}{\partial y} = \frac{x}{x^2+y^2}.$$

$$\frac{\partial z}{\partial x} = \frac{x}{x^2+y^2} \frac{\partial z}{\partial u} - \frac{y}{x^2+y^2} \frac{\partial z}{\partial v},$$

$$\frac{\partial z}{\partial y} = -\frac{y}{x^2+y^2} \frac{\partial z}{\partial u} + \frac{x}{x^2+y^2} \frac{\partial z}{\partial v}.$$

代入原方程, 得

$$\frac{x+y}{x^2+y^2} \left(x \frac{\partial z}{\partial u} - y \frac{\partial z}{\partial v} \right) - \frac{x-y}{x^2+y^2}$$

$$\cdot \left(y \frac{\partial z}{\partial u} + x \frac{\partial z}{\partial v} \right) = 0,$$

$$\frac{\partial z}{\partial u} - \frac{\partial z}{\partial v} = 0 \text{ 或 } \frac{\partial z}{\partial u} = \frac{\partial z}{\partial v}.$$

$$3464. \quad x \frac{\partial z}{\partial x} + y \frac{\partial z}{\partial y} = z + \sqrt{x^2 + y^2 + z^2}, \quad \text{若 } u = \frac{y}{x},$$

$$v = z + \sqrt{x^2 + y^2 + z^2}.$$

解 本题用微分法较好。

$$du = \frac{xdy - ydx}{x^2}.$$

$$dv = dz + \frac{xdx + ydy + zdz}{\sqrt{x^2 + y^2 + z^2}}$$

$$= dz + \frac{xdx + ydy + zdz}{r}$$

$$(r = \sqrt{x^2 + y^2 + z^2}).$$

$$dz = \frac{\partial z}{\partial u} du + \frac{\partial z}{\partial v} dv = \frac{\partial z}{\partial u} \left(\frac{dy}{x} - \frac{ydx}{x^2} \right)$$

$$+ \frac{\partial z}{\partial v} \left(dz + \frac{x}{r} dx + \frac{y}{r} dy + \frac{z}{r} dz \right).$$

于是,

$$\left(1 - \frac{\partial z}{\partial v} - \frac{z}{r} \frac{\partial z}{\partial v} \right) dz = \left(-\frac{y}{x^2} \frac{\partial z}{\partial u} + \frac{x}{r} \frac{\partial z}{\partial v} \right) dx$$

$$+ \left(\frac{1}{x} \frac{\partial z}{\partial u} + \frac{y}{r} \frac{\partial z}{\partial v} \right) dy,$$

$$\frac{\partial z}{\partial x} = \left(-\frac{y}{x^2} \frac{\partial z}{\partial u} + \frac{x}{r} \frac{\partial z}{\partial v} \right) \left(1 - \frac{\partial z}{\partial v} - \frac{z}{r} \frac{\partial z}{\partial v} \right)^{-1},$$

$$\frac{\partial z}{\partial y} = \left(\frac{1}{x} \frac{\partial z}{\partial u} + \frac{y}{r} \frac{\partial z}{\partial v} \right) \left(1 - \frac{\partial z}{\partial v} - \frac{z}{r} \frac{\partial z}{\partial v} \right)^{-1}.$$

代入原方程，得

$$\begin{aligned} & x \left(-\frac{y}{x^2} \frac{\partial z}{\partial u} + \frac{x}{r} \frac{\partial z}{\partial v} \right) + y \left(\frac{1}{x} \frac{\partial z}{\partial u} + \frac{y}{r} \frac{\partial z}{\partial v} \right) \\ &= (z+r) \left(1 - \frac{\partial z}{\partial v} - \frac{z}{r} \frac{\partial z}{\partial v} \right), \\ & 2(z+r) \frac{\partial z}{\partial v} = z+r. \end{aligned}$$

如果 $z+r=0$ ，则可推得 $x^2+y^2=0$ ；但由于 $x \neq 0$ ，所以 x^2+y^2 不可能为零。于是， $z+r \neq 0$ ，从而得

$$\frac{\partial z}{\partial v} = \frac{1}{2}.$$

3465. $x \frac{\partial z}{\partial x} + y \frac{\partial z}{\partial y} = \frac{x}{z}$ ，若 $u=2x-z^2$ ， $v=\frac{y}{z}$ 。

解 $du=2dx-2zdz$ ， $dv=\frac{dy}{z}-\frac{y}{z^2}dz$ 。

$$\begin{aligned} dz &= \frac{\partial z}{\partial u} du + \frac{\partial z}{\partial v} dv = \frac{\partial z}{\partial u} (2dx - z dz) \\ &+ \frac{\partial z}{\partial v} \left(\frac{1}{z} dy - \frac{y}{z^2} dz \right). \end{aligned}$$

于是，

$$\left(1 + 2z \frac{\partial z}{\partial u} + \frac{y}{z^2} \frac{\partial z}{\partial v} \right) dz = 2 \frac{\partial z}{\partial u} dx + \frac{1}{z} \frac{\partial z}{\partial v} dy,$$

$$\frac{\partial z}{\partial x} = 2 \frac{\partial z}{\partial u} \left(1 + 2z \frac{\partial z}{\partial u} + \frac{y}{z^2} \frac{\partial z}{\partial v} \right)^{-1},$$

$$\frac{\partial z}{\partial y} = \frac{1}{z} \frac{\partial z}{\partial v} \left(1 + 2z \frac{\partial z}{\partial u} + \frac{y}{z^2} \frac{\partial z}{\partial v} \right)^{-1}.$$

代入原方程，得

$$2x \frac{\partial z}{\partial u} + y \cdot \frac{1}{z} \frac{\partial z}{\partial v} = \frac{x}{z} \left(1 + 2z \frac{\partial z}{\partial u} + \frac{y}{z^2} \frac{\partial z}{\partial v} \right),$$

$$\left(\frac{y}{z} - \frac{xy}{z^3} \right) \frac{\partial z}{\partial v} = \frac{x}{z}.$$

再以 $y = zv$, $x = \frac{1}{2}(u + z^2)$ 代入上式，最后得

$$\frac{\partial z}{\partial v} = \frac{z}{v} \cdot \frac{z^2 + u}{z^2 - u}.$$

3466⁺. $(x+z) \frac{\partial z}{\partial x} + (y+z) \frac{\partial z}{\partial y} = x+y+z$, 若 $u = x+z$,

$$v = y+z.$$

$$\text{解 } dz = \frac{\partial z}{\partial u} du + \frac{\partial z}{\partial v} dv = \frac{\partial z}{\partial u} (dx + dz)$$

$$+ \frac{\partial z}{\partial v} (dy + dz).$$

于是，

$$\left(1 - \frac{\partial z}{\partial u} - \frac{\partial z}{\partial v} \right) dz = \frac{\partial z}{\partial u} dx + \frac{\partial z}{\partial v} dy,$$

$$\frac{\partial z}{\partial x} = \frac{\partial z}{\partial u} \left(1 - \frac{\partial z}{\partial u} - \frac{\partial z}{\partial v} \right)^{-1},$$

$$\frac{\partial z}{\partial y} = \frac{\partial z}{\partial v} \left(1 - \frac{\partial z}{\partial u} - \frac{\partial z}{\partial v} \right)^{-1}.$$

将 $\frac{\partial z}{\partial x}$ 及 $\frac{\partial z}{\partial y}$ 代入原方程, 并注意到 $x+y+z=u+v-z$, 即得

$$u \frac{\partial z}{\partial u} + v \frac{\partial z}{\partial v} = (u+v-z) \left(1 - \frac{\partial z}{\partial u} - \frac{\partial z}{\partial v} \right),$$

$$(2u+v-z) \frac{\partial z}{\partial u} + (2v+u-z) \frac{\partial z}{\partial v} = u+v-z.$$

3467. 取

$$\xi = y + ze^{-x}, \quad \eta = x + ze^{-y}$$

作为新的自变量, 变换式子

$$(z + e^x) \frac{\partial z}{\partial x} + (z + e^y) \frac{\partial z}{\partial y} = (z^2 - e^{x+y}).$$

$$\text{解 } dz = \frac{\partial z}{\partial \xi} d\xi + \frac{\partial z}{\partial \eta} d\eta$$

$$= \frac{\partial z}{\partial \xi} (dy + e^{-x} dz - ze^{-x} dx) + \frac{\partial z}{\partial \eta}$$

$$\cdot (dx + e^{-y} dz - ze^{-y} dy),$$

于是,

$$\left(1 - e^{-x} \frac{\partial z}{\partial \xi} - e^{-y} \frac{\partial z}{\partial \eta} \right) dz = \left(\frac{\partial z}{\partial \eta} - ze^{-x} \frac{\partial z}{\partial \xi} \right) dx$$

$$+ \left(\frac{\partial z}{\partial \xi} - ze^{-y} \frac{\partial z}{\partial \eta} \right) dy,$$

$$\frac{\partial z}{\partial x} = \left(\frac{\partial z}{\partial \eta} - ze^{-x} \frac{\partial z}{\partial \xi} \right) \left(1 - e^{-x} \frac{\partial z}{\partial \xi} - e^{-y} \frac{\partial z}{\partial \eta} \right)^{-1},$$

$$\frac{\partial z}{\partial y} = \left(\frac{\partial z}{\partial \xi} - ze^{-y} \frac{\partial z}{\partial \eta} \right) \left(1 - e^{-x} \frac{\partial z}{\partial \xi} - e^{-y} \frac{\partial z}{\partial \eta} \right)^{-1}.$$

代入原式，化简整理即得

$$\text{原式} = \frac{e^{x+y} - z^2}{1 - e^{-x} \frac{\partial z}{\partial \xi} - e^{-y} \frac{\partial z}{\partial \eta}}.$$

3468. 假定

$$x = uv, \quad y = \frac{1}{2}(u^2 - v^2)$$

变换式子

$$\left(\frac{\partial z}{\partial x} \right)^2 + \left(\frac{\partial z}{\partial y} \right)^2.$$

解 $dx = vdu + u dv$, $dy = udu - v dv$. 解之，得

$$du = \frac{v dx + u dy}{u^2 + v^2}, \quad dv = \frac{u dx - v dy}{u^2 + v^2}.$$

于是，

$$\begin{aligned} dz &= \frac{\partial z}{\partial u} du + \frac{\partial z}{\partial v} dv = \frac{1}{u^2 + v^2} \left[\frac{\partial z}{\partial u} (v dx + u dy) \right. \\ &\quad \left. + \frac{\partial z}{\partial v} (u dx - v dy) \right] \\ &= \frac{1}{u^2 + v^2} \left[\left(v \frac{\partial z}{\partial u} + u \frac{\partial z}{\partial v} \right) dx + \left(u \frac{\partial z}{\partial u} - v \frac{\partial z}{\partial v} \right) dy \right], \end{aligned}$$

$$\begin{aligned} \left(\frac{\partial z}{\partial x}\right)^2 + \left(\frac{\partial z}{\partial y}\right)^2 &= \frac{1}{(u^2 + v^2)^2} \left[\left(v \frac{\partial z}{\partial u} + u \frac{\partial z}{\partial v} \right)^2 \right. \\ &\quad \left. + \left(u \frac{\partial z}{\partial u} - v \frac{\partial z}{\partial v} \right)^2 \right] \\ &= \frac{1}{u^2 + v^2} \left[\left(\frac{\partial z}{\partial u} \right)^2 + \left(\frac{\partial z}{\partial v} \right)^2 \right]. \end{aligned}$$

3469. 于方程

$$\frac{\partial u}{\partial x} + \frac{\partial u}{\partial y} + \frac{\partial u}{\partial z} = 0$$

中令 $\xi = x$, $\eta = y - x$, $\zeta = z - x$.

$$\text{解 } \frac{\partial u}{\partial x} = \frac{\partial u}{\partial \xi} \frac{\partial \xi}{\partial x} + \frac{\partial u}{\partial \eta} \frac{\partial \eta}{\partial x} + \frac{\partial u}{\partial \zeta} \frac{\partial \zeta}{\partial x}$$

$$= \frac{\partial u}{\partial \xi} - \frac{\partial u}{\partial \eta} - \frac{\partial u}{\partial \zeta},$$

$$\frac{\partial u}{\partial y} = \frac{\partial u}{\partial \eta}, \quad \frac{\partial u}{\partial z} = \frac{\partial u}{\partial \zeta}.$$

三式相加即得

$$\frac{\partial u}{\partial \xi} = 0.$$

3470. 取 x 作为函数, 而 y 和 z 作为自变量, 变换方程

$$(x - z) \frac{\partial z}{\partial x} + y \frac{\partial z}{\partial y} = 0.$$

$$\text{解 } dx = \frac{\partial x}{\partial y} dy + \frac{\partial x}{\partial z} dz, \quad dz = \frac{1}{\frac{\partial x}{\partial x}} dx - \frac{\frac{\partial x}{\partial y}}{\frac{\partial x}{\partial z}} dy.$$

于是,

$$\frac{\partial z}{\partial x} = \frac{1}{\frac{\partial x}{\partial z}}, \quad \frac{\partial z}{\partial y} = -\frac{\frac{\partial x}{\partial y}}{\frac{\partial x}{\partial z}}.$$

代入原方程, 得

$$(x-z) \cdot \frac{1}{\frac{\partial x}{\partial z}} - y \cdot \frac{\frac{\partial x}{\partial y}}{\frac{\partial x}{\partial z}} = 0,$$

即

$$\frac{\partial x}{\partial y} = \frac{x-z}{y} \quad (y \neq 0).$$

3471. 取 x 作为函数, 而 $u=y-z$, $v=y+z$ 作为自变量, 变换方程

$$(y-z) \frac{\partial z}{\partial x} + (y+z) \frac{\partial z}{\partial y} = 0.$$

解 $du = dy - dz$, $dv = dy + dz$.

$$\begin{aligned} dx &= \frac{\partial x}{\partial u} du + \frac{\partial x}{\partial v} dv = \frac{\partial x}{\partial u} (dy - dz) \\ &\quad + \frac{\partial x}{\partial v} (dy + dz). \end{aligned}$$

于是,

$$\left(\frac{\partial x}{\partial u} - \frac{\partial x}{\partial v} \right) dz = -dx + \left(\frac{\partial x}{\partial u} + \frac{\partial x}{\partial v} \right) dy,$$

$$\frac{\partial z}{\partial x} = -\frac{1}{\frac{\partial x}{\partial u} - \frac{\partial x}{\partial v}}, \quad \frac{\partial z}{\partial y} = \frac{\frac{\partial x}{\partial u} + \frac{\partial x}{\partial v}}{\frac{\partial x}{\partial u} - \frac{\partial x}{\partial v}}.$$

代入原方程，去分母，即得

$$\frac{\partial x}{\partial u} + \frac{\partial x}{\partial v} = \frac{u}{v} \quad (v \neq 0).$$

3472⁺. 取 x 作为函数及 $u = xz$, $v = yz$ 作为自变量，变换式子

$$A = \left(\frac{\partial z}{\partial x}\right)^2 + \left(\frac{\partial z}{\partial y}\right)^2.$$

解 $du = xdz + zdx$, $dv = ydz + zdy$.

$$\begin{aligned} dx &= \frac{\partial x}{\partial u} du + \frac{\partial x}{\partial v} dv = \frac{\partial x}{\partial u} (xdz + zdx) \\ &\quad + \frac{\partial x}{\partial v} (ydz + zdy). \end{aligned}$$

于是，

$$\left(x \frac{\partial x}{\partial u} + y \frac{\partial x}{\partial v}\right) dz = \left(1 - z \frac{\partial x}{\partial u}\right) dx - z \frac{\partial x}{\partial v} dy,$$

$$\frac{\partial z}{\partial x} = \frac{1 - z \frac{\partial x}{\partial u}}{x \frac{\partial x}{\partial u} + y \frac{\partial x}{\partial v}}, \quad \frac{\partial z}{\partial y} = -\frac{z \frac{\partial x}{\partial v}}{x \frac{\partial x}{\partial u} + y \frac{\partial x}{\partial v}}.$$

代入原式，即得

$$\begin{aligned}
A &= \frac{\left(1 - z \frac{\partial x}{\partial u}\right)^2 + z^2 \left(\frac{\partial x}{\partial v}\right)^2}{\left(x \frac{\partial x}{\partial u} + y \frac{\partial x}{\partial v}\right)^2} \\
&= \frac{1 - 2z \frac{\partial x}{\partial u} + z^2 \left[\left(\frac{\partial x}{\partial u}\right)^2 + \left(\frac{\partial x}{\partial v}\right)^2 \right]}{\left(x \frac{\partial x}{\partial u} + y \frac{\partial x}{\partial v}\right)^2} \\
&= \frac{1 - 2 \cdot \frac{u}{x} \frac{\partial x}{\partial u} + \left(\frac{u}{x}\right)^2 \left[\left(\frac{\partial x}{\partial u}\right)^2 + \left(\frac{\partial x}{\partial v}\right)^2 \right]}{x^2 \left(\frac{\partial x}{\partial u} + \frac{v}{u} \frac{\partial x}{\partial v}\right)^2} \\
&= \frac{u^2 \left\{ x^2 - 2xu \frac{\partial x}{\partial u} + u^2 \left[\left(\frac{\partial x}{\partial u}\right)^2 + \left(\frac{\partial x}{\partial v}\right)^2 \right] \right\}}{x^4 \left(u \frac{\partial x}{\partial u} + v \frac{\partial x}{\partial v}\right)^2}
\end{aligned}$$

3473. 于方程

$$\begin{aligned}
&(y+z+u) \frac{\partial u}{\partial x} + (x+z+u) \frac{\partial u}{\partial y} \\
&+ (x+y+u) \frac{\partial u}{\partial z} = x+y+z
\end{aligned}$$

中, 令: $e^\xi = x-u$, $e^\eta = y-u$, $e^\zeta = z-u$.

$$\begin{aligned}
\text{解 } du &= \frac{\partial u}{\partial \xi} d\xi + \frac{\partial u}{\partial \eta} d\eta + \frac{\partial u}{\partial \zeta} d\zeta \\
&= \frac{\partial u}{\partial \xi} e^{-\xi} (dx - du) + \frac{\partial u}{\partial \eta} e^{-\eta} (dy - du) \\
&+ \frac{\partial u}{\partial \zeta} e^{-\zeta} (dz - du).
\end{aligned}$$

于是,

$$\begin{aligned} & \left(1 + e^{-\xi} \frac{\partial u}{\partial \xi} + e^{-\eta} \frac{\partial u}{\partial \eta} + e^{-\zeta} \frac{\partial u}{\partial \zeta}\right) du \\ &= e^{-\xi} \frac{\partial u}{\partial \xi} dx + e^{-\eta} \frac{\partial u}{\partial \eta} dy + e^{-\zeta} \frac{\partial u}{\partial \zeta} dz. \end{aligned}$$

將由上式所确定的 $\frac{\partial u}{\partial x}$, $\frac{\partial u}{\partial y}$ 及 $\frac{\partial u}{\partial z}$ 代入原方程, 即得

$$\begin{aligned} & (y+z+u)e^{-\xi} \frac{\partial u}{\partial \xi} + (x+z+u)e^{-\eta} \frac{\partial u}{\partial \eta} \\ & + (x+y+u)e^{-\zeta} \frac{\partial u}{\partial \zeta} \end{aligned}$$

$$= (x+y+z) \left(1 + e^{-\xi} \frac{\partial u}{\partial \xi} + e^{-\eta} \frac{\partial u}{\partial \eta} + e^{-\zeta} \frac{\partial u}{\partial \zeta}\right).$$

消去同类项, 得

$$\begin{aligned} & (x-u)e^{-\xi} \frac{\partial u}{\partial \xi} + (y-u)e^{-\eta} \frac{\partial u}{\partial \eta} + (z-u)e^{-\zeta} \frac{\partial u}{\partial \zeta} \\ & + (x+y+z) = 0, \end{aligned}$$

即

$$\frac{\partial u}{\partial \xi} + \frac{\partial u}{\partial \eta} + \frac{\partial u}{\partial \zeta} + 3u + e^{\xi} + e^{\eta} + e^{\zeta} = 0.$$

于下列方程中, 代入新的变量 u, v, w , 其中 $w = w(u, v)$:

3474. $y \frac{\partial z}{\partial x} - x \frac{\partial z}{\partial y} = (y-x)z$, 令 $u = x^2 + y^2$, $v = \frac{1}{x} + \frac{1}{y}$,

$$w = \ln z - (x+y).$$

解 $du = 2x dx + 2y dy$, $dv = -\frac{1}{x^2} dx - \frac{1}{y^2} dy$,

$$dw = \frac{1}{z} dz - dx - dy.$$

另一方面, $dw = \frac{\partial w}{\partial u} du + \frac{\partial w}{\partial v} dv$, 故有

$$\frac{1}{z} dz - dx - dy = \frac{\partial w}{\partial u} (2x dx + 2y dy)$$

$$+ \frac{\partial w}{\partial v} \left(-\frac{1}{x^2} dx - \frac{1}{y^2} dy \right).$$

整理得

$$dz = \left(2xz \frac{\partial w}{\partial u} - \frac{z}{x^2} \frac{\partial w}{\partial v} + z \right) dx$$

$$+ \left(2yz \frac{\partial w}{\partial u} - \frac{z}{y^2} \frac{\partial w}{\partial v} + z \right) dy.$$

將由上式所確定的 $\frac{\partial z}{\partial x}$ 及 $\frac{\partial z}{\partial y}$ 代入原方程, 得

$$yz \left(2x \frac{\partial w}{\partial u} - \frac{1}{x^2} \frac{\partial w}{\partial v} + 1 \right)$$

$$- xz \left(2y \frac{\partial w}{\partial u} - \frac{1}{y^2} \frac{\partial w}{\partial v} + 1 \right)$$

$$= (y-x)z,$$

即

$$\frac{\partial w}{\partial v} = 0.$$

3475. $x^2 \frac{\partial z}{\partial x} + y^2 \frac{\partial z}{\partial y} = z^2$, 令 $u=x$, $v = \frac{1}{y} - \frac{1}{x}$,

$$w = \frac{1}{z} - \frac{1}{x}.$$

解 $du = dx$, $dv = \frac{1}{x^2} dx - \frac{1}{y^2} dy$, $dw = \frac{1}{x^2} dx - \frac{1}{z^2} dz$. 于是,

$$\frac{1}{x^2} dx - \frac{1}{z^2} dz = \frac{\partial w}{\partial u} dx + \frac{\partial w}{\partial v} \left(\frac{1}{x^2} dx - \frac{1}{y^2} dy \right),$$

$$dz = z^2 \left(\frac{1}{x^2} - \frac{\partial w}{\partial u} - \frac{1}{x^2} \frac{\partial w}{\partial v} \right) dx + \frac{z^2}{y^2} \frac{\partial w}{\partial v} dy,$$

$$\frac{\partial z}{\partial x} = z^2 \left(\frac{1}{x^2} - \frac{\partial w}{\partial u} - \frac{1}{x^2} \frac{\partial w}{\partial v} \right), \quad \frac{\partial z}{\partial y} = \frac{z^2}{y^2} \frac{\partial w}{\partial v}.$$

代入原方程, 得

$$z^2 \left(1 - x^2 \frac{\partial w}{\partial u} - \frac{\partial w}{\partial v} \right) + z^2 \frac{\partial w}{\partial v} = z^2$$

或 $x^2 z^2 \frac{\partial w}{\partial u} = 0$.

由于 $z \neq 0$, $x \neq 0$, 故得

$$\frac{\partial w}{\partial u} = 0.$$

3476. $(xy+z) \frac{\partial z}{\partial x} + (1-y^2) \frac{\partial z}{\partial y} = x+yz$, 设 $u = yz - x$,

$$v = xz - y, \quad w = xy - z.$$

解 $dw = ydx + xdy - dz = \frac{\partial w}{\partial u} (zdy + ydz - dx)$

$$+ \frac{\partial w}{\partial v}(zdx + xdz - dy).$$

整理得

$$\begin{aligned} \left(1 + x \frac{\partial w}{\partial v} + y \frac{\partial w}{\partial u}\right) dz &= \left(y + \frac{\partial w}{\partial u} - z \frac{\partial w}{\partial v}\right) dx \\ &+ \left(x + \frac{\partial w}{\partial v} - z \frac{\partial w}{\partial u}\right) dy. \end{aligned}$$

于是,

$$\frac{\partial z}{\partial x} = \left(y + \frac{\partial w}{\partial u} - z \frac{\partial w}{\partial v}\right) \left(1 + x \frac{\partial w}{\partial v} + y \frac{\partial w}{\partial u}\right)^{-1},$$

$$\frac{\partial z}{\partial y} = \left(x + \frac{\partial w}{\partial v} - z \frac{\partial w}{\partial u}\right) \left(1 + x \frac{\partial w}{\partial v} + y \frac{\partial w}{\partial u}\right)^{-1}.$$

代入原方程, 得

$$\begin{aligned} &(xy + z) \left(y + \frac{\partial w}{\partial u} - z \frac{\partial w}{\partial v}\right) \\ &+ (1 - y^2) \left(x + \frac{\partial w}{\partial v} - z \frac{\partial w}{\partial u}\right) \\ &= (x + yz) \left(1 + x \frac{\partial w}{\partial v} + y \frac{\partial w}{\partial u}\right), \end{aligned}$$

即

$$(1 - x^2 - y^2 - z^2 - 2xyz) \frac{\partial w}{\partial v} = 0.$$

不难验证, 由方程 $1 - x^2 - y^2 - z^2 - 2xyz = 0$ 所确定的隐函数不是原方程的解 (证略). 于是,

$$\frac{\partial w}{\partial v} = 0.$$

3477. $\left(x \frac{\partial z}{\partial x}\right)^2 + \left(y \frac{\partial z}{\partial y}\right)^2 = z^2 \frac{\partial z}{\partial x} \frac{\partial z}{\partial y}$, 令 $x = ue^w, y = ve^w$,

$$z = we^w.$$

解 $dx = e^w du + ue^w dw, dy = e^w dv + ve^w dw,$

$$dz = e^w(1+w)dw.$$

于是, 有

$$e^w dw = \frac{1}{1+w} dz,$$

$$e^w du = dx - ue^w dw = dx - \frac{u}{1+w} dz,$$

$$e^w dv = dy - ve^w dw = dy - \frac{v}{1+w} dz.$$

在全微分式 $dw = \frac{\partial w}{\partial u} du + \frac{\partial w}{\partial v} dv$ 的两端都乘以 e^w , 并

将上述结果代入, 得

$$\begin{aligned} \frac{dz}{1+w} &= \frac{\partial w}{\partial u} \left(dx - \frac{u}{1+w} dz \right) \\ &\quad + \frac{\partial w}{\partial v} \left(dy - \frac{v}{1+w} dz \right) \end{aligned}$$

或

$$\left(1 + u \frac{\partial w}{\partial u} + v \frac{\partial w}{\partial v} \right) dz = (1+w) \frac{\partial w}{\partial u} dx$$

$$+(1+w) \frac{\partial w}{\partial v} dy.$$

將由上式所确定的 $\frac{\partial z}{\partial x}$ 及 $\frac{\partial z}{\partial y}$ 代入原方程, 得

$$\begin{aligned} & \left[ue^w(1+w) \frac{\partial w}{\partial u} \right]^2 + \left[ve^w(1+w) \frac{\partial w}{\partial v} \right]^2 \\ &= (we^w)^2(1+w)^2 \frac{\partial w}{\partial u} \frac{\partial w}{\partial v}. \end{aligned}$$

消去 $[e^w(1+w)]^2$, 即得

$$u^2 \left(\frac{\partial w}{\partial u} \right)^2 + v^2 \left(\frac{\partial w}{\partial v} \right)^2 = w^2 \frac{\partial w}{\partial u} \frac{\partial w}{\partial v}.$$

3478. 假定 $u = \ln \sqrt{x^2 + y^2}$, $v = \operatorname{arc} \operatorname{tg} z$, $w = x + y + z$, 其中 $w = w(u, v)$, 变换式子

$$(x-y) : \left(\frac{\partial z}{\partial x} - \frac{\partial z}{\partial y} \right).$$

$$\begin{aligned} \text{解 } dw &= dx + dy + dz = \frac{\partial w}{\partial u} du + \frac{\partial w}{\partial v} dv \\ &= \frac{\partial w}{\partial u} \left(\frac{x dx + y dy}{x^2 + y^2} \right) + \frac{\partial w}{\partial v} \left(\frac{dz}{1+z^2} \right). \end{aligned}$$

于是,

$$\begin{aligned} \left(1 - \frac{1}{1+z^2} \frac{\partial w}{\partial v} \right) dz &= \left(\frac{x}{x^2+y^2} \frac{\partial w}{\partial u} - 1 \right) dx \\ &+ \left(\frac{y}{x^2+y^2} \frac{\partial w}{\partial u} - 1 \right) dy. \end{aligned}$$

将由上式所确定的 $\frac{\partial z}{\partial x}$ 及 $\frac{\partial z}{\partial y}$ 代入所给式子, 即得

$$\begin{aligned} \frac{x-y}{\frac{\partial z}{\partial x} - \frac{\partial z}{\partial y}} &= \frac{(x-y) \left(1 - \frac{1}{1+z^2} \frac{\partial w}{\partial v} \right)}{\frac{x-y}{x^2+y^2} \frac{\partial w}{\partial u}} \\ &= \frac{(1 - \cos^2 v) \frac{\partial w}{\partial v} e^{2v}}{\frac{\partial w}{\partial u}}. \end{aligned}$$

3479. 假定 $u = xe^z$, $v = ye^z$, $w = ze^z$, 其中 $w = w(u, v)$.
变换式子

$$A = \frac{\partial z}{\partial x} \cdot \frac{\partial z}{\partial y}.$$

$$\begin{aligned} \text{解 } dw &= e^z(1+z)dz = \frac{\partial w}{\partial u} du + \frac{\partial w}{\partial v} dv \\ &= \frac{\partial w}{\partial u} (e^z dx + xe^z dz) + \frac{\partial w}{\partial v} (e^z dy + ye^z dz). \end{aligned}$$

于是,

$$\left(1+z - x \frac{\partial w}{\partial u} - y \frac{\partial w}{\partial v} \right) dz = \frac{\partial w}{\partial u} dx + \frac{\partial w}{\partial v} dy,$$

$$\frac{\partial z}{\partial x} = \frac{\frac{\partial w}{\partial u}}{1+z - x \frac{\partial w}{\partial u} - y \frac{\partial w}{\partial v}},$$

$$\frac{\partial z}{\partial y} = \frac{\frac{\partial w}{\partial v}}{1 + z - x \frac{\partial w}{\partial u} - y \frac{\partial w}{\partial v}},$$

$$A = \frac{\partial z}{\partial x} \cdot \frac{\partial z}{\partial y} = \frac{\partial w}{\partial u} \cdot \frac{\partial w}{\partial v}.$$

3480. 在方程

$$x \frac{\partial u}{\partial x} + y \frac{\partial u}{\partial y} + z \frac{\partial u}{\partial z} = u + \frac{xy}{z}$$

中令: $\xi = \frac{x}{z}, \eta = \frac{y}{z}, \zeta = z, w = \frac{u}{z},$

其中 $w = w(\xi, \eta, \zeta).$

$$\begin{aligned} \text{解 } dw &= \frac{zdu - u dz}{z^2} = \frac{\partial w}{\partial \xi} d\xi + \frac{\partial w}{\partial \eta} d\eta + \frac{\partial w}{\partial \zeta} d\zeta \\ &= \frac{\partial w}{\partial \xi} \left(\frac{zdx - xdz}{z^2} \right) + \frac{\partial w}{\partial \eta} \left(\frac{zdy - ydz}{z^2} \right) \\ &\quad + \frac{\partial w}{\partial \zeta} dz. \end{aligned}$$

两端同乘 z^2 , 整理得

$$\begin{aligned} zdu &= z \frac{\partial w}{\partial \xi} dx + z \frac{\partial w}{\partial \eta} dy + \left(u - x \frac{\partial w}{\partial \xi} - y \frac{\partial w}{\partial \eta} \right. \\ &\quad \left. + z^2 \frac{\partial w}{\partial \zeta} \right) dz. \end{aligned}$$

将由上式所确定的 $\frac{\partial u}{\partial x}, \frac{\partial u}{\partial y}$ 及 $\frac{\partial u}{\partial z}$ 代入原方程, 得

$$x \frac{\partial w}{\partial \xi} + y \frac{\partial w}{\partial \eta} + \left(u - x \frac{\partial w}{\partial \xi} - y \frac{\partial w}{\partial \eta} + z^2 \frac{\partial w}{\partial \zeta} \right)$$

$$= u + \frac{xy}{z},$$

即

$$\frac{\partial w}{\partial \zeta} = \frac{xy}{z^3} = \frac{\xi \eta}{\zeta}.$$

假定 $x = r \cos \varphi$, $y = r \sin \varphi$, 改变下列各式为极坐标 r 和 φ 所表示的式子.

3481. $w = x \frac{\partial u}{\partial y} - y \frac{\partial u}{\partial x}.$

解 $dx = \cos \varphi dr - r \sin \varphi d\varphi,$

$dy = \sin \varphi dr + r \cos \varphi d\varphi.$

联立解之, 得

$$dr = \frac{x}{r} dx + \frac{y}{r} dy, \quad d\varphi = \frac{x}{r^2} dy - \frac{y}{r^2} dx.$$

于是,

$$du = \frac{\partial u}{\partial r} dr + \frac{\partial u}{\partial \varphi} d\varphi$$

$$= \left(\frac{x}{r} \frac{\partial u}{\partial r} - \frac{y}{r^2} \frac{\partial u}{\partial \varphi} \right) dx + \left(\frac{y}{r} \frac{\partial u}{\partial r} + \frac{x}{r^2} \frac{\partial u}{\partial \varphi} \right) dy,$$

$$\begin{cases} \frac{\partial u}{\partial x} = \frac{x}{r} \frac{\partial u}{\partial r} - \frac{y}{r^2} \frac{\partial u}{\partial \varphi}, \\ \frac{\partial u}{\partial y} = \frac{y}{r} \frac{\partial u}{\partial r} + \frac{x}{r^2} \frac{\partial u}{\partial \varphi}. \end{cases}$$

公式 9

將公式 9 代入原式，即得

$$\begin{aligned}w &= x \left(\frac{y}{r} \frac{\partial u}{\partial r} + \frac{x}{r^2} \frac{\partial u}{\partial \varphi} \right) - y \left(\frac{x}{r} \frac{\partial u}{\partial r} - \frac{y}{r^2} \frac{\partial u}{\partial \varphi} \right) \\ &= \frac{\partial u}{\partial \varphi}.\end{aligned}$$

3482. $w = x \frac{\partial u}{\partial x} + y \frac{\partial u}{\partial y}.$

解 將公式 9 代入，即得

$$\begin{aligned}w &= x \left(\frac{x}{r} \frac{\partial u}{\partial r} - \frac{y}{r^2} \frac{\partial u}{\partial \varphi} \right) + y \left(\frac{y}{r} \frac{\partial u}{\partial r} + \frac{x}{r^2} \frac{\partial u}{\partial \varphi} \right) \\ &= r \frac{\partial u}{\partial r}.\end{aligned}$$

3483. $w = \left(\frac{\partial u}{\partial x} \right)^2 + \left(\frac{\partial u}{\partial y} \right)^2.$

解 $w = \left(\frac{x}{r} \frac{\partial u}{\partial r} - \frac{y}{r^2} \frac{\partial u}{\partial \varphi} \right)^2 + \left(\frac{y}{r} \frac{\partial u}{\partial r} + \frac{x}{r^2} \frac{\partial u}{\partial \varphi} \right)^2$
 $= \left(\frac{\partial u}{\partial r} \right)^2 + \frac{1}{r^2} \left(\frac{\partial u}{\partial \varphi} \right)^2.$

3484. $w = \frac{\partial^2 u}{\partial x^2} + \frac{\partial^2 u}{\partial y^2}.$

解 先导出极坐标变换的所有二阶偏导函数的变换式。將 r, φ 看作中间变量， x, y 看作自变量。由于

$$d^2r = d(dr) = d\left(\frac{x}{r}dx + \frac{y}{r}dy\right)$$

$$= \frac{1}{r}(dx^2 + dy^2) - \frac{xdx + ydy}{r^2} dr$$

$$= \frac{1}{r}(dx^2 + dy^2) - \frac{1}{r^3}(xdx + ydy)^2$$

$$= \frac{1}{r^3}(ydx - xdy)^2,$$

$$d^2\varphi = d(d\varphi) = d\left(\frac{x}{r^2}dy - \frac{y}{r^2}dx\right)$$

$$= -\frac{2(xdy - ydx)}{r^3} dr$$

$$= -\frac{2}{r^4}(xdy - ydx)(xdx + ydy),$$

故有

$$d^2u = \frac{\partial^2 u}{\partial r^2} dr^2 + 2 \frac{\partial^2 u}{\partial r \partial \varphi} dr d\varphi + \frac{\partial^2 u}{\partial \varphi^2} d\varphi^2$$

$$+ \frac{\partial u}{\partial r} d^2r + \frac{\partial u}{\partial \varphi} d^2\varphi$$

$$= \frac{\partial^2 u}{\partial r^2} \cdot \left(\frac{xdx + ydy}{r}\right)^2 + 2 \frac{\partial^2 u}{\partial r \partial \varphi}$$

$$\cdot \left(\frac{xdx + ydy}{r}\right) \left(\frac{xdy - ydx}{r^2}\right)$$

$$+ \frac{\partial^2 u}{\partial \varphi^2} \left(\frac{xdy - ydx}{r^2}\right)^2 + \frac{\partial u}{\partial r} \frac{(ydx - xdy)^2}{r^3}$$

$$+ \frac{\partial u}{\partial \varphi} \left(-\frac{2}{r^4}\right)(xdy - ydx)(xdx + ydy).$$

将上式右端按 dx^2 , $dx dy$, dy^2 合并同类项, 并与全微分式

$$d^2u = \frac{\partial^2 u}{\partial x^2} dx^2 + 2 \frac{\partial^2 u}{\partial x \partial y} dx dy + \frac{\partial^2 u}{\partial y^2} dy^2$$

比较, 即得

$$\left\{ \begin{array}{l} \frac{\partial^2 u}{\partial x^2} = \frac{x^2}{r^2} \frac{\partial^2 u}{\partial r^2} - \frac{2xy}{r^3} \frac{\partial^2 u}{\partial r \partial \varphi} + \frac{y^2}{r^4} \frac{\partial^2 u}{\partial \varphi^2} \\ \quad + \frac{y^2}{r^3} \frac{\partial u}{\partial r} + \frac{2xy}{r^4} \frac{\partial u}{\partial \varphi}, \\ \frac{\partial^2 u}{\partial y^2} = \frac{y^2}{r^2} \frac{\partial^2 u}{\partial r^2} + \frac{2xy}{r^3} \frac{\partial^2 u}{\partial r \partial \varphi} + \frac{x^2}{r^4} \frac{\partial^2 u}{\partial \varphi^2} \\ \quad + \frac{x^2}{r^3} \frac{\partial u}{\partial r} - \frac{2xy}{r^4} \frac{\partial u}{\partial \varphi}, \\ \frac{\partial^2 u}{\partial x \partial y} = \frac{xy}{r^2} \frac{\partial^2 u}{\partial r^2} + \frac{x^2 - y^2}{r^3} \frac{\partial^2 u}{\partial r \partial \varphi} - \frac{xy}{r^4} \frac{\partial^2 u}{\partial \varphi^2} \\ \quad - \frac{xy}{r^3} \frac{\partial u}{\partial r} - \frac{x^2 - y^2}{r^2} \frac{\partial u}{\partial \varphi}. \end{array} \right. \quad \text{公式10}$$

将公式10代入原式, 即得

$$w = \frac{\partial^2 u}{\partial r^2} + \frac{1}{r^2} \frac{\partial^2 u}{\partial \varphi^2} + \frac{1}{r} \frac{\partial u}{\partial r}.$$

3485. $w = x^2 \frac{\partial^2 u}{\partial x^2} + 2xy \frac{\partial^2 u}{\partial x \partial y} + y^2 \frac{\partial^2 u}{\partial y^2}.$

解 将公式10代入原式, 化简整理得

$$w = r^2 \frac{\partial^2 u}{\partial r^2}.$$

$$3486. \quad w = y^2 \frac{\partial^2 z}{\partial x^2} - 2xy \frac{\partial^2 z}{\partial x \partial y} + x^2 \frac{\partial^2 z}{\partial y^2} \\ - \left(x \frac{\partial z}{\partial x} + y \frac{\partial z}{\partial y} \right).$$

解 将公式10中的 u 换成 z ，然后代入原式，化简整理得

$$w = \frac{\partial^2 z}{\partial \varphi^2}.$$

3487. 在式子

$$I = \frac{\partial u}{\partial x} \frac{\partial v}{\partial y} - \frac{\partial u}{\partial y} \frac{\partial v}{\partial x}$$

中，令 $x = r \cos \varphi$ ， $y = r \sin \varphi$ 。

解 对函数 u 及 v 分别用公式9，即得

$$I = \left(\frac{x}{r} \frac{\partial u}{\partial r} - \frac{y}{r^2} \frac{\partial u}{\partial \varphi} \right) \left(\frac{y}{r} \frac{\partial v}{\partial r} + \frac{x}{r^2} \frac{\partial v}{\partial \varphi} \right) \\ - \left(\frac{y}{r} \frac{\partial u}{\partial r} + \frac{x}{r^2} \frac{\partial u}{\partial \varphi} \right) \left(\frac{x}{r} \frac{\partial v}{\partial r} - \frac{y}{r^2} \frac{\partial v}{\partial \varphi} \right) \\ = \frac{1}{r} \left(\frac{\partial u}{\partial r} \frac{\partial v}{\partial \varphi} - \frac{\partial u}{\partial \varphi} \frac{\partial v}{\partial r} \right).$$

3488. 引用新的自变量

$$\xi = x - at, \quad \eta = x + at$$

解方程

$$\frac{\partial^2 u}{\partial t^2} = a^2 \frac{\partial^2 u}{\partial x^2}.$$

$$\text{解 } \frac{\partial u}{\partial t} = \frac{\partial u}{\partial \xi} \frac{\partial \xi}{\partial t} + \frac{\partial u}{\partial \eta} \frac{\partial \eta}{\partial t} = -a \frac{\partial u}{\partial \xi} + a \frac{\partial u}{\partial \eta},$$

$$\frac{\partial u}{\partial x} = \frac{\partial u}{\partial \xi} \frac{\partial \xi}{\partial x} + \frac{\partial u}{\partial \eta} \frac{\partial \eta}{\partial x} = \frac{\partial u}{\partial \xi} + \frac{\partial u}{\partial \eta}.$$

$$\frac{\partial^2 u}{\partial t^2} = \frac{\partial}{\partial t} \left(-a \frac{\partial u}{\partial \xi} + a \frac{\partial u}{\partial \eta} \right)$$

$$= a^2 \frac{\partial^2 u}{\partial \xi^2} - 2a^2 \frac{\partial^2 u}{\partial \xi \partial \eta} + a^2 \frac{\partial^2 u}{\partial \eta^2},$$

$$\frac{\partial^2 u}{\partial x^2} = \frac{\partial}{\partial x} \left(\frac{\partial u}{\partial \xi} + \frac{\partial u}{\partial \eta} \right) = \frac{\partial^2 u}{\partial \xi^2} + 2 \frac{\partial^2 u}{\partial \xi \partial \eta} + \frac{\partial^2 u}{\partial \eta^2}.$$

于是, 由 $\frac{\partial^2 u}{\partial t^2} = a^2 \frac{\partial^2 u}{\partial x^2}$ 得

$$\frac{\partial^2 u}{\partial \xi \partial \eta} = 0.$$

解之, 得 $\frac{\partial u}{\partial \xi} = f(\xi)$, 从而

$$u = \varphi(\xi) + \psi(\eta) = \varphi(x - at) + \psi(x + at),$$

其中 φ 及 ψ 为任意的函数.

取 u 及 v 作新的自变量, 变换下列方程:

$$3489. \quad 2 \frac{\partial^2 z}{\partial x^2} + \frac{\partial^2 z}{\partial x \partial y} - \frac{\partial^2 z}{\partial y^2} + \frac{\partial z}{\partial x} + \frac{\partial z}{\partial y} = 0,$$

设 $u = x + 2y + 2$ 及 $v = x - y - 1$.

$$\text{解 } \frac{\partial z}{\partial x} = \frac{\partial z}{\partial u} \frac{\partial u}{\partial x} + \frac{\partial z}{\partial v} \frac{\partial v}{\partial x} = \frac{\partial z}{\partial u} + \frac{\partial z}{\partial v},$$

$$\frac{\partial z}{\partial y} = 2 \frac{\partial z}{\partial u} - \frac{\partial z}{\partial v}.$$

$$\frac{\partial^2 z}{\partial x^2} = \frac{\partial^2 z}{\partial u^2} + 2 \frac{\partial^2 z}{\partial u \partial v} + \frac{\partial^2 z}{\partial v^2},$$

$$\frac{\partial^2 z}{\partial x \partial y} = \frac{\partial}{\partial y} \left(\frac{\partial z}{\partial x} \right) = 2 \frac{\partial^2 z}{\partial u^2} + \frac{\partial^2 z}{\partial u \partial v} - \frac{\partial^2 z}{\partial v^2},$$

$$\frac{\partial^2 z}{\partial y^2} = 4 \frac{\partial^2 z}{\partial u^2} - 4 \frac{\partial^2 z}{\partial u \partial v} + \frac{\partial^2 z}{\partial v^2}.$$

代入原方程，化简整理即得

$$3 \frac{\partial^2 z}{\partial u \partial v} + \frac{\partial z}{\partial u} = 0.$$

$$3490. (1+x^2) \frac{\partial^2 z}{\partial x^2} + (1+y^2) \frac{\partial^2 z}{\partial y^2} + x \frac{\partial z}{\partial x} + y \frac{\partial z}{\partial y} = 0,$$

设 $u = \ln(x + \sqrt{1+x^2})$ 及 $v = \ln(y + \sqrt{1+y^2})$.

$$\text{解 } \frac{\partial z}{\partial x} = \frac{\partial z}{\partial u} \frac{du}{dx} = \frac{1}{\sqrt{1+x^2}} \frac{\partial z}{\partial u},$$

$$\frac{\partial z}{\partial y} = \frac{1}{\sqrt{1+y^2}} \frac{\partial z}{\partial v},$$

$$\frac{\partial^2 z}{\partial x^2} = \frac{\partial}{\partial x} \left(\frac{1}{\sqrt{1+x^2}} \frac{\partial z}{\partial u} \right)$$

$$= -\frac{x}{(1+x^2)^{\frac{3}{2}}} \frac{\partial z}{\partial u} + \frac{1}{1+x^2} \frac{\partial^2 z}{\partial u^2},$$

$$\frac{\partial^2 z}{\partial y^2} = -\frac{y}{(1+y^2)^{\frac{3}{2}}} \frac{\partial z}{\partial v} + \frac{1}{1+y^2} \frac{\partial^2 z}{\partial v^2}.$$

代入原方程，化简整理得

$$\frac{\partial^2 z}{\partial u^2} + \frac{\partial^2 z}{\partial v^2} = 0.$$

3491⁺. $ax^2 \frac{\partial^2 z}{\partial x^2} + 2bxy \frac{\partial^2 z}{\partial x \partial y} + cy^2 \frac{\partial^2 z}{\partial y^2} = 0$ (a, b, c 为常数), 设 $u = \ln x, v = \ln y$.

解 $\frac{\partial z}{\partial x} = \frac{1}{x} \frac{\partial z}{\partial u}, \frac{\partial z}{\partial y} = \frac{1}{y} \frac{\partial z}{\partial v},$

$$\frac{\partial^2 z}{\partial x \partial y} = \frac{1}{xy} \frac{\partial^2 z}{\partial u \partial v},$$

$$\frac{\partial^2 z}{\partial x^2} = -\frac{1}{x^2} \frac{\partial z}{\partial u} + \frac{1}{x^2} \frac{\partial^2 z}{\partial u^2},$$

$$\frac{\partial^2 z}{\partial y^2} = -\frac{1}{y^2} \frac{\partial z}{\partial v} + \frac{1}{y^2} \frac{\partial^2 z}{\partial v^2}.$$

代入原方程，化简整理得

$$a\left(\frac{\partial^2 z}{\partial u^2} - \frac{\partial z}{\partial u}\right) + 2b \frac{\partial^2 z}{\partial u \partial v} + c\left(\frac{\partial^2 z}{\partial v^2} - \frac{\partial z}{\partial v}\right) = 0.$$

3492. $\frac{\partial^2 z}{\partial x^2} + \frac{\partial^2 z}{\partial y^2} = 0$, 设 $u = \frac{x}{x^2 + y^2}, v = -\frac{y}{x^2 + y^2}$.

解 $\frac{\partial z}{\partial x} = \frac{\partial z}{\partial u} \frac{\partial u}{\partial x} + \frac{\partial z}{\partial v} \frac{\partial v}{\partial x},$

$$\frac{\partial z}{\partial y} = \frac{\partial z}{\partial u} \frac{\partial u}{\partial y} + \frac{\partial z}{\partial v} \frac{\partial v}{\partial y},$$

$$\left\{ \begin{aligned} \frac{\partial^2 z}{\partial x^2} &= \frac{\partial^2 z}{\partial u^2} \left(\frac{\partial u}{\partial x} \right)^2 + 2 \frac{\partial^2 z}{\partial u \partial v} \frac{\partial u}{\partial x} \frac{\partial v}{\partial x} \\ &+ \frac{\partial^2 z}{\partial v^2} \left(\frac{\partial v}{\partial x} \right)^2 + \frac{\partial z}{\partial u} \frac{\partial^2 u}{\partial x^2} + \frac{\partial z}{\partial v} \frac{\partial^2 v}{\partial x^2}, \\ \frac{\partial^2 z}{\partial y^2} &= \frac{\partial^2 z}{\partial u^2} \left(\frac{\partial u}{\partial y} \right)^2 + 2 \frac{\partial^2 z}{\partial u \partial v} \frac{\partial u}{\partial y} \frac{\partial v}{\partial y} \\ &+ \frac{\partial^2 z}{\partial v^2} \left(\frac{\partial v}{\partial y} \right)^2 + \frac{\partial z}{\partial u} \frac{\partial^2 u}{\partial y^2} + \frac{\partial z}{\partial v} \frac{\partial^2 v}{\partial y^2}. \end{aligned} \right.$$

公式11

本题中,

$$\frac{\partial u}{\partial x} = \frac{y^2 - x^2}{(x^2 + y^2)^2}, \quad \frac{\partial v}{\partial x} = \frac{2xy}{(x^2 + y^2)^2},$$

$$\frac{\partial u}{\partial y} = -\frac{2xy}{(x^2 + y^2)^2} = -\frac{\partial v}{\partial x},$$

$$\frac{\partial v}{\partial y} = \frac{y^2 - x^2}{(x^2 + y^2)^2} = \frac{\partial u}{\partial x},$$

$$\frac{\partial^2 u}{\partial x^2} = \frac{\partial}{\partial x} \left(\frac{\partial v}{\partial y} \right) = \frac{\partial}{\partial y} \left(\frac{\partial v}{\partial x} \right)$$

$$= \frac{\partial}{\partial y} \left(-\frac{\partial u}{\partial y} \right) = -\frac{\partial^2 u}{\partial y^2},$$

同法可得

$$\frac{\partial^2 u}{\partial x \partial y} = -\frac{\partial^2 v}{\partial x^2} = \frac{\partial^2 v}{\partial y^2}.$$

注意到

$$\left(\frac{\partial u}{\partial x} \right)^2 + \left(\frac{\partial u}{\partial y} \right)^2 = \left(\frac{\partial v}{\partial x} \right)^2 + \left(\frac{\partial v}{\partial y} \right)^2,$$

$$\frac{\partial u}{\partial x} \frac{\partial v}{\partial x} = -\frac{\partial u}{\partial y} \frac{\partial v}{\partial y},$$

$$\frac{\partial^2 u}{\partial x^2} + \frac{\partial^2 u}{\partial y^2} = \frac{\partial^2 v}{\partial x^2} + \frac{\partial^2 v}{\partial y^2} = 0,$$

则由公式11, 即得

$$\frac{\partial^2 z}{\partial x^2} + \frac{\partial^2 z}{\partial y^2} = \left[\left(\frac{\partial u}{\partial x} \right)^2 + \left(\frac{\partial u}{\partial y} \right)^2 \right]$$

$$\cdot \left(\frac{\partial^2 z}{\partial u^2} + \frac{\partial^2 z}{\partial v^2} \right) = 0.$$

由于 $\left(\frac{\partial u}{\partial x} \right)^2 + \left(\frac{\partial u}{\partial y} \right)^2 \neq 0$, 故得变换后的方程

$$\frac{\partial^2 z}{\partial u^2} + \frac{\partial^2 z}{\partial v^2} = 0.$$

3493. $\frac{\partial^2 z}{\partial x^2} + \frac{\partial^2 z}{\partial y^2} + m^2 z = 0$, 设 $x = e^u \cos v, y = e^u \sin v$.

解 由于 $x = e^u \cos v, y = e^u \sin v$, 故有

$$x^2 + y^2 = e^{2u}, \quad u = \ln \sqrt{x^2 + y^2},$$

$$\operatorname{tg} v = \frac{y}{x}, \quad v = \operatorname{Arc} \operatorname{tg} \frac{y}{x} \quad (v \text{ 的多值性不影响求导}$$

所得的结果). 于是,

$$\frac{\partial u}{\partial x} = \frac{x}{x^2 + y^2} = \frac{\partial v}{\partial y},$$

$$\frac{\partial u}{\partial y} = \frac{y}{x^2 + y^2} = -\frac{\partial v}{\partial x}.$$

由 3492 题得

$$\begin{aligned}
& \frac{\partial^2 z}{\partial x^2} + \frac{\partial^2 z}{\partial y^2} + m^2 z = \left[\left(\frac{\partial u}{\partial x} \right)^2 + \left(\frac{\partial u}{\partial y} \right)^2 \right] \\
& \cdot \left(\frac{\partial^2 z}{\partial u^2} + \frac{\partial^2 z}{\partial v^2} \right) + m^2 z \\
& = \left[\frac{x^2}{(x^2 + y^2)^2} + \frac{y^2}{(x^2 + y^2)^2} \right] \\
& \cdot \left(\frac{\partial^2 z}{\partial u^2} + \frac{\partial^2 z}{\partial v^2} \right) + m^2 z \\
& = e^{-2u} \left(\frac{\partial^2 z}{\partial u^2} + \frac{\partial^2 z}{\partial v^2} \right) + m^2 z = 0,
\end{aligned}$$

即

$$\frac{\partial^2 z}{\partial u^2} + \frac{\partial^2 z}{\partial v^2} + m^2 e^{2u} z = 0.$$

3494. $\frac{\partial^2 z}{\partial x^2} - y \frac{\partial^2 z}{\partial y^2} = \frac{1}{2} \frac{\partial z}{\partial y}$ ($y > 0$), 设 $u = x - 2\sqrt{y}$ 及 $v = x + 2\sqrt{y}$.

解 $\frac{\partial u}{\partial x} = 1, \frac{\partial v}{\partial x} = 1, \frac{\partial u}{\partial y} = -\frac{1}{\sqrt{y}}, \frac{\partial v}{\partial y} = \frac{1}{\sqrt{y}},$

$$\frac{\partial^2 u}{\partial x^2} = \frac{\partial^2 v}{\partial x^2} = 0, \frac{\partial^2 u}{\partial y^2} = \frac{1}{2y^{\frac{3}{2}}},$$

$$\frac{\partial^2 v}{\partial y^2} = -\frac{1}{2y^{\frac{3}{2}}}.$$

由公式11得

$$\frac{\partial^2 z}{\partial x^2} = \frac{\partial^2 z}{\partial u^2} + 2 \frac{\partial^2 z}{\partial u \partial v} + \frac{\partial^2 z}{\partial v^2},$$

$$\frac{\partial^2 z}{\partial y^2} = \frac{1}{2y^{\frac{3}{2}}} \frac{\partial z}{\partial u} - \frac{1}{2y^{\frac{3}{2}}} \frac{\partial z}{\partial v} + \frac{1}{y} \frac{\partial^2 z}{\partial u^2}$$

$$- \frac{2}{y} \frac{\partial^2 z}{\partial u \partial v} + \frac{1}{y} \frac{\partial^2 z}{\partial v^2},$$

$$\frac{\partial z}{\partial y} = - \frac{1}{\sqrt{y}} \frac{\partial z}{\partial u} + \frac{1}{\sqrt{y}} \frac{\partial z}{\partial v}.$$

代入原方程，化简整理得

$$\frac{\partial^2 z}{\partial u \partial v} = 0.$$

3495. $x^2 \frac{\partial^2 z}{\partial x^2} - y^2 \frac{\partial^2 z}{\partial y^2} = 0$, 设 $u = xy$, $v = \frac{x}{y}$.

解 $\frac{\partial u}{\partial x} = y$, $\frac{\partial v}{\partial x} = \frac{1}{y}$, $\frac{\partial u}{\partial y} = x$,

$$\frac{\partial v}{\partial y} = -\frac{x}{y^2}, \quad \frac{\partial^2 u}{\partial x^2} = 0, \quad \frac{\partial^2 v}{\partial x^2} = 0,$$

$$\frac{\partial^2 u}{\partial y^2} = 0, \quad \frac{\partial^2 v}{\partial y^2} = \frac{2x}{y^3}.$$

由公式11得

$$\frac{\partial^2 z}{\partial x^2} = y^2 \frac{\partial^2 z}{\partial u^2} + 2 \frac{\partial^2 z}{\partial u \partial v} + \frac{1}{y^2} \frac{\partial^2 z}{\partial v^2},$$

$$\frac{\partial^2 z}{\partial y^2} = x^2 \frac{\partial^2 z}{\partial u^2} - \frac{2x^2}{y^2} \frac{\partial^2 z}{\partial u \partial v}$$

$$+ \frac{x^2}{y^4} \frac{\partial^2 z}{\partial v^2} + \frac{2x}{y^3} \frac{\partial z}{\partial v}.$$

代入原方程，化简整理得

$$\frac{\partial^2 z}{\partial u \partial v} = \frac{1}{2u} \frac{\partial z}{\partial v}.$$

$$3496. \quad x^2 \frac{\partial^2 z}{\partial x^2} - (x^2 + y^2) \frac{\partial^2 z}{\partial x \partial y} + y^2 \frac{\partial^2 z}{\partial y^2} = 0,$$

$$\text{设 } u = x + y, \quad v = \frac{1}{x} + \frac{1}{y}.$$

$$\text{解 } \frac{\partial z}{\partial x} = \frac{\partial z}{\partial u} - \frac{1}{x^2} \frac{\partial z}{\partial v}, \quad \frac{\partial z}{\partial y} = \frac{\partial z}{\partial u} - \frac{1}{y^2} \frac{\partial z}{\partial v}.$$

$$\frac{\partial^2 z}{\partial x^2} = \frac{\partial^2 z}{\partial u^2} - \frac{2}{x^2} \frac{\partial^2 z}{\partial u \partial v} + \frac{1}{x^4} \frac{\partial^2 z}{\partial v^2} + \frac{2}{x^3} \frac{\partial z}{\partial v},$$

$$\frac{\partial^2 z}{\partial y^2} = \frac{\partial^2 z}{\partial u^2} - \frac{2}{y^2} \frac{\partial^2 z}{\partial u \partial v} + \frac{1}{y^4} \frac{\partial^2 z}{\partial v^2} + \frac{2}{y^3} \frac{\partial z}{\partial v},$$

$$\frac{\partial^2 z}{\partial x \partial y} = \frac{\partial^2 z}{\partial u^2} - \left(\frac{1}{x^2} + \frac{1}{y^2} \right) \frac{\partial^2 z}{\partial u \partial v} + \frac{1}{x^2 y^2} \frac{\partial^2 z}{\partial v^2}.$$

代入原方程，得

$$\frac{(x^2 - y^2)^2}{x^2 y^2} \frac{\partial^2 z}{\partial u \partial v} + 2 \left(\frac{1}{x} + \frac{1}{y} \right) \frac{\partial z}{\partial v} = 0.$$

注意到 $v = \frac{1}{x} + \frac{1}{y} = \frac{x+y}{xy} = \frac{u}{xy}$ ，即 $xy = \frac{u}{v}$ ，于是

就有

$$\begin{aligned} \frac{(x^2 - y^2)^2}{x^2 y^2} &= \frac{(x+y)^2}{x^2 y^2} (x-y)^2 \\ &= \left(\frac{1}{x} + \frac{1}{y}\right)^2 [(x+y)^2 - 4xy] \\ &= v^2 \left(u^2 - 4\frac{u}{v}\right) = uv(uv - 4). \end{aligned}$$

从而得变换后的方程

$$\frac{\partial^2 z}{\partial u \partial v} = \frac{2}{u(4-uv)} \frac{\partial z}{\partial v}.$$

$$\begin{aligned} 3497. \quad xy \frac{\partial^2 z}{\partial x^2} - (x^2 + y^2) \frac{\partial^2 z}{\partial x \partial y} + xy \frac{\partial^2 z}{\partial y^2} + y \frac{\partial z}{\partial x} + x \frac{\partial z}{\partial y} \\ = 0, \quad \text{设 } u = \frac{1}{2}(x^2 + y^2) \text{ 及 } v = xy. \end{aligned}$$

$$\text{解} \quad \frac{\partial z}{\partial x} = x \frac{\partial z}{\partial u} + y \frac{\partial z}{\partial v}, \quad \frac{\partial z}{\partial y} = y \frac{\partial z}{\partial u} + x \frac{\partial z}{\partial v},$$

$$\frac{\partial^2 z}{\partial x^2} = x^2 \frac{\partial^2 z}{\partial u^2} + 2xy \frac{\partial^2 z}{\partial u \partial v} + y^2 \frac{\partial^2 z}{\partial v^2} + \frac{\partial z}{\partial u},$$

$$\frac{\partial^2 z}{\partial y^2} = y^2 \frac{\partial^2 z}{\partial u^2} + 2xy \frac{\partial^2 z}{\partial u \partial v} + x^2 \frac{\partial^2 z}{\partial v^2} + \frac{\partial z}{\partial u},$$

$$\frac{\partial^2 z}{\partial x \partial y} = xy \left(\frac{\partial^2 z}{\partial u^2} + \frac{\partial^2 z}{\partial v^2} \right) + (x^2 + y^2)$$

$$\cdot \frac{\partial^2 z}{\partial u \partial v} + \frac{\partial z}{\partial v}.$$

代入原方程，得

$$[(x^2 + y^2)^2 - 4x^2y^2] \frac{\partial^2 z}{\partial u \partial v} = 4xy \frac{\partial z}{\partial u},$$

即

$$(u^2 - v^2) \frac{\partial^2 z}{\partial u \partial v} = v \frac{\partial z}{\partial u}.$$

$$3498. \quad x^2 \frac{\partial^2 z}{\partial x^2} - 2x \sin y \frac{\partial^2 z}{\partial x \partial y} + \sin^2 y \frac{\partial^2 z}{\partial y^2} = 0,$$

$$\text{设 } u = x \operatorname{tg} \frac{y}{2}, \quad v = x.$$

$$\text{解 } \frac{\partial z}{\partial x} = \operatorname{tg} \frac{y}{2} \frac{\partial z}{\partial u} + \frac{\partial z}{\partial v}, \quad \frac{\partial z}{\partial y} = \frac{x}{2} \sec^2 \frac{y}{2} \frac{\partial z}{\partial u},$$

$$\frac{\partial^2 z}{\partial x^2} = \operatorname{tg}^2 \frac{y}{2} \frac{\partial^2 z}{\partial u^2} + 2 \operatorname{tg} \frac{y}{2} \frac{\partial^2 z}{\partial u \partial v} + \frac{\partial^2 z}{\partial v^2},$$

$$\frac{\partial^2 z}{\partial y^2} = \frac{x}{2} \sec^2 \frac{y}{2} \operatorname{tg} \frac{y}{2} \frac{\partial z}{\partial u} + \frac{x^2}{4} \sec^4 \frac{y}{2} \frac{\partial^2 z}{\partial u^2},$$

$$\frac{\partial^2 z}{\partial x \partial y} = \frac{1}{2} \sec^2 \frac{y}{2} \frac{\partial z}{\partial u} + \frac{x}{2} \sec^2 \frac{y}{2} \operatorname{tg} \frac{y}{2} \frac{\partial^2 z}{\partial u^2}$$

$$+ \frac{x}{2} \sec^2 \frac{y}{2} \frac{\partial^2 z}{\partial u \partial v}.$$

代入原方程，得

$$x^2 \frac{\partial^2 z}{\partial v^2} = \left(x \sin y \sec^2 \frac{y}{2} - \frac{x}{2} \sin^2 y \sec^2 \frac{y}{2} \operatorname{tg} \frac{y}{2} \right)$$

$$\cdot \frac{\partial z}{\partial u} = \left(2x \operatorname{tg} \frac{y}{2} - 2x \operatorname{tg} \frac{y}{2} \sin^2 \frac{y}{2} \right) \frac{\partial z}{\partial u}$$

$$= 2x \operatorname{tg} \frac{y}{2} \cos^2 \frac{y}{2} \frac{\partial z}{\partial u} = \frac{2x \operatorname{tg} \frac{y}{2}}{1 + \operatorname{tg}^2 \frac{y}{2}} \frac{\partial z}{\partial u},$$

即

$$\frac{\partial^2 z}{\partial v^2} = \frac{2u}{u^2 + v^2} \frac{\partial z}{\partial u}.$$

3499. $x \frac{\partial^2 z}{\partial x^2} - y \frac{\partial^2 z}{\partial y^2} = 0$ ($x > 0, y > 0$), 设 $x = (u+v)^2$

及 $y = (u-v)^2$.

解 由 $x = (u+v)^2$ 及 $y = (u-v)^2$ 分别对 x 及对 y 求偏导函数, 得

$$\begin{cases} 1 = 2(u+v) \left(\frac{\partial u}{\partial x} + \frac{\partial v}{\partial x} \right), \\ 0 = 2(u-v) \left(\frac{\partial u}{\partial x} - \frac{\partial v}{\partial x} \right); \end{cases}$$

$$\begin{cases} 0 = 2(u+v) \left(\frac{\partial u}{\partial y} + \frac{\partial v}{\partial y} \right), \\ 1 = 2(u-v) \left(\frac{\partial u}{\partial y} - \frac{\partial v}{\partial y} \right). \end{cases}$$

解得

$$\frac{\partial u}{\partial x} = \frac{\partial v}{\partial x} = \frac{1}{4(u+v)}, \quad \frac{\partial u}{\partial y} = -\frac{\partial v}{\partial y} = \frac{1}{4(u-v)}.$$

于是,

$$\frac{\partial z}{\partial x} = \frac{\partial z}{\partial u} \frac{\partial u}{\partial x} + \frac{\partial z}{\partial v} \frac{\partial v}{\partial x} = \frac{1}{4(u+v)} \left(\frac{\partial z}{\partial u} + \frac{\partial z}{\partial v} \right),$$

$$\frac{\partial z}{\partial y} = \frac{1}{4(u-v)} \left(\frac{\partial z}{\partial u} - \frac{\partial z}{\partial v} \right),$$

$$\frac{\partial^2 z}{\partial x^2} = -\frac{1}{4(u+v)^2} \left(\frac{\partial u}{\partial x} + \frac{\partial v}{\partial x} \right) \left(\frac{\partial z}{\partial u} + \frac{\partial z}{\partial v} \right)$$

$$+ \frac{1}{4(u+v)} \left(\frac{\partial^2 z}{\partial u^2} \frac{\partial u}{\partial x} + \frac{\partial^2 z}{\partial u \partial v} \frac{\partial v}{\partial x} \right)$$

$$+ \frac{\partial^2 z}{\partial u \partial v} \frac{\partial u}{\partial x} + \frac{\partial^2 z}{\partial v^2} \frac{\partial v}{\partial x}$$

$$= -\frac{1}{8(u+v)^2} \left(\frac{\partial z}{\partial u} + \frac{\partial z}{\partial v} \right) + \frac{1}{16(u+v)^2}$$

$$\cdot \left(\frac{\partial^2 z}{\partial u^2} + 2 \frac{\partial^2 z}{\partial u \partial v} + \frac{\partial^2 z}{\partial v^2} \right).$$

同法可求得

$$\frac{\partial^2 z}{\partial y^2} = -\frac{1}{8(u-v)^2} \left(\frac{\partial z}{\partial u} - \frac{\partial z}{\partial v} \right) + \frac{1}{16(u-v)^2}$$

$$\cdot \left(\frac{\partial^2 z}{\partial u^2} - 2 \frac{\partial^2 z}{\partial u \partial v} + \frac{\partial^2 z}{\partial v^2} \right).$$

代入原方程，得

$$x \frac{\partial^2 z}{\partial x^2} - y \frac{\partial^2 z}{\partial y^2} = -\frac{1}{8(u+v)} \left(\frac{\partial z}{\partial u} + \frac{\partial z}{\partial v} \right)$$

$$+ \frac{1}{16} \left(\frac{\partial^2 z}{\partial u^2} + 2 \frac{\partial^2 z}{\partial u \partial v} + \frac{\partial^2 z}{\partial v^2} \right)$$

$$\begin{aligned}
& + \frac{1}{8(u-v)} \left(\frac{\partial z}{\partial u} - \frac{\partial z}{\partial v} \right) \\
& - \frac{1}{16} \left(\frac{\partial^2 z}{\partial u^2} - 2 \frac{\partial^2 z}{\partial u \partial v} + \frac{\partial^2 z}{\partial v^2} \right) \\
& = \frac{1}{16} \left(\frac{4v}{u^2 - v^2} \frac{\partial z}{\partial u} - \frac{4u}{u^2 - v^2} \frac{\partial z}{\partial v} + 4 \frac{\partial^2 z}{\partial u \partial v} \right) = 0,
\end{aligned}$$

即

$$\frac{\partial^2 z}{\partial u \partial v} + \frac{1}{u^2 - v^2} \left(v \frac{\partial z}{\partial u} - u \frac{\partial z}{\partial v} \right) = 0.$$

3500. $\frac{\partial^2 z}{\partial x \partial y} = \left(1 + \frac{\partial z}{\partial y} \right)^3$, 设 $u = x$, $v = y + z$.

解 由 $u = x$, $v = y + z$ 得

$$du = dx, \quad dv = dy + dz,$$

$$dz = \frac{\partial z}{\partial u} du + \frac{\partial z}{\partial v} dv = \frac{\partial z}{\partial u} dx + \frac{\partial z}{\partial v} (dy + dz).$$

于是,

$$\left(1 - \frac{\partial z}{\partial v} \right) dz = \frac{\partial z}{\partial u} dx + \frac{\partial z}{\partial v} dy,$$

$$\frac{\partial z}{\partial x} = \frac{\frac{\partial z}{\partial u}}{1 - \frac{\partial z}{\partial v}}, \quad \frac{\partial z}{\partial y} = \frac{\frac{\partial z}{\partial v}}{1 - \frac{\partial z}{\partial v}}.$$

$$1 + \frac{\partial z}{\partial y} = 1 + \frac{\frac{\partial z}{\partial v}}{1 - \frac{\partial z}{\partial v}} = \frac{1}{1 - \frac{\partial z}{\partial v}}. \quad (1)$$

又

$$\begin{aligned}\frac{\partial^2 z}{\partial x \partial y} &= \frac{\partial}{\partial x} \left(1 + \frac{\partial z}{\partial y} \right) = \frac{\partial}{\partial x} \left(\frac{1}{1 - \frac{\partial z}{\partial v}} \right) \\ &= \frac{1}{\left(1 - \frac{\partial z}{\partial v} \right)^2} \frac{\partial}{\partial x} \left(\frac{\partial z}{\partial v} \right) \\ &= \frac{1}{\left(1 - \frac{\partial z}{\partial v} \right)^2} \left(\frac{\partial^2 z}{\partial u \partial v} \frac{\partial u}{\partial x} + \frac{\partial^2 z}{\partial v^2} \frac{\partial v}{\partial x} \right) \\ &= \frac{1}{\left(1 - \frac{\partial z}{\partial v} \right)^2} \left(\frac{\partial^2 z}{\partial u \partial v} + \frac{\partial^2 z}{\partial v^2} \frac{\partial z}{\partial x} \right) \\ &= \frac{1}{\left(1 - \frac{\partial z}{\partial v} \right)^3} \left[\frac{\partial^2 z}{\partial u \partial v} \left(1 - \frac{\partial z}{\partial v} \right) + \frac{\partial^2 z}{\partial v^2} \frac{\partial z}{\partial u} \right]. \quad (2)\end{aligned}$$

将 (1) 式和 (2) 式代入原方程, 去分母即得

$$\left(1 - \frac{\partial z}{\partial v} \right) \frac{\partial^2 z}{\partial u \partial v} + \frac{\partial z}{\partial u} \frac{\partial^2 z}{\partial v^2} = 1.$$

3501. 利用线性变换

$$\xi = x + \lambda_1 y, \quad \eta = x + \lambda_2 y$$

变换方程

$$A \frac{\partial^2 u}{\partial x^2} + 2B \frac{\partial^2 u}{\partial x \partial y} + C \frac{\partial^2 u}{\partial y^2} = 0, \quad (1)$$

(其中 A, B 和 C 为常数及 $C \neq 0, AC - B^2 < 0$)
为下面的形状

$$\frac{\partial^2 u}{\partial \xi \partial \eta} = 0.$$

求满足方程 (1) 的函数的普遍形状.

$$\text{解} \quad \frac{\partial u}{\partial x} = \frac{\partial u}{\partial \xi} + \frac{\partial u}{\partial \eta}, \quad \frac{\partial u}{\partial y} = \lambda_1 \frac{\partial u}{\partial \xi} + \lambda_2 \frac{\partial u}{\partial \eta},$$

$$\frac{\partial^2 u}{\partial x^2} = \frac{\partial^2 u}{\partial \xi^2} + 2 \frac{\partial^2 u}{\partial \xi \partial \eta} + \frac{\partial^2 u}{\partial \eta^2},$$

$$\frac{\partial^2 u}{\partial x \partial y} = \lambda_1 \frac{\partial^2 u}{\partial \xi^2} + (\lambda_1 + \lambda_2) \frac{\partial^2 u}{\partial \xi \partial \eta} + \lambda_2 \frac{\partial^2 u}{\partial \eta^2},$$

$$\frac{\partial^2 u}{\partial y^2} = \lambda_1^2 \frac{\partial^2 u}{\partial \xi^2} + 2\lambda_1 \lambda_2 \frac{\partial^2 u}{\partial \xi \partial \eta} + \lambda_2^2 \frac{\partial^2 u}{\partial \eta^2}.$$

将上述结果代入原方程, 得

$$\begin{aligned} & (A + 2B\lambda_1 + C\lambda_1^2) \frac{\partial^2 u}{\partial \xi^2} + 2(A + B(\lambda_1 + \lambda_2) \\ & + C\lambda_1 \lambda_2) \frac{\partial^2 u}{\partial \xi \partial \eta} + (A + 2B\lambda_2 + C\lambda_2^2) \frac{\partial^2 u}{\partial \eta^2} = 0. \end{aligned}$$

当 $A + 2B\lambda_1 + C\lambda_1^2 = 0$ 及 $A + 2B\lambda_2 + C\lambda_2^2 = 0$. 即 λ_1 与 λ_2 为方程

$$A + 2B\lambda + C\lambda^2 = 0$$

的根时 (注意, 由假定 $C \neq 0$, $AC - B^2 < 0$, 故此方程恰有两个相异的实根), 原方程变换为

$$(A + B(\lambda_1 + \lambda_2) + C\lambda_1 \lambda_2) \frac{\partial^2 u}{\partial \xi \partial \eta} = 0.$$

由根与系数的关系得: $\lambda_1 + \lambda_2 = -\frac{2B}{C}$, $\lambda_1 \lambda_2 = \frac{A}{C}$.

于是,

$$A + B(\lambda_1 + \lambda_2) + C\lambda_1\lambda_2 = \frac{2(AC - B^2)}{C} \neq 0.$$

从而必有

$$\frac{\partial^2 u}{\partial \xi \partial \eta} = 0.$$

此时, $\frac{\partial^2 u}{\partial \xi \partial \eta} = \frac{\partial}{\partial \eta} \left(\frac{\partial u}{\partial \xi} \right) = 0$, 故 $\frac{\partial u}{\partial \xi} = f(\xi)$ 且

$$\begin{aligned} u &= \int f(\xi) d\xi + \psi(\eta) = \varphi(\xi) + \psi(\eta) \\ &= \varphi(x + \lambda_1 y) + \psi(x + \lambda_2 y). \end{aligned}$$

3502. 证明拉普拉斯方程

$$\Delta z = \frac{\partial^2 z}{\partial x^2} + \frac{\partial^2 z}{\partial y^2} = 0$$

在满足条件 $\frac{\partial \varphi}{\partial u} = \frac{\partial \psi}{\partial v}$, $\frac{\partial \varphi}{\partial v} = -\frac{\partial \psi}{\partial u}$

的非退化的变数代换

$$x = \varphi(u, v), \quad y = \psi(u, v)$$

下形式不变.

$$\text{证} \quad \begin{cases} dx = \frac{\partial \varphi}{\partial u} du + \frac{\partial \varphi}{\partial v} dv, \\ dy = \frac{\partial \psi}{\partial u} du + \frac{\partial \psi}{\partial v} dv = -\frac{\partial \varphi}{\partial v} du + \frac{\partial \varphi}{\partial u} dv. \end{cases}$$

令 $I = \left(\frac{\partial \varphi}{\partial u} \right)^2 + \left(\frac{\partial \varphi}{\partial v} \right)^2$. 由于变换是非退化的, 故知

$$\frac{D(x, y)}{D(u, v)} = \begin{vmatrix} \frac{\partial \varphi}{\partial u} & \frac{\partial \varphi}{\partial v} \\ \frac{\partial \psi}{\partial u} & \frac{\partial \psi}{\partial v} \end{vmatrix} = \left(\frac{\partial \varphi}{\partial u}\right)^2 + \left(\frac{\partial \varphi}{\partial v}\right)^2 = I \neq 0.$$

由上述方程组解得

$$du = \frac{1}{I} \left(\frac{\partial \varphi}{\partial u} dx - \frac{\partial \varphi}{\partial v} dy \right),$$

$$dv = \frac{1}{I} \left(\frac{\partial \varphi}{\partial v} dx + \frac{\partial \varphi}{\partial u} dy \right).$$

于是,

$$\frac{\partial u}{\partial x} = \frac{1}{I} \frac{\partial \varphi}{\partial u} = \frac{\partial v}{\partial y}, \quad \frac{\partial u}{\partial y} = -\frac{1}{I} \frac{\partial \varphi}{\partial v} = -\frac{\partial v}{\partial x}.$$

由3492题的证明及公式11, 并考虑到

$$\left(\frac{\partial u}{\partial x}\right)^2 + \left(\frac{\partial u}{\partial y}\right)^2 = \frac{1}{I^2} \left[\left(\frac{\partial \varphi}{\partial u}\right)^2 + \left(\frac{\partial \varphi}{\partial v}\right)^2 \right] = \frac{1}{I},$$

即得

$$\begin{aligned} \Delta z &\equiv \frac{\partial^2 z}{\partial x^2} + \frac{\partial^2 z}{\partial y^2} \\ &= \left[\left(\frac{\partial u}{\partial x}\right)^2 + \left(\frac{\partial u}{\partial y}\right)^2 \right] \left(\frac{\partial^2 z}{\partial u^2} + \frac{\partial^2 z}{\partial v^2} \right) \\ &= \frac{1}{I} \left(\frac{\partial^2 z}{\partial u^2} + \frac{\partial^2 z}{\partial v^2} \right) = 0, \end{aligned}$$

或

$$\frac{\partial^2 z}{\partial u^2} + \frac{\partial^2 z}{\partial v^2} = 0,$$

即形式是不变的.

3503. 假定 $u=f(r)$, 其中 $r=\sqrt{x^2+y^2}$, 改变方程

$$(a) \Delta u = \frac{\partial^2 u}{\partial x^2} + \frac{\partial^2 u}{\partial y^2} = 0; \quad (b) \Delta(\Delta u) = 0.$$

解 (a) $\frac{\partial u}{\partial x} = f'(r) \frac{\partial r}{\partial x} = f'(r) \frac{x}{r}, \quad \frac{\partial u}{\partial y} = f'(r) \frac{y}{r}.$

于是,

$$\begin{aligned} \frac{\partial^2 u}{\partial x^2} &= \frac{\partial}{\partial x} \left[f'(r) \frac{x}{r} \right] = \frac{f'(r)}{r} \\ &\quad + \frac{x^2}{r^2} f''(r) + x f'(r) \cdot \left(-\frac{x}{r^3} \right) \\ &= \frac{x^2}{r^2} f''(r) + \frac{y^2}{r^3} f'(r). \end{aligned}$$

同法可得

$$\frac{\partial^2 u}{\partial y^2} = \frac{y^2}{r^2} f''(r) + \frac{x^2}{r^3} f'(r).$$

于是,

$$\Delta u = f''(r) + \frac{1}{r} f'(r) = \frac{d^2 u}{dr^2} + \frac{1}{r} \frac{du}{dr} = 0,$$

也可写成 $\Delta u = \frac{1}{r} \frac{d}{dr} \left(r \frac{du}{dr} \right) = 0.$

$$\begin{aligned}
(6) \quad \Delta(\Delta u) &= \frac{1}{r} \frac{d}{dr} \left[r \frac{d}{dr} (\Delta u) \right] \\
&= \frac{1}{r} \frac{d}{dr} \left[r \frac{d}{dr} \left(\frac{d^2 u}{dr^2} + \frac{1}{r} \frac{du}{dr} \right) \right] \\
&= \frac{1}{r} \frac{d}{dr} \left[r \frac{d^3 u}{dr^3} + \frac{d^2 u}{dr^2} - \frac{1}{r} \frac{du}{dr} \right] \\
&= \frac{d^4 u}{dr^4} + \frac{2}{r} \frac{d^3 u}{dr^3} - \frac{1}{r^2} \frac{d^2 u}{dr^2} + \frac{1}{r^3} \frac{du}{dr} = 0.
\end{aligned}$$

3504. 若令

$$w = f(u),$$

其中

$$u = (x - x_0)(y - y_0),$$

方程

$$\frac{\partial^2 w}{\partial x \partial y} + cw = 0$$

变成怎样的形状?

解 $\frac{\partial w}{\partial x} = (y - y_0) \frac{dw}{du}, \quad \frac{\partial^2 w}{\partial x \partial y} = \frac{dw}{du} + u \frac{d^2 w}{du^2}.$ 于

是, 方程 $\frac{\partial^2 w}{\partial x \partial y} + cw = 0$ 变换成

$$u \frac{d^2 w}{du^2} + \frac{dw}{du} + cw = 0.$$

3505. 假定

$$x + y = X, \quad y = XY,$$

变换式子 $A = x \frac{\partial^2 u}{\partial x^2} + y \frac{\partial^2 u}{\partial x \partial y} + \frac{\partial u}{\partial x}.$

解 $X = x + y$, $Y = \frac{y}{X} = \frac{y}{x+y} = 1 - \frac{x}{x+y}$. 于

$$\text{是, } \frac{\partial X}{\partial x} = 1, \frac{\partial X}{\partial y} = 1, \frac{\partial Y}{\partial x} = -\frac{y}{(x+y)^2},$$

$$\frac{\partial Y}{\partial y} = \frac{x}{(x+y)^2},$$

$$\frac{\partial u}{\partial x} = \frac{\partial u}{\partial X} - \frac{y}{(x+y)^2} \frac{\partial u}{\partial Y},$$

$$\frac{\partial^2 u}{\partial x^2} = \frac{\partial^2 u}{\partial X^2} - \frac{2y}{(x+y)^2} \frac{\partial^2 u}{\partial X \partial Y}$$

$$+ \frac{y^2}{(x+y)^4} \frac{\partial^2 u}{\partial Y^2} + \frac{2y}{(x+y)^3} \frac{\partial u}{\partial Y},$$

$$\frac{\partial^2 u}{\partial x \partial y} = \frac{\partial^2 u}{\partial X^2} + \frac{x-y}{(x+y)^2} \frac{\partial^2 u}{\partial X \partial Y}$$

$$- \frac{xy}{(x+y)^4} \frac{\partial^2 u}{\partial Y^2} - \frac{x-y}{(x+y)^3} \frac{\partial u}{\partial Y}.$$

代入所给式子, 得

$$A = X \frac{\partial^2 u}{\partial X^2} - Y \frac{\partial^2 u}{\partial X \partial Y} + \frac{\partial u}{\partial X}.$$

3506. 证明: 方程

$$\frac{\partial^2 z}{\partial x^2} + 2xy^2 \frac{\partial z}{\partial x} + 2(y-y^3) \frac{\partial z}{\partial y} + x^2 y^2 z^2 = 0$$

在变换 $x=uv$ 及 $y=\frac{1}{v}$

下形状不变.

证 $v=\frac{1}{y}$, $u=\frac{x}{v}=xy$. 于是,

$$\frac{\partial z}{\partial x} = \frac{\partial z}{\partial u} \frac{\partial u}{\partial x} + \frac{\partial z}{\partial v} \frac{\partial v}{\partial x} = y \frac{\partial z}{\partial u},$$

$$\frac{\partial z}{\partial y} = \frac{\partial z}{\partial u} \frac{\partial u}{\partial y} + \frac{\partial z}{\partial v} \frac{\partial v}{\partial y} = x \frac{\partial z}{\partial u} - \frac{1}{y^2} \frac{\partial z}{\partial v},$$

$$\frac{\partial^2 z}{\partial x^2} = \frac{\partial}{\partial x} \left(\frac{\partial z}{\partial x} \right) = \frac{\partial}{\partial x} \left(y \frac{\partial z}{\partial u} \right) = y^2 \frac{\partial^2 z}{\partial u^2}.$$

代入原方程, 得

$$y^2 \frac{\partial^2 z}{\partial u^2} + 2xy^3 \frac{\partial z}{\partial u} + 2x(y-y^3) \frac{\partial z}{\partial v} - 2(y-y^3)$$

$$\cdot \frac{1}{y^2} \frac{\partial z}{\partial v} + x^2 y^2 z^2 = 0,$$

即

$$\frac{\partial^2 z}{\partial u^2} + 2uv^2 \frac{\partial z}{\partial u} + 2(v-v^3) \frac{\partial z}{\partial v} + u^2 v^2 z^2 = 0,$$

故其形状不变.

3507. 证明: 方程

$$\frac{\partial^2 z}{\partial x^2} + 2 \frac{\partial^2 z}{\partial x \partial y} + \frac{\partial^2 z}{\partial y^2} = 0$$

在变换 $u = x + z$ 及 $v = y + z$

下形状不变。

证 将 u, v 作中间变量, x, y 作自变量。微分得

$$du = dx + dz, \quad dv = dy + dz, \quad d^2u = d^2v = d^2z.$$

于是,

$$\begin{aligned} dz &= \frac{\partial z}{\partial u} du + \frac{\partial z}{\partial v} dv = \left(\frac{\partial z}{\partial u} + \frac{\partial z}{\partial v} \right) dz \\ &\quad + \frac{\partial z}{\partial u} dx + \frac{\partial z}{\partial v} dy. \end{aligned}$$

令 $A = 1 - \frac{\partial z}{\partial u} - \frac{\partial z}{\partial v}$, 则有 $dz = \frac{1}{A} \frac{\partial z}{\partial u} dx + \frac{1}{A} \frac{\partial z}{\partial v} dy$, 且

$$\frac{\partial z}{\partial x} = \frac{1}{A} \frac{\partial z}{\partial u}, \quad \frac{\partial z}{\partial y} = \frac{1}{A} \frac{\partial z}{\partial v}.$$

从而有

$$du = dx + dz = \frac{1 - \frac{\partial z}{\partial v}}{A} dx + \frac{\frac{\partial z}{\partial v}}{A} dy,$$

$$dv = dy + dz = \frac{\frac{\partial z}{\partial u}}{A} dx + \frac{1 - \frac{\partial z}{\partial u}}{A} dy,$$

$$\begin{aligned} d^2z &= \frac{\partial^2 z}{\partial u^2} du^2 + 2 \frac{\partial^2 z}{\partial u \partial v} dudv + \frac{\partial^2 z}{\partial v^2} dv^2 \\ &\quad + \frac{\partial z}{\partial u} d^2u + \frac{\partial z}{\partial v} d^2v. \end{aligned}$$

上面最后一个等式即

$$\begin{aligned}
 Ad^2z &= \frac{1}{A^2} \left\{ \frac{\partial^2 z}{\partial u^2} \left[\left(1 - \frac{\partial z}{\partial v} \right) dx + \frac{\partial z}{\partial v} dy \right]^2 \right. \\
 &+ 2 \frac{\partial^2 z}{\partial u \partial v} \left[\left(1 - \frac{\partial z}{\partial v} \right) dx + \frac{\partial z}{\partial v} dy \right] \\
 &\cdot \left[\frac{\partial z}{\partial u} dx + \left(1 - \frac{\partial z}{\partial u} \right) dy \right] + \frac{\partial^2 z}{\partial v^2} \left[\frac{\partial z}{\partial u} dx \right. \\
 &\left. \left. + \left(1 - \frac{\partial z}{\partial u} \right) dy \right]^2 \right\}.
 \end{aligned}$$

于是,

$$\begin{aligned}
 \frac{\partial^2 z}{\partial x^2} &= \frac{1}{A^3} \left[\left(1 - \frac{\partial z}{\partial v} \right)^2 \frac{\partial^2 z}{\partial u^2} + 2 \left(1 - \frac{\partial z}{\partial v} \right) \right. \\
 &\cdot \left. \frac{\partial z}{\partial u} \frac{\partial^2 z}{\partial u \partial v} + \left(\frac{\partial z}{\partial u} \right)^2 \frac{\partial^2 z}{\partial u^2} \right], \\
 \frac{\partial^2 z}{\partial x \partial y} &= \frac{1}{A^3} \left[\frac{\partial z}{\partial v} \left(1 - \frac{\partial z}{\partial v} \right) \frac{\partial^2 z}{\partial u^2} + \frac{\partial z}{\partial u} \frac{\partial z}{\partial v} \frac{\partial^2 z}{\partial u \partial v} \right. \\
 &+ \left(1 - \frac{\partial z}{\partial u} \right) \left(1 - \frac{\partial z}{\partial v} \right) \frac{\partial^2 z}{\partial u \partial v} \\
 &\left. + \frac{\partial z}{\partial u} \left(1 - \frac{\partial z}{\partial u} \right) \frac{\partial^2 z}{\partial v^2} \right], \\
 \frac{\partial^2 z}{\partial y^2} &= \frac{1}{A^3} \left[\left(\frac{\partial z}{\partial v} \right)^2 \frac{\partial^2 z}{\partial u^2} + 2 \frac{\partial z}{\partial v} \left(1 - \frac{\partial z}{\partial u} \right) \right. \\
 &\cdot \left. \frac{\partial^2 z}{\partial u \partial v} + \left(1 - \frac{\partial z}{\partial u} \right)^2 \frac{\partial^2 z}{\partial v^2} \right].
 \end{aligned}$$

代入原方程，化简整理即得

$$\frac{\partial^2 z}{\partial u^2} + 2 \frac{\partial^2 z}{\partial u \partial v} + \frac{\partial^2 z}{\partial v^2} = 0,$$

故其形状不变。

3508. 假定

$$x = \eta \zeta, \quad y = \xi \zeta, \quad z = \xi \eta,$$

变换方程 $xy \frac{\partial^2 u}{\partial x \partial y} + yz \frac{\partial^2 u}{\partial y \partial z} + xz \frac{\partial^2 u}{\partial x \partial z} = 0.$

解 由于

$$\begin{cases} 1 = \zeta \frac{\partial \eta}{\partial x} + \eta \frac{\partial \zeta}{\partial x}, \\ 0 = \zeta \frac{\partial \xi}{\partial x} + \xi \frac{\partial \zeta}{\partial x}, \\ 0 = \eta \frac{\partial \xi}{\partial x} + \xi \frac{\partial \eta}{\partial x}, \end{cases}$$

故有

$$\frac{\partial \xi}{\partial x} = -\frac{\xi}{2\eta\zeta}, \quad \frac{\partial \eta}{\partial x} = \frac{1}{2\zeta}, \quad \frac{\partial \zeta}{\partial x} = \frac{1}{2\eta}.$$

同法求得

$$\frac{\partial \xi}{\partial y} = \frac{1}{2\zeta}, \quad \frac{\partial \eta}{\partial y} = -\frac{\eta}{2\xi\zeta}, \quad \frac{\partial \zeta}{\partial y} = \frac{1}{2\xi}.$$

于是，

$$\frac{\partial u}{\partial x} = \frac{\partial u}{\partial \xi} \frac{\partial \xi}{\partial x} + \frac{\partial u}{\partial \eta} \frac{\partial \eta}{\partial x} + \frac{\partial u}{\partial \zeta} \frac{\partial \zeta}{\partial x}$$

$$\begin{aligned}
&= -\frac{\xi}{2\eta\zeta} \frac{\partial u}{\partial \xi} + \frac{1}{2\zeta} \frac{\partial u}{\partial \eta} + \frac{1}{2\eta} \frac{\partial u}{\partial \zeta}, \\
\frac{\partial^2 u}{\partial x \partial y} &= \frac{\partial}{\partial y} \left(\frac{\partial u}{\partial x} \right) = -\frac{\partial}{\partial y} \left(\frac{\xi}{2\eta\zeta} \right) \frac{\partial u}{\partial \xi} \\
&\quad - \frac{\xi}{2\eta\zeta} \frac{\partial}{\partial y} \left(\frac{\partial u}{\partial \xi} \right) + \frac{\partial}{\partial y} \left(\frac{1}{2\zeta} \right) \frac{\partial u}{\partial \eta} \\
&\quad + \frac{1}{2\zeta} \frac{\partial}{\partial y} \left(\frac{\partial u}{\partial \eta} \right) + \frac{\partial}{\partial y} \left(\frac{1}{2\eta} \right) \frac{\partial u}{\partial \zeta} + \frac{1}{2\eta} \frac{\partial}{\partial y} \left(\frac{\partial u}{\partial \zeta} \right) \\
&= -\frac{1}{4\eta\zeta^2} \frac{\partial u}{\partial \xi} - \frac{\xi}{4\eta\zeta^2} \frac{\partial^2 u}{\partial \xi^2} \\
&\quad - \frac{1}{4\xi\zeta^2} \frac{\partial u}{\partial \eta} - \frac{\eta}{4\xi\zeta^2} \frac{\partial^2 u}{\partial \eta^2} \\
&\quad + \frac{1}{4\xi\eta\zeta} \frac{\partial u}{\partial \zeta} + \frac{1}{4\xi\eta} \frac{\partial^2 u}{\partial \zeta^2} + \frac{1}{2\zeta^2} \frac{\partial^2 u}{\partial \xi \partial \eta}. \quad (1)
\end{aligned}$$

同法可求得

$$\begin{aligned}
\frac{\partial^2 u}{\partial y \partial z} &= \frac{1}{4\xi\eta\zeta} \frac{\partial u}{\partial \xi} + \frac{1}{4\eta\zeta} \frac{\partial^2 u}{\partial \xi^2} \\
&\quad - \frac{1}{4\xi^2\zeta} \frac{\partial u}{\partial \eta} - \frac{\eta}{4\xi^2\zeta} \frac{\partial^2 u}{\partial \eta^2} \\
&\quad - \frac{1}{4\xi^2\eta} \frac{\partial u}{\partial \zeta} - \frac{\zeta}{4\xi^2\eta} \frac{\partial^2 u}{\partial \zeta^2} + \frac{1}{2\xi^2} \frac{\partial^2 u}{\partial \eta \partial \zeta}, \quad (2) \\
\frac{\partial^2 u}{\partial z \partial x} &= -\frac{1}{4\eta^2\zeta} \frac{\partial u}{\partial \xi} - \frac{\xi}{4\eta^2\zeta} \frac{\partial^2 u}{\partial \xi^2}
\end{aligned}$$

$$\begin{aligned}
& + \frac{1}{4\xi\eta\zeta} \frac{\partial u}{\partial \eta} + \frac{1}{4\xi\zeta} \frac{\partial^2 u}{\partial \eta^2} \\
& - \frac{1}{4\eta^2\xi} \frac{\partial u}{\partial \zeta} - \frac{\zeta}{4\eta^2\xi} \frac{\partial^2 u}{\partial \zeta^2} + \frac{1}{2\eta^2} \frac{\partial^2 u}{\partial \zeta \partial \xi}. \quad (3)
\end{aligned}$$

將(1), (2), (3) 三式连同 x, y, z 一起代入原方程, 化简整理得

$$\begin{aligned}
& \xi \frac{\partial u}{\partial \xi} + \eta \frac{\partial u}{\partial \eta} + \zeta \frac{\partial u}{\partial \zeta} + \xi^2 \frac{\partial^2 u}{\partial \xi^2} + \eta^2 \frac{\partial^2 u}{\partial \eta^2} + \zeta^2 \frac{\partial^2 u}{\partial \zeta^2} \\
& = 2 \left(\xi \eta \frac{\partial^2 u}{\partial \xi \partial \eta} + \eta \zeta \frac{\partial^2 u}{\partial \eta \partial \zeta} + \zeta \xi \frac{\partial^2 u}{\partial \zeta \partial \xi} \right),
\end{aligned}$$

即

$$\begin{aligned}
& \xi \frac{\partial}{\partial \xi} \left(\xi \frac{\partial u}{\partial \xi} \right) + \eta \frac{\partial}{\partial \eta} \left(\eta \frac{\partial u}{\partial \eta} \right) + \zeta \frac{\partial}{\partial \zeta} \left(\zeta \frac{\partial u}{\partial \zeta} \right) \\
& = 2 \left(\xi \eta \frac{\partial^2 u}{\partial \xi \partial \eta} + \eta \zeta \frac{\partial^2 u}{\partial \eta \partial \zeta} + \zeta \xi \frac{\partial^2 u}{\partial \zeta \partial \xi} \right).
\end{aligned}$$

3509. 假定

$$y_1 = x_2 + x_3 - x_1, \quad y_2 = x_1 + x_3 - x_2,$$

$$y_3 = x_1 + x_2 - x_3,$$

变换方程

$$\begin{aligned}
& \frac{\partial^2 z}{\partial x_1^2} + \frac{\partial^2 z}{\partial x_2^2} + \frac{\partial^2 z}{\partial x_3^2} + \frac{\partial^2 z}{\partial x_1 \partial x_2} \\
& + \frac{\partial^2 z}{\partial x_1 \partial x_3} + \frac{\partial^2 z}{\partial x_2 \partial x_3} = 0.
\end{aligned}$$

解 不难看出

$$\frac{\partial z}{\partial x_1} = \left(-\frac{\partial}{\partial y_1} + \frac{\partial}{\partial y_2} + \frac{\partial}{\partial y_3} \right) z,$$

$$\frac{\partial z}{\partial x_2} = \left(\frac{\partial}{\partial y_1} - \frac{\partial}{\partial y_2} + \frac{\partial}{\partial y_3} \right) z,$$

$$\frac{\partial z}{\partial x_3} = \left(\frac{\partial}{\partial y_1} + \frac{\partial}{\partial y_2} - \frac{\partial}{\partial y_3} \right) z.$$

把上述结果代入所给方程的左端，即得

$$\begin{aligned} & \frac{\partial^2 z}{\partial x_1^2} + \frac{\partial^2 z}{\partial x_2^2} + \frac{\partial^2 z}{\partial x_3^2} + \frac{\partial^2 z}{\partial x_1 \partial x_2} \\ & + \frac{\partial^2 z}{\partial x_1 \partial x_3} + \frac{\partial^2 z}{\partial x_2 \partial x_3} \\ & = \frac{\partial}{\partial x_1} \left(\frac{\partial z}{\partial x_1} + \frac{\partial z}{\partial x_2} \right) + \frac{\partial}{\partial x_2} \left(\frac{\partial z}{\partial x_2} + \frac{\partial z}{\partial x_3} \right) \\ & + \frac{\partial}{\partial x_3} \left(\frac{\partial z}{\partial x_3} + \frac{\partial z}{\partial x_1} \right) \\ & = \frac{\partial}{\partial x_1} \left(2 \frac{\partial z}{\partial y_3} \right) + \frac{\partial}{\partial x_2} \left(2 \frac{\partial z}{\partial y_1} \right) \\ & + \frac{\partial}{\partial x_3} \left(2 \frac{\partial z}{\partial y_2} \right) \\ & = 2 \left[\left(-\frac{\partial}{\partial y_1} + \frac{\partial}{\partial y_2} + \frac{\partial}{\partial y_3} \right) \frac{\partial z}{\partial y_3} \right. \\ & \left. + \left(\frac{\partial}{\partial y_1} - \frac{\partial}{\partial y_2} + \frac{\partial}{\partial y_3} \right) \frac{\partial z}{\partial y_1} \right] \end{aligned}$$

$$\begin{aligned}
& + \left(\frac{\partial}{\partial y_1} + \frac{\partial}{\partial y_2} - \frac{\partial}{\partial y_3} \right) \frac{\partial z}{\partial y_2} \Big] \\
& = 2 \left(\frac{\partial^2 z}{\partial y_1^2} + \frac{\partial^2 z}{\partial y_2^2} + \frac{\partial^2 z}{\partial y_3^2} \right).
\end{aligned}$$

从而原方程变换为

$$\frac{\partial^2 z}{\partial y_1^2} + \frac{\partial^2 z}{\partial y_2^2} + \frac{\partial^2 z}{\partial y_3^2} = 0.$$

3510. 假定

$$\xi = \frac{y}{x}, \eta = \frac{z}{x}, \zeta = y - z,$$

变换方程

$$\begin{aligned}
& x^2 \frac{\partial^2 u}{\partial x^2} + y^2 \frac{\partial^2 u}{\partial y^2} + z^2 \frac{\partial^2 u}{\partial z^2} + 2xy \frac{\partial^2 u}{\partial x \partial y} \\
& + 2xz \frac{\partial^2 u}{\partial x \partial z} + 2yz \frac{\partial^2 u}{\partial y \partial z} = 0.
\end{aligned}$$

解 定义算子 A :

$$Au = \left(x \frac{\partial}{\partial x} + y \frac{\partial}{\partial y} + z \frac{\partial}{\partial z} \right) u,$$

则有

$$\begin{aligned}
A^2 u &= A(Au) = x \frac{\partial}{\partial x} (Au) + y \frac{\partial}{\partial y} (Au) \\
& + z \frac{\partial}{\partial z} (Au)
\end{aligned}$$

$$\begin{aligned}
&= x \left(x \frac{\partial^2}{\partial x^2} + y \frac{\partial^2}{\partial x \partial y} + z \frac{\partial^2}{\partial x \partial z} + \frac{\partial}{\partial x} \right) u \\
&\quad + y \left(x \frac{\partial^2}{\partial x \partial y} + y \frac{\partial^2}{\partial y^2} + z \frac{\partial^2}{\partial y \partial z} + \frac{\partial}{\partial y} \right) u \\
&\quad + z \left(x \frac{\partial^2}{\partial x \partial z} + y \frac{\partial^2}{\partial y \partial z} + z \frac{\partial^2}{\partial z^2} + \frac{\partial}{\partial z} \right) u, \\
&= \left(x \frac{\partial}{\partial x} + y \frac{\partial}{\partial y} + z \frac{\partial}{\partial z} \right)^2 u + Au.
\end{aligned}$$

于是，原方程可改写成

$$\left(x \frac{\partial}{\partial x} + y \frac{\partial}{\partial y} + z \frac{\partial}{\partial z} \right)^2 u = 0 \quad \text{或} \quad A^2 u - Au = 0.$$

但是，

$$\begin{aligned}
Au &= x \frac{\partial u}{\partial x} + y \frac{\partial u}{\partial y} + z \frac{\partial u}{\partial z} \\
&= x \left(-\frac{y}{x^2} \frac{\partial u}{\partial \xi} - \frac{z}{x^2} \frac{\partial u}{\partial \eta} \right) + y \left(\frac{1}{x} \frac{\partial u}{\partial \xi} + \frac{\partial u}{\partial \zeta} \right) \\
&\quad + z \left(\frac{1}{x} \frac{\partial u}{\partial \eta} - \frac{\partial u}{\partial \zeta} \right) \\
&= (y - z) \frac{\partial u}{\partial \zeta} = \zeta \frac{\partial u}{\partial \zeta},
\end{aligned}$$

$$\begin{aligned}
A^2 u &= A(Au) = \left(\zeta \frac{\partial}{\partial \zeta} \right) Au = \zeta \frac{\partial}{\partial \zeta} \left(\zeta \frac{\partial u}{\partial \zeta} \right) \\
&= \zeta^2 \frac{\partial^2 u}{\partial \zeta^2} + \zeta \frac{\partial u}{\partial \zeta},
\end{aligned}$$

从而 $A^2u - Au = \xi^2 \frac{\partial^2 u}{\partial \xi^2}$. 由于 $\xi \neq 0$, 故原方程

变换为

$$\frac{\partial^2 u}{\partial \xi^2} = 0.$$

3511. 假定

$$x = r \sin \theta \cos \varphi, \quad y = r \sin \theta \sin \varphi, \quad z = r \cos \theta,$$

$$\Delta_1 u = \left(\frac{\partial u}{\partial x} \right)^2 + \left(\frac{\partial u}{\partial y} \right)^2 + \left(\frac{\partial u}{\partial z} \right)^2$$

$$\text{及} \quad \Delta_2 u = \frac{\partial^2 u}{\partial x^2} + \frac{\partial^2 u}{\partial y^2} + \frac{\partial^2 u}{\partial z^2}$$

为球坐标所表的式子。

解 先作变换

$$x = R \cos \varphi, \quad y = R \sin \varphi, \quad z = z,$$

它相当于对 x, y 坐标作一次极坐标变换。

利用 3483 题及 3484 题的结果, 对新变元 R, φ, z 有

$$\begin{aligned} \Delta_1 u &= \left(\frac{\partial u}{\partial x} \right)^2 + \left(\frac{\partial u}{\partial y} \right)^2 + \left(\frac{\partial u}{\partial z} \right)^2 \\ &= \left(\frac{\partial u}{\partial R} \right)^2 + \frac{1}{R^2} \left(\frac{\partial u}{\partial \varphi} \right)^2 + \left(\frac{\partial u}{\partial z} \right)^2, \end{aligned}$$

$$\begin{aligned} \Delta_2 u &= \frac{\partial^2 u}{\partial x^2} + \frac{\partial^2 u}{\partial y^2} + \frac{\partial^2 u}{\partial z^2} \\ &= \frac{\partial^2 u}{\partial R^2} + \frac{1}{R^2} \frac{\partial^2 u}{\partial \varphi^2} + \frac{1}{R} \frac{\partial u}{\partial R} + \frac{\partial^2 u}{\partial z^2}. \end{aligned}$$

再作变换

$$R = r \sin \theta, \quad \varphi = \varphi, \quad z = r \cos \theta.$$

它相当于对 R, z 坐标又作一次极坐标变换, 其中 R 相当于公式 9 中的 y , θ 相当于公式 9 中的 φ . 于是,

$$\frac{\partial u}{\partial R} = \frac{R}{r} \frac{\partial u}{\partial r} + \frac{z}{r^2} \frac{\partial u}{\partial \varphi} = \sin \theta \frac{\partial u}{\partial r} + \frac{\cos \theta}{r} \frac{\partial u}{\partial \theta}.$$

再利用 3483 题及 3484 题的结果, 得

$$\begin{aligned} \Delta_1 u &= \left(\frac{\partial u}{\partial R} \right)^2 + \frac{1}{R^2} \left(\frac{\partial u}{\partial \varphi} \right)^2 + \left(\frac{\partial u}{\partial z} \right)^2 \\ &= \left(\frac{\partial u}{\partial r} \right)^2 + \frac{1}{r^2} \left(\frac{\partial u}{\partial \theta} \right)^2 + \frac{1}{r^2 \sin^2 \theta} \left(\frac{\partial u}{\partial \varphi} \right)^2, \\ \Delta_2 u &= \frac{\partial^2 u}{\partial R^2} + \frac{1}{R^2} \frac{\partial^2 u}{\partial \varphi^2} + \frac{1}{R} \frac{\partial u}{\partial R} + \frac{\partial^2 u}{\partial z^2} \\ &= \frac{\partial^2 u}{\partial r^2} + \frac{1}{r^2} \frac{\partial^2 u}{\partial \theta^2} + \frac{1}{r} \frac{\partial u}{\partial r} + \frac{1}{r^2 \sin^2 \theta} \frac{\partial^2 u}{\partial \varphi^2} \\ &\quad + \frac{1}{r \sin \theta} \left(\sin \theta \frac{\partial u}{\partial r} + \frac{\cos \theta}{r} \frac{\partial u}{\partial \theta} \right) \\ &= \frac{\partial^2 u}{\partial r^2} + \frac{1}{r^2} \frac{\partial^2 u}{\partial \theta^2} + \frac{2}{r} \frac{\partial u}{\partial r} + \frac{1}{r^2 \sin^2 \theta} \frac{\partial^2 u}{\partial \varphi^2} \\ &\quad + \frac{1}{r^2 \operatorname{tg} \theta} \frac{\partial u}{\partial \theta} \\ &= \frac{1}{r^2} \left[\frac{\partial}{\partial r} \left(r^2 \frac{\partial u}{\partial r} \right) + \frac{1}{\sin \theta} \frac{\partial}{\partial \theta} \left(\sin \theta \frac{\partial u}{\partial \theta} \right) \right] \end{aligned}$$

$$\left. + \frac{1}{\sin^2 \theta} \frac{\partial^2 u}{\partial \varphi^2} \right\}.$$

注意到两次变换的乘积就是所给的变换，因此，最后得到的 $\Delta_1 u$ 及 $\Delta_2 u$ 的结果即为所求。

3512. 在方程

$$z \left(\frac{\partial^2 z}{\partial x^2} + \frac{\partial^2 z}{\partial y^2} \right) = \left(\frac{\partial z}{\partial x} \right)^2 + \left(\frac{\partial z}{\partial y} \right)^2$$

中引入新函数 w ，假定 $w = z^2$ 。

$$\text{解} \quad \frac{\partial z}{\partial x} = \frac{dz}{dw} \frac{\partial w}{\partial x} = \frac{1}{2z} \frac{\partial w}{\partial x}, \quad \frac{\partial z}{\partial y} = \frac{1}{2z} \frac{\partial w}{\partial y},$$

$$\begin{aligned} \frac{\partial^2 z}{\partial x^2} &= \frac{\partial}{\partial x} \left(\frac{\partial z}{\partial x} \right) = \frac{\partial}{\partial x} \left(\frac{1}{2z} \frac{\partial w}{\partial x} \right) \\ &= \frac{1}{2z} \frac{\partial^2 w}{\partial x^2} - \frac{1}{2z^2} \frac{\partial z}{\partial x} \frac{\partial w}{\partial x} \\ &= \frac{1}{2z} \frac{\partial^2 w}{\partial x^2} - \frac{1}{4z^3} \left(\frac{\partial w}{\partial x} \right)^2, \end{aligned}$$

$$\frac{\partial^2 z}{\partial y^2} = \frac{1}{2z} \frac{\partial^2 w}{\partial y^2} - \frac{1}{4z^3} \left(\frac{\partial w}{\partial y} \right)^2.$$

代入原方程，化简整理得

$$w \left(\frac{\partial^2 w}{\partial x^2} + \frac{\partial^2 w}{\partial y^2} \right) = \left(\frac{\partial w}{\partial x} \right)^2 + \left(\frac{\partial w}{\partial y} \right)^2,$$

即形式是不变的。

取 u 和 v 为新的自变量及 $w = w(u, v)$ 为新函数，变

换下列方程:

$$3513. \quad y \frac{\partial^2 z}{\partial y^2} + 2 \frac{\partial z}{\partial y} = \frac{z}{x}, \quad \text{设 } u = \frac{x}{y}, \quad v = x, \quad w = xz - y.$$

解 从 3513 题到 3522 题均属作变换

$$u = u(x, y), \quad v = v(x, y), \quad w = w(x, y, z)$$

的类型. 我们来导出一般公式, 顺便指出一般方法.

将 u, v 看作中间变量, x, y 看作自变量, 则有

$$du = \frac{\partial u}{\partial x} dx + \frac{\partial u}{\partial y} dy, \quad dv = \frac{\partial v}{\partial x} dx + \frac{\partial v}{\partial y} dy,$$

$$dw = \frac{\partial w}{\partial x} dx + \frac{\partial w}{\partial y} dy + \frac{\partial w}{\partial z} dz.$$

$$d^2u = \frac{\partial^2 u}{\partial x^2} dx^2 + 2 \frac{\partial^2 u}{\partial x \partial y} dx dy + \frac{\partial^2 u}{\partial y^2} dy^2,$$

$$d^2v = \frac{\partial^2 v}{\partial x^2} dx^2 + 2 \frac{\partial^2 v}{\partial x \partial y} dx dy + \frac{\partial^2 v}{\partial y^2} dy^2.$$

$$d^2w = \frac{\partial^2 w}{\partial x^2} dx^2 + \frac{\partial^2 w}{\partial y^2} dy^2 + \frac{\partial^2 w}{\partial z^2} dz^2$$

$$+ 2 \frac{\partial^2 w}{\partial x \partial y} dx dy + 2 \frac{\partial^2 w}{\partial y \partial z} dy dz$$

$$+ 2 \frac{\partial^2 w}{\partial z \partial x} dz dx + \frac{\partial w}{\partial z} d^2z.$$

将 dw, du 及 dv 代入全微分式

$$dw = \frac{\partial w}{\partial u} du + \frac{\partial w}{\partial v} dv,$$

化简整理得

$$\begin{aligned} \frac{\partial w}{\partial z} dz &= \left(\frac{\partial w}{\partial u} \frac{\partial u}{\partial x} + \frac{\partial w}{\partial v} \frac{\partial v}{\partial x} - \frac{\partial w}{\partial x} \right) dx \\ &+ \left(\frac{\partial w}{\partial u} \frac{\partial u}{\partial y} + \frac{\partial w}{\partial v} \frac{\partial v}{\partial y} - \frac{\partial w}{\partial y} \right) dy. \end{aligned}$$

于是,

$$\begin{cases} \frac{\partial z}{\partial x} = \left(\frac{\partial w}{\partial z} \right)^{-1} \left(\frac{\partial w}{\partial u} \frac{\partial u}{\partial x} + \frac{\partial w}{\partial v} \frac{\partial v}{\partial x} - \frac{\partial w}{\partial x} \right), \\ \frac{\partial z}{\partial y} = \left(\frac{\partial w}{\partial z} \right)^{-1} \left(\frac{\partial w}{\partial u} \frac{\partial u}{\partial y} + \frac{\partial w}{\partial v} \frac{\partial v}{\partial y} - \frac{\partial w}{\partial y} \right), \end{cases} \quad \text{公式12}$$

其中 $\frac{\partial z}{\partial x}$ 及 $\frac{\partial z}{\partial y}$ 是原方程中旧变元间的偏导函数, 而 $\frac{\partial w}{\partial u}$

及 $\frac{\partial w}{\partial v}$ 是变换后新变元间的偏导函数, 其它均为由已

给变换导出的已知关系式.

把上面求得的 d^2w , du , dv , d^2u , d^2v 代入表示新变元关系的二阶全微分式:

$$\begin{aligned} d^2w &= \frac{\partial^2 w}{\partial u^2} du^2 + 2 \frac{\partial^2 w}{\partial u \partial v} dudv + \frac{\partial^2 w}{\partial v^2} dv^2 \\ &+ \frac{\partial w}{\partial u} d^2u + \frac{\partial w}{\partial v} d^2v, \end{aligned}$$

再把式中的 dz 表成已求得的 $\frac{\partial z}{\partial x} dx + \frac{\partial z}{\partial y} dy$, 按

dx^2 , $dx dy$ 及 dy^2 合并同类项, 最后把所得的结果与表示旧变元关系的全微分式:

$$d^2z = \frac{\partial^2 z}{\partial x^2} dx^2 + 2 \frac{\partial^2 z}{\partial x \partial y} dx dy + \frac{\partial^2 z}{\partial y^2} dy^2$$

相比较，即得

$$\begin{aligned} \frac{\partial^2 z}{\partial x^2} &= \left(\frac{\partial w}{\partial z}\right)^{-1} \left[\frac{\partial^2 w}{\partial u^2} \left(\frac{\partial u}{\partial x}\right)^2 \right. \\ &+ 2 \frac{\partial^2 w}{\partial u \partial v} \frac{\partial u}{\partial x} \frac{\partial v}{\partial x} + \frac{\partial^2 w}{\partial v^2} \left(\frac{\partial v}{\partial x}\right)^2 \\ &+ \frac{\partial w}{\partial u} \frac{\partial^2 u}{\partial x^2} + \frac{\partial w}{\partial v} \frac{\partial^2 v}{\partial x^2} - \frac{\partial^2 w}{\partial x^2} \\ &\left. - \frac{\partial^2 w}{\partial z^2} \left(\frac{\partial z}{\partial x}\right)^2 - 2 \frac{\partial^2 w}{\partial x \partial z} \frac{\partial z}{\partial x} \right], \\ \frac{\partial^2 z}{\partial x \partial y} &= \left(\frac{\partial w}{\partial z}\right)^{-1} \left[\frac{\partial^2 w}{\partial u^2} \frac{\partial u}{\partial x} \frac{\partial u}{\partial y} \right. \\ &+ \frac{\partial^2 w}{\partial u \partial v} \left(\frac{\partial u}{\partial x} \frac{\partial v}{\partial y} + \frac{\partial u}{\partial y} \frac{\partial v}{\partial x}\right) \\ &+ \frac{\partial^2 w}{\partial v^2} \frac{\partial v}{\partial x} \frac{\partial v}{\partial y} + \frac{\partial w}{\partial u} \frac{\partial^2 u}{\partial x \partial y} \\ &+ \frac{\partial w}{\partial v} \frac{\partial^2 v}{\partial x \partial y} - \frac{\partial^2 w}{\partial x \partial y} \\ &\left. - \frac{\partial^2 w}{\partial z^2} \frac{\partial z}{\partial x} \frac{\partial z}{\partial y} - \frac{\partial^2 w}{\partial x \partial z} \frac{\partial z}{\partial y} - \frac{\partial^2 w}{\partial y \partial z} \frac{\partial z}{\partial x} \right], \\ \frac{\partial^2 z}{\partial y^2} &= \left(\frac{\partial w}{\partial z}\right)^{-1} \left[\frac{\partial^2 w}{\partial u^2} \left(\frac{\partial u}{\partial y}\right)^2 \right. \end{aligned}$$

$$\begin{aligned}
& + 2 \frac{\partial^2 w}{\partial u \partial v} \frac{\partial u}{\partial y} \frac{\partial v}{\partial y} + \frac{\partial^2 w}{\partial v^2} \left(\frac{\partial v}{\partial y} \right)^2 \\
& + \frac{\partial w}{\partial u} \frac{\partial^2 u}{\partial y^2} + \frac{\partial w}{\partial v} \frac{\partial^2 v}{\partial y^2} - \frac{\partial^2 w}{\partial y^2} \\
& - \frac{\partial^2 w}{\partial z^2} \left(\frac{\partial z}{\partial y} \right)^2 - 2 \frac{\partial^2 w}{\partial y \partial z} \frac{\partial z}{\partial y} \Big]. \quad \text{公式13}
\end{aligned}$$

公式13太复杂，一般不直接应用。本题用求偏导数法较方便。由于

$$\frac{\partial w}{\partial y} = x \frac{\partial z}{\partial y} - 1$$

$$\text{及 } \frac{\partial w}{\partial y} = \frac{\partial w}{\partial u} \frac{\partial u}{\partial y} + \frac{\partial w}{\partial v} \frac{\partial v}{\partial y} = -\frac{x}{y^2} \frac{\partial w}{\partial u},$$

故得

$$\frac{\partial z}{\partial y} = \frac{1}{x} - \frac{1}{y^2} \frac{\partial w}{\partial u}.$$

于是，

$$\begin{aligned}
y \frac{\partial^2 z}{\partial y^2} + 2 \frac{\partial z}{\partial y} &= \frac{1}{y} \left(y^2 \frac{\partial^2 z}{\partial y^2} + 2y \frac{\partial z}{\partial y} \right) \\
&= y^{-1} \frac{\partial}{\partial y} \left(y^2 \frac{\partial z}{\partial y} \right) \\
&= y^{-1} \frac{\partial}{\partial y} \left[y^2 \left(\frac{1}{x} - \frac{1}{y^2} \frac{\partial w}{\partial u} \right) \right]
\end{aligned}$$

$$\begin{aligned}
&= y^{-1} \frac{\partial}{\partial y} \left(\frac{y^2}{x} \right) - y^{-1} \frac{\partial}{\partial y} \left(\frac{\partial w}{\partial u} \right) \\
&= \frac{2}{x} - y^{-1} \left[\frac{\partial}{\partial u} \left(\frac{\partial w}{\partial u} \right) \frac{\partial u}{\partial y} + \frac{\partial}{\partial v} \left(\frac{\partial w}{\partial u} \right) \frac{\partial v}{\partial y} \right] \\
&= \frac{2}{x} + \frac{x}{y^3} \frac{\partial^2 w}{\partial u^2} = \frac{2}{x}.
\end{aligned}$$

由于 $\frac{x}{y^3} \neq 0$ ，故原方程变换为

$$\frac{\partial^2 w}{\partial u^2} = 0.$$

3514. $\frac{\partial^2 z}{\partial x^2} - 2 \frac{\partial^2 z}{\partial x \partial y} + \frac{\partial^2 z}{\partial y^2} = 0$ ，设 $u = x + y$ ， $v = \frac{y}{x}$ ，

$$w = \frac{z}{x}.$$

解 $\frac{\partial u}{\partial x} = \frac{\partial u}{\partial y} = 1$ ， $\frac{\partial v}{\partial x} = -\frac{y}{x^2}$ ， $\frac{\partial v}{\partial y} = \frac{1}{x}$ ，

$$\frac{\partial w}{\partial x} = -\frac{z}{x^2}$$
， $\frac{\partial w}{\partial y} = 0$ ， $\frac{\partial w}{\partial z} = \frac{1}{x}$.

代入公式12，得

$$\begin{aligned}
\frac{\partial z}{\partial x} &= x \left(\frac{\partial w}{\partial u} - \frac{y}{x^2} \frac{\partial w}{\partial v} + \frac{z}{x^2} \right) \\
&= x \frac{\partial w}{\partial u} - \frac{y}{x} \frac{\partial w}{\partial v} + \frac{z}{x},
\end{aligned}$$

$$\frac{\partial z}{\partial y} = x \left(\frac{\partial w}{\partial u} + \frac{1}{x} \frac{\partial w}{\partial v} \right) = x \frac{\partial w}{\partial u} + \frac{\partial w}{\partial v}.$$

$$\text{令 } R = \frac{\partial z}{\partial x} - \frac{\partial z}{\partial y} = -\frac{y}{x} \frac{\partial w}{\partial v} + \frac{z}{x} - \frac{\partial w}{\partial v} = w - (1+v)$$

$\cdot \frac{\partial w}{\partial v}$. 于是,

$$\begin{aligned} & \frac{\partial^2 z}{\partial x^2} - 2 \frac{\partial^2 z}{\partial x \partial y} + \frac{\partial^2 z}{\partial y^2} = \left(\frac{\partial^2 z}{\partial x^2} - \frac{\partial^2 z}{\partial x \partial y} \right) \\ & \quad - \left(\frac{\partial^2 z}{\partial x \partial y} - \frac{\partial^2 z}{\partial y^2} \right) \\ & = \frac{\partial}{\partial x} \left(\frac{\partial z}{\partial x} - \frac{\partial z}{\partial y} \right) - \frac{\partial}{\partial y} \left(\frac{\partial z}{\partial x} - \frac{\partial z}{\partial y} \right) = \frac{\partial R}{\partial x} - \frac{\partial R}{\partial y} \\ & = \frac{\partial R}{\partial u} \frac{\partial u}{\partial x} + \frac{\partial R}{\partial v} \frac{\partial v}{\partial x} - \frac{\partial R}{\partial u} \frac{\partial u}{\partial y} - \frac{\partial R}{\partial v} \frac{\partial v}{\partial y} \\ & = \frac{\partial R}{\partial u} \left(\frac{\partial u}{\partial x} - \frac{\partial u}{\partial y} \right) + \frac{\partial R}{\partial v} \left(\frac{\partial v}{\partial x} - \frac{\partial v}{\partial y} \right) \\ & = \frac{\partial}{\partial v} \left[w - (1+v) \frac{\partial w}{\partial v} \right] \left(-\frac{y}{x^2} - \frac{1}{x} \right) \\ & = \left[\frac{\partial w}{\partial v} - \frac{\partial w}{\partial v} - (1+v) \frac{\partial^2 w}{\partial v^2} \right] \left[-\frac{1}{x} (1+v) \right] \\ & = \frac{1}{x} (1+v)^2 \frac{\partial^2 w}{\partial v^2} = 0, \end{aligned}$$

由于 $x \neq 0$, $1 + v \neq 0$, 故原方程变为

$$\frac{\partial^2 w}{\partial v^2} = 0.$$

3515. $\frac{\partial^2 z}{\partial x^2} + 2 \frac{\partial^2 z}{\partial x \partial y} + \frac{\partial^2 z}{\partial y^2} = 0$, 设 $u = x + y, v = x - y$,

$$w = xy - z.$$

解 $\frac{\partial u}{\partial x} = \frac{\partial u}{\partial y} = \frac{\partial v}{\partial x} = 1, \frac{\partial v}{\partial y} = -1,$

$$\frac{\partial w}{\partial x} = y, \frac{\partial w}{\partial y} = x, \frac{\partial w}{\partial z} = -1.$$

代入公式12, 得

$$\frac{\partial z}{\partial x} = y - \frac{\partial w}{\partial u} - \frac{\partial w}{\partial v}, \frac{\partial z}{\partial y} = x - \frac{\partial w}{\partial u} + \frac{\partial w}{\partial v}.$$

令 $R = \frac{\partial z}{\partial x} + \frac{\partial z}{\partial y} = x + y - 2 \frac{\partial w}{\partial u} = u - 2 \frac{\partial w}{\partial u}$. 于是,

$$\frac{\partial^2 z}{\partial x^2} + 2 \frac{\partial^2 z}{\partial x \partial y} + \frac{\partial^2 z}{\partial y^2} = \frac{\partial}{\partial x} \left(\frac{\partial z}{\partial x} + \frac{\partial z}{\partial y} \right)$$

$$+ \frac{\partial}{\partial y} \left(\frac{\partial z}{\partial x} + \frac{\partial z}{\partial y} \right)$$

$$= \frac{\partial R}{\partial x} + \frac{\partial R}{\partial y} = \frac{\partial R}{\partial u} \left(\frac{\partial u}{\partial x} + \frac{\partial u}{\partial y} \right) + \frac{\partial R}{\partial v} \left(\frac{\partial v}{\partial x} + \frac{\partial v}{\partial y} \right)$$

$$= 2 \frac{\partial}{\partial u} \left(u - 2 \frac{\partial w}{\partial u} \right) = 2 - 4 \frac{\partial^2 w}{\partial u^2} = 0,$$

原方程变换为

$$\frac{\partial^2 w}{\partial u^2} = \frac{1}{2}.$$

3516. $\frac{\partial^2 z}{\partial x^2} + \frac{\partial^2 z}{\partial x \partial y} + \frac{\partial z}{\partial x} = z$, 设 $u = \frac{x+y}{2}$, $v = \frac{x-y}{2}$,

$$w = ze^v.$$

解 $\frac{\partial u}{\partial x} = \frac{\partial u}{\partial y} = \frac{\partial v}{\partial x} = \frac{1}{2} = -\frac{\partial v}{\partial y}$,

$$\frac{\partial w}{\partial x} = 0, \quad \frac{\partial w}{\partial y} = ze^v, \quad \frac{\partial w}{\partial z} = e^v.$$

代入公式12, 得

$$\frac{\partial z}{\partial x} = \frac{1}{2} e^{-v} \left(\frac{\partial w}{\partial u} + \frac{\partial w}{\partial v} \right),$$

$$\frac{\partial z}{\partial y} = \frac{1}{2} e^{-v} \left(\frac{\partial w}{\partial u} - \frac{\partial w}{\partial v} \right) - z.$$

于是,

$$\frac{\partial^2 z}{\partial x^2} + \frac{\partial^2 z}{\partial x \partial y} + \frac{\partial z}{\partial x} = \frac{\partial}{\partial x} \left(\frac{\partial z}{\partial x} + \frac{\partial z}{\partial y} + z \right)$$

$$= \frac{\partial}{\partial x} \left(e^{-v} \frac{\partial w}{\partial u} \right)$$

$$= e^{-v} \frac{\partial}{\partial x} \left(\frac{\partial w}{\partial u} \right) = e^{-v} \left(\frac{\partial^2 w}{\partial u^2} \frac{\partial u}{\partial x} + \frac{\partial^2 w}{\partial u \partial v} \frac{\partial v}{\partial x} \right)$$

$$= \frac{1}{2} e^{-z} \left(\frac{\partial^2 w}{\partial u^2} + \frac{\partial^2 w}{\partial u \partial v} \right) = z.$$

原方程变换为

$$\frac{\partial^2 w}{\partial u^2} + \frac{\partial^2 w}{\partial u \partial v} = 2z e^z = 2w.$$

3517. $\frac{\partial^2 z}{\partial x^2} - 2 \frac{\partial^2 z}{\partial x \partial y} + \left(1 + \frac{y}{x}\right) \frac{\partial^2 z}{\partial y^2} = 0$, 设 $u = x$, $v = x$

$+ y$, $w = x + y + z$.

解 由公式12不难求出

$$\frac{\partial z}{\partial x} = \frac{\partial w}{\partial u} + \frac{\partial w}{\partial v} - 1, \quad \frac{\partial z}{\partial y} = \frac{\partial w}{\partial v} - 1.$$

于是,

$$\frac{\partial z}{\partial x} - \frac{\partial z}{\partial y} = \frac{\partial w}{\partial u}.$$

同 3514 题的方法可求得

$$\begin{aligned} \frac{\partial^2 u}{\partial x^2} - 2 \frac{\partial^2 z}{\partial x \partial y} + \frac{\partial^2 z}{\partial y^2} &= \left(\frac{\partial}{\partial x} - \frac{\partial}{\partial y} \right) \left(\frac{\partial z}{\partial x} - \frac{\partial z}{\partial y} \right) \\ &= \frac{\partial}{\partial u} \left(\frac{\partial w}{\partial u} \right) \left(\frac{\partial u}{\partial x} - \frac{\partial u}{\partial y} \right) + \frac{\partial}{\partial v} \left(\frac{\partial w}{\partial u} \right) \\ &\quad \cdot \left(\frac{\partial v}{\partial x} - \frac{\partial v}{\partial y} \right) = \frac{\partial^2 w}{\partial u^2}, \end{aligned}$$

$$\frac{y}{x} \frac{\partial^2 z}{\partial y^2} = \left(\frac{v}{u} - 1 \right) \frac{\partial}{\partial y} \left(\frac{\partial w}{\partial v} - 1 \right)$$

$$\begin{aligned}
&= \left(\frac{v}{u} - 1\right) \left[\frac{\partial}{\partial u} \left(\frac{\partial w}{\partial v} \right) \frac{\partial u}{\partial y} + \frac{\partial}{\partial v} \left(\frac{\partial w}{\partial v} \right) \frac{\partial v}{\partial y} \right] \\
&= \left(\frac{v}{u} - 1\right) \frac{\partial^2 w}{\partial v^2}.
\end{aligned}$$

將上述結果代入原方程，即得

$$\frac{\partial^2 w}{\partial u^2} + \left(\frac{v}{u} - 1\right) \frac{\partial^2 w}{\partial v^2} = 0.$$

3518. $(1-x^2) \frac{\partial^2 z}{\partial x^2} + (1-y^2) \frac{\partial^2 z}{\partial y^2} = x \frac{\partial z}{\partial x} + y \frac{\partial z}{\partial y}$ ，設

$$x = \sin u, \quad y = \sin v, \quad z = e^w.$$

解 $\frac{\partial z}{\partial x} = \frac{dz}{dw} \frac{\partial w}{\partial u} \frac{du}{dx} = \frac{e^w}{\cos u} \frac{\partial w}{\partial u}$ ，

$$\frac{\partial z}{\partial y} = \frac{e^w}{\cos v} \frac{\partial w}{\partial v}，$$

$$\begin{aligned}
\frac{\partial^2 z}{\partial x^2} &= \frac{\partial}{\partial x} \left(\frac{e^w}{\cos u} \frac{\partial w}{\partial u} \right) = \frac{\partial}{\partial u} \left(\frac{e^w}{\cos u} \frac{\partial w}{\partial u} \right) \cdot \frac{du}{dx} \\
&= \frac{1}{\cos u} \left[\frac{e^w}{\cos u} \left(\frac{\partial w}{\partial u} \right)^2 + \frac{e^w}{\cos u} \frac{\partial^2 w}{\partial u^2} + \frac{e^w \sin u}{\cos^2 u} \frac{\partial w}{\partial u} \right] \\
&= \frac{e^w}{\cos^2 u} \left[\left(\frac{\partial w}{\partial u} \right)^2 + \frac{\partial^2 w}{\partial u^2} + \operatorname{tg} u \cdot \frac{\partial w}{\partial u} \right],
\end{aligned}$$

$$\frac{\partial^2 z}{\partial y^2} = \frac{e^w}{\cos^2 v} \left[\left(\frac{\partial w}{\partial v} \right)^2 + \frac{\partial^2 w}{\partial v^2} + \operatorname{tg} v \cdot \frac{\partial w}{\partial v} \right].$$

將上述結果代入原方程，並注意到

$$1 - x^2 = \cos^2 u, \quad 1 - y^2 = \cos^2 v,$$

化简整理即得

$$\frac{\partial^2 w}{\partial u^2} + \frac{\partial^2 w}{\partial v^2} + \left(\frac{\partial w}{\partial u}\right)^2 + \left(\frac{\partial w}{\partial v}\right)^2 = 0.$$

3519. $(1-x^2) \frac{\partial^2 z}{\partial x^2} - \frac{\partial^2 z}{\partial y^2} - 2x \frac{\partial z}{\partial x} - \frac{1}{4}z = 0$ ($|x| < 1$), 设

$$u = \frac{1}{2}(y + \arccos x), \quad v = \frac{1}{2}(y - \arccos x), \quad w =$$

$$z\sqrt{1-x^2}.$$

解 由公式12不难求出

$$\frac{\partial z}{\partial x} = \frac{1}{2(1-x^2)^{\frac{3}{4}}} \left(\frac{\partial w}{\partial v} - \frac{\partial w}{\partial u} \right) + \frac{xz}{2(1-x^2)},$$

$$\frac{\partial z}{\partial y} = \frac{1}{2(1-x^2)^{\frac{1}{4}}} \left(\frac{\partial w}{\partial u} + \frac{\partial w}{\partial v} \right).$$

于是,

$$\begin{aligned} (1-x^2) \frac{\partial^2 z}{\partial x^2} - 2x \frac{\partial z}{\partial x} &= \frac{\partial}{\partial x} \left[(1-x^2) \frac{\partial z}{\partial x} \right] \\ &= \frac{\partial}{\partial x} \left[\frac{(1-x^2)^{\frac{1}{4}}}{2} \left(\frac{\partial w}{\partial v} - \frac{\partial w}{\partial u} \right) + \frac{xz}{2} \right] \\ &= -\frac{x}{4(1-x^2)^{\frac{3}{4}}} \left(\frac{\partial w}{\partial v} - \frac{\partial w}{\partial u} \right) + \frac{z}{2} + \frac{x}{2} \frac{\partial z}{\partial x} \\ &\quad + \frac{(1-x^2)^{\frac{1}{4}}}{2} \frac{\partial}{\partial x} \left(\frac{\partial w}{\partial v} - \frac{\partial w}{\partial u} \right) \end{aligned}$$

$$\begin{aligned}
&= \frac{z}{2} + \frac{x^2 z}{4(1-x^2)} + \frac{(1-x^2)^{\frac{1}{4}}}{2} \left[\frac{\partial}{\partial u} \left(\frac{\partial w}{\partial v} \right. \right. \\
&\quad \left. \left. - \frac{\partial w}{\partial u} \right) \frac{\partial u}{\partial x} + \frac{\partial}{\partial v} \left(\frac{\partial w}{\partial v} - \frac{\partial w}{\partial u} \right) \frac{\partial v}{\partial x} \right] \\
&= \frac{z}{4} + \frac{z}{4(1-x^2)} + \frac{1}{4(1-x^2)^{\frac{1}{4}}} \\
&\quad \cdot \left(\frac{\partial^2 w}{\partial u^2} - 2 \frac{\partial^2 w}{\partial u \partial v} + \frac{\partial^2 w}{\partial v^2} \right), \\
\frac{\partial^2 z}{\partial y^2} &= \frac{\partial}{\partial y} \left(\frac{\partial z}{\partial y} \right) = \frac{1}{2(1-x^2)^{\frac{1}{4}}} \left[\frac{\partial}{\partial u} \left(\frac{\partial w}{\partial u} + \frac{\partial w}{\partial v} \right) \right. \\
&\quad \left. \cdot \frac{\partial u}{\partial y} + \frac{\partial}{\partial v} \left(\frac{\partial w}{\partial u} + \frac{\partial w}{\partial v} \right) \frac{\partial v}{\partial y} \right] \\
&= \frac{1}{4(1-x^2)^{\frac{1}{4}}} \left(\frac{\partial^2 w}{\partial u^2} + 2 \frac{\partial^2 w}{\partial u \partial v} + \frac{\partial^2 w}{\partial v^2} \right).
\end{aligned}$$

将上述结果代入原方程，并注意

$$\arccos x = u - v, \quad x = \cos(u - v),$$

$$1 - x^2 = \sin^2(u - v),$$

化简整理即得

$$\frac{\partial^2 w}{\partial u \partial v} = \frac{w}{4 \sin^2(u - v)}.$$

$$3520. \quad \frac{\partial^2 z}{\partial x^2} + \frac{\partial^2 z}{\partial y^2} = 2 \frac{x \frac{\partial z}{\partial x} - y \frac{\partial z}{\partial y}}{x^2 - y^2} - \frac{3(x^2 + y^2)z}{(x^2 - y^2)^2} \quad (|x|$$

$\geq |y|$), 设 $u = x + y, v = x - y, w = \frac{z}{\sqrt{x^2 - y^2}}$.

解 原方程可改写为

$$\frac{1}{x^2 - y^2} \frac{\partial^2 z}{\partial x^2} + \frac{1}{x^2 - y^2} \frac{\partial^2 z}{\partial y^2} - \frac{2x}{(x^2 - y^2)^2} \cdot \frac{\partial z}{\partial x} + \frac{2y}{(x^2 - y^2)^2} \frac{\partial z}{\partial y} = - \frac{3(x^2 + y^2)z}{(x^2 - y^2)^3}$$

或

$$\begin{aligned} & \frac{\partial}{\partial x} \left(\frac{1}{x^2 - y^2} \frac{\partial z}{\partial x} \right) + \frac{\partial}{\partial y} \left(\frac{1}{x^2 - y^2} \frac{\partial z}{\partial y} \right) \\ &= - \frac{3(x^2 + y^2)z}{(x^2 - y^2)^3}. \end{aligned} \quad (1)$$

由公式12不难求出

$$\frac{\partial z}{\partial x} = \sqrt{x^2 - y^2} \left(\frac{\partial w}{\partial u} + \frac{\partial w}{\partial v} \right) + \frac{xz}{x^2 - y^2},$$

$$\frac{\partial z}{\partial y} = \sqrt{x^2 - y^2} \left(\frac{\partial w}{\partial u} - \frac{\partial w}{\partial v} \right) - \frac{yz}{x^2 - y^2}.$$

于是,

$$\begin{aligned} & \frac{\partial}{\partial x} \left(\frac{1}{x^2 - y^2} \frac{\partial z}{\partial x} \right) = \frac{\partial}{\partial x} \left[\frac{1}{\sqrt{x^2 - y^2}} \right. \\ & \quad \left. \cdot \left(\frac{\partial w}{\partial u} + \frac{\partial w}{\partial v} \right) + \frac{xz}{(x^2 - y^2)^2} \right] \\ &= - \frac{x}{(x^2 - y^2)^{\frac{3}{2}}} \left(\frac{\partial w}{\partial u} + \frac{\partial w}{\partial v} \right) + \frac{x}{(x^2 - y^2)^2} \frac{\partial z}{\partial x} \end{aligned}$$

$$\begin{aligned}
& + \frac{z}{(x^2 - y^2)^2} - \frac{4x^2 z}{(x^2 - y^2)^3} \\
& + \frac{1}{\sqrt{x^2 - y^2}} \frac{\partial}{\partial x} \left(\frac{\partial w}{\partial u} + \frac{\partial w}{\partial v} \right) \\
= & \frac{z}{(x^2 - y^2)^2} - \frac{3x^2 z}{(x^2 - y^2)^3} + \frac{1}{\sqrt{x^2 - y^2}} \\
& \cdot \left[\frac{\partial}{\partial u} \left(\frac{\partial w}{\partial u} + \frac{\partial w}{\partial v} \right) \frac{\partial u}{\partial x} + \frac{\partial}{\partial v} \left(\frac{\partial w}{\partial u} + \frac{\partial w}{\partial v} \right) \frac{\partial v}{\partial x} \right] \\
= & \frac{z}{(x^2 - y^2)^2} - \frac{3x^2 z}{(x^2 - y^2)^3} \\
& + \frac{1}{\sqrt{x^2 - y^2}} \left(\frac{\partial^2 w}{\partial u^2} + 2 \frac{\partial^2 w}{\partial u \partial v} + \frac{\partial^2 w}{\partial v^2} \right).
\end{aligned}$$

同法可求得

$$\begin{aligned}
& \frac{\partial}{\partial y} \left(\frac{1}{x^2 - y^2} \frac{\partial z}{\partial y} \right) = \frac{\partial}{\partial y} \left[\frac{1}{\sqrt{x^2 - y^2}} \right. \\
& \left. \cdot \left(\frac{\partial w}{\partial u} - \frac{\partial w}{\partial v} \right) - \frac{yz}{(x^2 - y^2)^2} \right] \\
= & -\frac{z}{(x^2 - y^2)^2} - \frac{3y^2 z}{(x^2 - y^2)^3} \\
& + \frac{1}{\sqrt{x^2 - y^2}} \left(\frac{\partial^2 w}{\partial u^2} - 2 \frac{\partial^2 w}{\partial u \partial v} + \frac{\partial^2 w}{\partial v^2} \right).
\end{aligned}$$

把上述结果代入方程(1)，化简整理即得

$$\frac{\partial^2 w}{\partial u^2} + \frac{\partial^2 w}{\partial v^2} = 0.$$

3521. 证明: 任何方程

$$\frac{\partial^2 z}{\partial x \partial y} + a \frac{\partial z}{\partial x} + b \frac{\partial z}{\partial y} + cz = 0$$

(a, b, c 为常数) 用代换

$$z = ue^{\alpha x + \beta y}$$

(其中 α 与 β 为常量, $u = u(x, y)$) 可以化为下面的形状

$$\frac{\partial^2 u}{\partial x \partial y} + c_1 u = 0 \quad (c_1 = \text{常数}).$$

证 $\frac{\partial z}{\partial x} = e^{\alpha x + \beta y} \left(\alpha u + \frac{\partial u}{\partial x} \right), \quad \frac{\partial z}{\partial y} = e^{\alpha x + \beta y} \left(\beta u + \frac{\partial u}{\partial y} \right),$

$$\frac{\partial^2 z}{\partial x \partial y} = e^{\alpha x + \beta y} \left(\alpha \beta u + \beta \frac{\partial u}{\partial x} + \alpha \frac{\partial u}{\partial y} + \frac{\partial^2 u}{\partial x \partial y} \right).$$

将上述结果代入所给方程, 得

$$\begin{aligned} & \frac{\partial^2 u}{\partial x \partial y} + (\beta + a) \frac{\partial u}{\partial x} + (\alpha + b) \frac{\partial u}{\partial y} + (\alpha \beta + a\alpha \\ & + b\beta + c) u = 0. \end{aligned}$$

按题意, 需 $\beta + a = 0$ 及 $\alpha + b = 0$, 即 $\beta = -a, \alpha = -b$, 这是可能的. 事实上, 只需取代换

$$z = ue^{-(bx + ay)},$$

原方程即变换为

$$\frac{\partial^2 u}{\partial x \partial y} + c_1 u = 0 \quad (c_1 \text{ 为常数}).$$

3522. 证明: 方程

$$\frac{\partial^2 u}{\partial x^2} = \frac{\partial u}{\partial y}$$

对于变量代换

$$x' = \frac{x}{y}, \quad y' = -\frac{1}{y}, \quad u = \frac{u'}{\sqrt{y}} e^{-\frac{x^2}{4y}}$$

(u' 为变量 x' 与 y' 的函数) 其形状不变.

证 $dx' = \frac{dx}{y} - \frac{x}{y^2} dy, \quad dy' = \frac{1}{y^2} dy,$

$$\ln u' = \ln u + \frac{1}{2} \ln y + \frac{x^2}{4y},$$

$$du' = \frac{u'}{u} du + \frac{u'}{2y} dy + \frac{xu'}{2y} dx - \frac{x^2 u'}{4y^2} dy.$$

把上面三个微分式代入

$$du' = \frac{\partial u'}{\partial x'} dx' + \frac{\partial u'}{\partial y'} dy'$$

得

$$\frac{u'}{u} du + \frac{u'}{2y} dy + \frac{xu'}{2y} dx - \frac{x^2 u'}{4y^2} dy$$

$$= \frac{\partial u'}{\partial x'} \left(\frac{1}{y} dx - \frac{x}{y^2} dy \right) + \frac{\partial u'}{\partial y'} \frac{dy}{y^2},$$

整理得

$$du = \left(\frac{u}{yu'} \frac{\partial u'}{\partial x'} - \frac{xu}{2y} \right) dx + \left(\frac{u}{y^2 u'} \frac{\partial u'}{\partial y'} \right) dy$$

$$-\frac{xu}{y^2u'} \frac{\partial u'}{\partial x'} + \frac{x^2u}{4y^2} - \frac{u}{2y} \Big) dy.$$

于是,

$$\frac{\partial u}{\partial x} = \frac{u}{yu'} \frac{\partial u'}{\partial x'} - \frac{xu}{2y},$$

$$\begin{aligned} \frac{\partial u}{\partial y} &= \frac{u}{y^2u'} \frac{\partial u'}{\partial y'} - \frac{xu}{y^2u'} \frac{\partial u'}{\partial x'} \\ &\quad + \frac{x^2u}{4y^2} - \frac{u}{2y}, \end{aligned} \tag{1}$$

$$\begin{aligned} \frac{\partial^2 u}{\partial x^2} &= \frac{\partial}{\partial x} \left(\frac{u}{yu'} \frac{\partial u'}{\partial x'} - \frac{xu}{2y} \right) \\ &= \frac{u}{yu'} \frac{\partial^2 u'}{\partial x'^2} \frac{\partial x'}{\partial x} + \frac{1}{yu'} \frac{\partial u'}{\partial x'} \frac{\partial u}{\partial x} - \frac{u}{yu'^2} \\ &\quad \cdot \left(\frac{\partial u'}{\partial x'} \right)^2 \frac{\partial x'}{\partial x} - \frac{u}{2y} - \frac{x}{2y} \frac{\partial u}{\partial x} \\ &= \frac{u}{y^2u'} \frac{\partial^2 u'}{\partial x'^2} + \left(\frac{1}{yu'} \frac{\partial u'}{\partial x'} - \frac{x}{2y} \right) \\ &\quad \cdot \left(\frac{u}{yu'} \frac{\partial u'}{\partial x'} - \frac{xu}{2y} \right) - \frac{u}{y^2u'^2} \left(\frac{\partial u'}{\partial x'} \right)^2 - \frac{u}{2y} \\ &= \frac{u}{y^2u'} \frac{\partial^2 u'}{\partial x'^2} - \frac{xu}{y^2u'} \frac{\partial u'}{\partial x'} \\ &\quad + \frac{x^2u}{4y^2} - \frac{u}{2y}. \end{aligned} \tag{2}$$

将(1)式和(2)式代入原方程, 得

$$\frac{\partial^2 u'}{\partial x'^2} = \frac{\partial u'}{\partial y'},$$

即方程的形式不变.

3523. 在方程

$$q(1+q)\frac{\partial^2 z}{\partial x^2} - (1+p+q+2pq)\frac{\partial^2 z}{\partial x\partial y} + p(1+p)\frac{\partial^2 z}{\partial y^2} = 0$$

(其中 $p = \frac{\partial z}{\partial x}$, $q = \frac{\partial z}{\partial y}$) 中令 $u = x + z$, $v = y + z$,

$w = x + y + z$, 假定 $w = w(u, v)$.

解 本题用全微分法解较好. 由

$$dz = p dx + q dy \text{ 及 } u = x + z, v = y + z, w = x + y + z$$

可得

$$du = dx + dz = (1+p)dx + qdy,$$

$$dv = dy + dz = p dx + (1+q)dy,$$

$$d^2u = d^2v = d^2w = d^2z.$$

把上述结果代入新变元的全微分式

$$d^2w = \frac{\partial^2 w}{\partial u^2} du^2 + 2 \frac{\partial^2 w}{\partial u \partial v} dudv + \frac{\partial^2 w}{\partial v^2} dv^2$$

$$+ \frac{\partial w}{\partial u} d^2u + \frac{\partial w}{\partial v} d^2v,$$

并记 $S = 1 - \frac{\partial w}{\partial u} - \frac{\partial w}{\partial v}$, 即得

$$Sd^2z = \frac{\partial^2 w}{\partial u^2} \left[(p+1)dx + qdy \right]^2 + 2 \frac{\partial^2 w}{\partial u \partial v} \cdot \left[(p+1)dx + qdy \right] \left[pdx + (q+1)dy \right] + \frac{\partial^2 w}{\partial v^2} \left[pdx + (q+1)dy \right]^2.$$

将上式与

$$d^2z = \frac{\partial^2 z}{\partial x^2} dx^2 + 2 \frac{\partial^2 z}{\partial x \partial y} dx dy + \frac{\partial^2 z}{\partial y^2} dy^2$$

比较, 可得

$$\frac{\partial^2 z}{\partial x^2} = \frac{1}{S} \left[(1+p)^2 \frac{\partial^2 w}{\partial u^2} + 2p(1+p) \right.$$

$$\left. \cdot \frac{\partial^2 w}{\partial u \partial v} + p^2 \frac{\partial^2 w}{\partial v^2} \right],$$

$$\frac{\partial^2 z}{\partial x \partial y} = \frac{1}{S} \left[q(p+1) \frac{\partial^2 w}{\partial u^2} + (1+p+q+2pq) \right.$$

$$\left. \cdot \frac{\partial^2 w}{\partial u \partial v} + p(q+1) \frac{\partial^2 w}{\partial v^2} \right],$$

$$\frac{\partial^2 z}{\partial y^2} = \frac{1}{S} \left[q^2 \frac{\partial^2 w}{\partial u^2} + 2q(q+1) \frac{\partial^2 w}{\partial u \partial v} \right.$$

$$\left. + (q+1)^2 \frac{\partial^2 w}{\partial v^2} \right].$$

代入原方程, 并注意到

$$\begin{aligned} & q(1+q)(1+p)^2 - (1+p+q+2pq)q \\ & \cdot (p+1) + p(1+p)q^2 \\ & = q(1+p) \left[(1+p)(1+q) - (1+p \right. \end{aligned}$$

$$+q+2pq)+pq]=0,$$

$$p^2q(1+q)-(1+p+q+2pq)p(q+1) \\ +p(1+p)(q+1)^2=0$$

及

$$2p(1+p)q(1+q)-(1+p+q+2pq)^2 \\ +2q(q+1)p(1+p)=-(1+p+q)^2,$$

原方程变换为

$$-\frac{(1+p+q)^2}{S} \frac{\partial^2 w}{\partial u \partial v} = 0 \text{ 或 } \frac{\partial^2 w}{\partial u \partial v} = 0.$$

3524. 在方程

$$x^2 \frac{\partial^2 u}{\partial x^2} + y^2 \frac{\partial^2 u}{\partial y^2} + z^2 \frac{\partial^2 u}{\partial z^2} = \left(x \frac{\partial u}{\partial x}\right)^2 \\ + \left(y \frac{\partial u}{\partial y}\right)^2 + \left(z \frac{\partial u}{\partial z}\right)^2$$

中令 $x=e^\xi, y=e^\eta, z=e^\xi, u=e^w$, 其中 $w=w(\xi, \eta, \xi)$.

$$\text{解 } \frac{\partial u}{\partial x} = \frac{du}{dw} \cdot \frac{\partial w}{\partial \xi} \frac{d\xi}{dx} = \frac{e^w}{x} \frac{\partial w}{\partial \xi},$$

$$x \frac{\partial u}{\partial x} = e^w \frac{\partial w}{\partial \xi}, \quad (1)$$

$$y \frac{\partial u}{\partial y} = e^w \frac{\partial w}{\partial \eta}, \quad z \frac{\partial u}{\partial z} = e^w \frac{\partial w}{\partial \xi}.$$

(1)式两端对 x 求偏导函数, 得

$$x \frac{\partial^2 u}{\partial x^2} + \frac{\partial u}{\partial x} = e^w \left(\frac{\partial w}{\partial \xi}\right)^2 \frac{d\xi}{dx} + e^w \frac{\partial^2 w}{\partial \xi^2} \frac{d\xi}{dx}.$$

两端同乘 x , 整理得

$$x^2 \frac{\partial^2 u}{\partial x^2} = e^w \left(\frac{\partial w}{\partial \xi} \right)^2 + e^w \frac{\partial^2 w}{\partial \xi^2} - e^w \frac{\partial w}{\partial \xi}. \quad (2)$$

同法可得

$$y^2 \frac{\partial^2 u}{\partial y^2} = e^w \left(\frac{\partial w}{\partial \eta} \right)^2 + e^w \frac{\partial^2 w}{\partial \eta^2} - e^w \frac{\partial w}{\partial \eta}, \quad (3)$$

$$z^2 \frac{\partial^2 u}{\partial z^2} = e^w \left(\frac{\partial w}{\partial \zeta} \right)^2 + e^w \frac{\partial^2 w}{\partial \zeta^2} - e^w \frac{\partial w}{\partial \zeta}. \quad (4)$$

将(2), (3), (4)三式代入原方程, 化简整理即得

$$\begin{aligned} \frac{\partial^2 w}{\partial \xi^2} + \frac{\partial^2 w}{\partial \eta^2} + \frac{\partial^2 w}{\partial \zeta^2} &= (e^w - 1) \left[\left(\frac{\partial w}{\partial \xi} \right)^2 \right. \\ &\left. + \left(\frac{\partial w}{\partial \eta} \right)^2 + \left(\frac{\partial w}{\partial \zeta} \right)^2 \right] + \frac{\partial w}{\partial \xi} + \frac{\partial w}{\partial \eta} + \frac{\partial w}{\partial \zeta}. \end{aligned}$$

3525. 证明: 方程

$$\frac{\partial^2 z}{\partial x^2} \frac{\partial^2 z}{\partial y^2} - \left(\frac{\partial^2 z}{\partial x \partial y} \right)^2 = 0$$

的形状与变量 x , y 和 z 所分别担任的角色无关.

证 令 $p = \frac{\partial z}{\partial x}$, $q = \frac{\partial z}{\partial y}$, 则 $dz = p dx + q dy$. 若以 x

作为新函数, 则有

$$\begin{aligned} d^2 x &= \frac{\partial^2 x}{\partial y^2} dy^2 + 2 \frac{\partial^2 x}{\partial y \partial z} dy dz + \frac{\partial^2 x}{\partial z^2} dz^2 \\ &+ \frac{\partial x}{\partial y} d^2 y + \frac{\partial x}{\partial z} d^2 z. \end{aligned}$$

今以作为旧变元的关系:

$$d^2x = 0, \quad d^2y = 0, \quad dz = pdx + qdy$$

代入上式, 可得

$$d^2z = -\frac{1}{\frac{\partial x}{\partial z}} \left[\frac{\partial^2 x}{\partial y^2} dy^2 + 2 \frac{\partial^2 x}{\partial y \partial z} dy \cdot (pdx + qdy) + \frac{\partial^2 x}{\partial z^2} (pdx + qdy)^2 \right].$$

于是,

$$\frac{\partial^2 z}{\partial x^2} = -p \left(p^2 \frac{\partial^2 x}{\partial z^2} \right), \quad (1)$$

$$\frac{\partial^2 z}{\partial x \partial y} = -p \left(p \frac{\partial^2 x}{\partial y \partial z} + pq \frac{\partial^2 x}{\partial z^2} \right), \quad (2)$$

$$\frac{\partial^2 z}{\partial y^2} = -p \left(\frac{\partial^2 x}{\partial y^2} + 2q \frac{\partial^2 x}{\partial y \partial z} + q^2 \frac{\partial^2 x}{\partial z^2} \right). \quad (3)$$

代入原方程, 得

$$\begin{aligned} & \frac{\partial^2 z}{\partial x^2} \frac{\partial^2 z}{\partial y^2} - \left(\frac{\partial^2 z}{\partial x \partial y} \right)^2 = p^2 \left(p^2 \frac{\partial^2 x}{\partial z^2} \right) \\ & \cdot \left(\frac{\partial^2 x}{\partial y^2} + 2q \frac{\partial^2 x}{\partial y \partial z} + q^2 \frac{\partial^2 x}{\partial z^2} \right) \\ & - p^2 \left(p \frac{\partial^2 x}{\partial y \partial z} + pq \frac{\partial^2 x}{\partial z^2} \right)^2 \\ & = p^4 \left[\frac{\partial^2 x}{\partial y^2} \frac{\partial^2 x}{\partial z^2} - \left(\frac{\partial^2 x}{\partial y \partial z} \right)^2 \right] = 0, \end{aligned}$$

即

$$\frac{\partial^2 x}{\partial y^2} \frac{\partial^2 x}{\partial z^2} - \left(\frac{\partial^2 x}{\partial y \partial z} \right)^2 = 0.$$

类似地, 若以 y 作为函数, 则也有

$$\frac{\partial^2 y}{\partial x^2} \frac{\partial^2 y}{\partial z^2} - \left(\frac{\partial^2 y}{\partial x \partial z} \right)^2 = 0,$$

即方程的形状与变量 x , y 和 z 所分别担任的角色无关.

3526. 取 x 作为变量 y 和 z 的函数, 解方程

$$\begin{aligned} & \left(\frac{\partial z}{\partial y} \right)^2 \frac{\partial^2 z}{\partial x^2} - 2 \frac{\partial z}{\partial x} \frac{\partial z}{\partial y} \frac{\partial^2 z}{\partial x \partial y} \\ & + \left(\frac{\partial z}{\partial x} \right)^2 \frac{\partial^2 z}{\partial y^2} = 0. \end{aligned}$$

解 将 3525 题中的(1), (2), (3)三式及 $p = \frac{\partial z}{\partial x}$,

$q = \frac{\partial z}{\partial y}$ 代入, 得

$$\begin{aligned} & q^2 \left(-p^3 \frac{\partial^2 x}{\partial z^2} \right) + 2pq \left(p^2 \frac{\partial^2 x}{\partial y \partial z} + p^2 q \frac{\partial^2 x}{\partial z^2} \right) \\ & - p^2 \left(p \frac{\partial^2 x}{\partial y^2} + 2pq \frac{\partial^2 x}{\partial y \partial z} + pq^2 \frac{\partial^2 x}{\partial z^2} \right) \\ & = -p^3 \frac{\partial^2 x}{\partial y^2} = 0, \end{aligned}$$

即 $\frac{\partial^2 x}{\partial y^2} = 0$ 或 $p = 0$. 由

$$\frac{\partial^2 x}{\partial y^2} = 0$$

解之，得原方程的解为

$$x = \varphi(z)y + \psi(z),$$

其中 φ, ψ 为任意函数；由 $p=0$ 解之，得 $z=f(y)$

(f 为任意函数)，它也是原方程的解。

3527⁺. 运用勒襄德变换

$$X = \frac{\partial z}{\partial x}, \quad Y = \frac{\partial z}{\partial y}, \quad Z = x \frac{\partial z}{\partial x} + y \frac{\partial z}{\partial y} - z,$$

其中 $Z = Z(X, Y)$ ，变换方程

$$\begin{aligned} & A\left(\frac{\partial z}{\partial x}, \frac{\partial z}{\partial y}\right) \frac{\partial^2 z}{\partial x^2} + 2B\left(\frac{\partial z}{\partial x}, \frac{\partial z}{\partial y}\right) \frac{\partial^2 z}{\partial x \partial y} \\ & + C\left(\frac{\partial z}{\partial x}, \frac{\partial z}{\partial y}\right) \frac{\partial^2 z}{\partial y^2} = 0. \end{aligned}$$

解 $dZ = d\left(x \frac{\partial z}{\partial x} + y \frac{\partial z}{\partial y} - z\right)$

$$\begin{aligned} & = \frac{\partial z}{\partial x} dx + \frac{\partial z}{\partial y} dy - dz + x dX + y dY \\ & = x dX + y dY. \end{aligned}$$

于是，

$$\frac{\partial Z}{\partial X} = x, \quad \frac{\partial Z}{\partial Y} = y.$$

微分上式，得

$$\begin{cases} dx = \frac{\partial^2 Z}{\partial X^2} dX + \frac{\partial^2 Z}{\partial X \partial Y} dY, \\ dy = \frac{\partial^2 Z}{\partial X \partial Y} dX + \frac{\partial^2 Z}{\partial Y^2} dY. \end{cases} \quad (1)$$

又由 $X = \frac{\partial z}{\partial x}$, $Y = \frac{\partial z}{\partial y}$ 微分得

$$\begin{cases} dX = \frac{\partial^2 z}{\partial x^2} dx + \frac{\partial^2 z}{\partial x \partial y} dy, \\ dY = \frac{\partial^2 z}{\partial x \partial y} dx + \frac{\partial^2 z}{\partial y^2} dy. \end{cases} \quad (2)$$

由 (1) 式与 (2) 式, 得

$$\begin{aligned} \begin{pmatrix} dx \\ dy \end{pmatrix} &= \begin{pmatrix} \frac{\partial^2 Z}{\partial X^2} & \frac{\partial^2 Z}{\partial X \partial Y} \\ \frac{\partial^2 Z}{\partial X \partial Y} & \frac{\partial^2 Z}{\partial Y^2} \end{pmatrix} \begin{pmatrix} dX \\ dY \end{pmatrix} \\ &= \begin{pmatrix} \frac{\partial^2 Z}{\partial X^2} & \frac{\partial^2 Z}{\partial X \partial Y} \\ \frac{\partial^2 Z}{\partial X \partial Y} & \frac{\partial^2 Z}{\partial Y^2} \end{pmatrix} \begin{pmatrix} \frac{\partial^2 z}{\partial x^2} & \frac{\partial^2 z}{\partial x \partial y} \\ \frac{\partial^2 z}{\partial x \partial y} & \frac{\partial^2 z}{\partial y^2} \end{pmatrix} \begin{pmatrix} dx \\ dy \end{pmatrix}, \end{aligned}$$

由此可知

$$\begin{pmatrix} \frac{\partial^2 Z}{\partial X^2} & \frac{\partial^2 Z}{\partial X \partial Y} \\ \frac{\partial^2 Z}{\partial X \partial Y} & \frac{\partial^2 Z}{\partial Y^2} \end{pmatrix} \begin{pmatrix} \frac{\partial^2 z}{\partial x^2} & \frac{\partial^2 z}{\partial x \partial y} \\ \frac{\partial^2 z}{\partial x \partial y} & \frac{\partial^2 z}{\partial y^2} \end{pmatrix} = \begin{pmatrix} 1 & 0 \\ 0 & 1 \end{pmatrix},$$

从而

$$\begin{vmatrix} \frac{\partial^2 Z}{\partial X^2} & \frac{\partial^2 Z}{\partial X \partial Y} \\ \frac{\partial^2 Z}{\partial X \partial Y} & \frac{\partial^2 Z}{\partial Y^2} \end{vmatrix} \cdot \begin{vmatrix} \frac{\partial^2 z}{\partial x^2} & \frac{\partial^2 z}{\partial x \partial y} \\ \frac{\partial^2 z}{\partial x \partial y} & \frac{\partial^2 z}{\partial y^2} \end{vmatrix} = 1,$$

因此

$$I = \begin{vmatrix} \frac{\partial^2 Z}{\partial X^2} & \frac{\partial^2 Z}{\partial X \partial Y} \\ \frac{\partial^2 Z}{\partial X \partial Y} & \frac{\partial^2 Z}{\partial Y^2} \end{vmatrix} \neq 0.$$

于是，由 (1) 式解之，得

$$\begin{cases} dX = I^{-1} \left(\frac{\partial^2 Z}{\partial Y^2} dx - \frac{\partial^2 Z}{\partial X \partial Y} dy \right), \\ dY = I^{-1} \left(-\frac{\partial^2 Z}{\partial X \partial Y} dx + \frac{\partial^2 Z}{\partial X^2} dy \right). \end{cases} \quad (3)$$

比较 (2) 式与 (3) 式，得

$$\frac{\partial^2 z}{\partial x^2} = I^{-1} \frac{\partial^2 Z}{\partial Y^2}, \quad \frac{\partial^2 z}{\partial x \partial y} = -I^{-1} \frac{\partial^2 Z}{\partial X \partial Y},$$

$$\frac{\partial^2 z}{\partial y^2} = I^{-1} \frac{\partial^2 Z}{\partial X^2}.$$

代入原方程，即得

$$\begin{aligned} & A(X, Y) \frac{\partial^2 Z}{\partial Y^2} - 2B(X, Y) \frac{\partial^2 Z}{\partial X \partial Y} \\ & + C(X, Y) \frac{\partial^2 Z}{\partial X^2} = 0. \end{aligned}$$

§5. 几何上的应用

1° 切线和法平面 在曲线

$$x = \varphi(t), \quad y = \psi(t), \quad z = \chi(t)$$

上的一点 $M(x, y, z)$ 的切线方程为

$$\frac{X-x}{\frac{dx}{dt}} = \frac{Y-y}{\frac{dy}{dt}} = \frac{Z-z}{\frac{dz}{dt}}.$$

在此点的法平面方程为

$$\frac{dx}{dt}(X-x) + \frac{dy}{dt}(Y-y) + \frac{dz}{dt}(Z-z) = 0.$$

2° 切平面和法线 曲面 $z = f(x, y)$ 上点 $M(x, y, z)$

处的切平面方程为

$$Z-z = \frac{\partial z}{\partial x}(X-x) + \frac{\partial z}{\partial y}(Y-y).$$

在 M 点处的法线方程为

$$\frac{X-x}{\frac{\partial z}{\partial x}} = \frac{Y-y}{\frac{\partial z}{\partial y}} = \frac{Z-z}{-1}.$$

若曲面的方程给成隐函数的形状 $F(x, y, z) = 0$, 则切平面方程为:

$$\frac{\partial F}{\partial x}(X-x) + \frac{\partial F}{\partial y}(Y-y) + \frac{\partial F}{\partial z}(Z-z) = 0,$$

法线方程为

$$\frac{X-x}{\frac{\partial F}{\partial x}} = \frac{Y-y}{\frac{\partial F}{\partial y}} = \frac{Z-z}{\frac{\partial F}{\partial z}}.$$

3° 平面曲线族的包线 含一个参数的曲线族 $f(x, y, \alpha) = 0$ (α 为参数) 的包线满足方程组:

$$f(x, y, \alpha) = 0, f'_\alpha(x, y, \alpha) = 0.$$

4° 曲面族的包面 含一个参数的曲面族 $F(x, y, z, \alpha) = 0$ 的包面满足方程组:

$$F(x, y, z, \alpha) = 0, F'_\alpha(x, y, z, \alpha) = 0.$$

在含两个参数的曲面族 $\Phi(x, y, z, \alpha, \beta) = 0$ 的情形, 其包面满足下面的方程组:

$$\begin{aligned} \Phi(x, y, z, \alpha, \beta) &= 0, \Phi'_\alpha(x, y, z, \alpha, \beta) = 0, \\ \Phi'_\beta(x, y, z, \alpha, \beta) &= 0. \end{aligned}$$

对下列曲线写出在已知点的切线和法平面方程:

3528. $x = a \cos \alpha \cos t, y = a \sin \alpha \cos t, z = a \sin t$; 在点 $t = t_0$.

解 曲线

$$x = x(t), y = y(t), z = z(t)$$

在点 $t = t_0$ 的切向量为

$$\vec{v}(t_0) = \{x'(t_0), y'(t_0), z'(t_0)\}.$$

本题中, 当 $t = t_0$ 时曲线上点的坐标及曲线在该点的切向量分别为

$$x_0 = x(t_0) = a \cos \alpha \cos t_0,$$

$$y_0 = y(t_0) = a \sin \alpha \cos t_0,$$

$$z_0 = z(t_0) = a \sin t_0,$$

$$\vec{v}(t_0) = \{-a \cos \alpha \sin t_0, -a \sin \alpha \sin t_0, a \cos t_0\}.$$

于是, 切线方程为

$$\frac{x-x_0}{-a \cos \alpha \sin t_0} = \frac{y-y_0}{-a \sin \alpha \sin t_0} = \frac{z-z_0}{a \cos t_0},$$

即

$$\frac{x-x_0}{-\cos \alpha \sin t_0} = \frac{y-y_0}{-\sin \alpha \sin t_0} = \frac{z-z_0}{\cos t_0};$$

法平面方程为

$$(-a \cos \alpha \sin t_0)(x-x_0) + (-a \sin \alpha \sin t_0)(y-y_0) + (a \cos t_0)(z-z_0) = 0,$$

以 x_0, y_0, z_0 的值代入上式, 化简整理得

$$x \cos \alpha \sin t_0 + y \sin \alpha \sin t_0 - z \cos t_0 = 0,$$

即法平面过原点.

3529. $x = a \sin^2 t, y = b \sin t \cos t, z = c \cos^2 t$; 在点 $t = \frac{\pi}{4}$.

$$\text{解 } x_0 = a \sin^2 \frac{\pi}{4} = \frac{a}{2}, y_0 = \frac{b}{2}, z_0 = \frac{c}{2};$$

$$\vec{v}\left(\frac{\pi}{4}\right) = \{a, 0, -c\}.$$

于是, 切线方程为

$$\begin{cases} \frac{x - \frac{a}{2}}{a} = \frac{z - \frac{c}{2}}{-c}, \\ y = \frac{b}{2}; \end{cases} \quad \text{或} \quad \begin{cases} \frac{x}{a} + \frac{z}{c} = 1, \\ y = \frac{b}{2}; \end{cases}$$

法平面方程为

$$a\left(x - \frac{a}{2}\right) + (-c)\left(z - \frac{c}{2}\right) = 0,$$

即

$$ax - cz = \frac{1}{2}(a^2 - c^2).$$

3530. $y = x, z = x^2$; 在点 $M(1, 1, 1)$.

解 设 $x = t$, 则 $y = t, z = t^2$. 于是,

$$\vec{v}(1) = \{1, 1, 2\},$$

切线方程为

$$\frac{x-1}{1} = \frac{y-1}{1} = \frac{z-1}{2};$$

法平面方程为

$$(x-1) + (y-1) + 2(z-1) = 0 \text{ 或 } x + y + 2z = 4.$$

3531. $x^2 + z^2 = 10, y^2 + z^2 = 10$; 在点 $M(1, 1, 3)$.

解 当曲线以两个曲面方程

$$F_1(x, y, z) = 0, F_2(x, y, z) = 0$$

交线形式给出时, 可先求出两曲面在交点处的法向量:

$$\vec{n}_1 = \{F'_{1x}, F'_{1y}, F'_{1z}\}, \vec{n}_2 = \{F'_{2x}, F'_{2y}, F'_{2z}\},$$

则曲线在该点的切向量为

$$\vec{n} = \vec{n}_1 \times \vec{n}_2 = \left\{ \begin{vmatrix} F'_{1y} & F'_{1z} \\ F'_{2y} & F'_{2z} \end{vmatrix}, \begin{vmatrix} F'_{1x} & F'_{1z} \\ F'_{2x} & F'_{2z} \end{vmatrix}, \begin{vmatrix} F'_{1x} & F'_{1y} \\ F'_{2x} & F'_{2y} \end{vmatrix} \right\}.$$

本题中,

$$\vec{n}_1 = \{2, 0, 6\}, \quad \vec{n}_2 = \{0, 2, 6\},$$

$$\vec{v} = \{1, 0, 3\} \times \{0, 1, 3\} = \{-3, -3, 1\}.$$

于是, 切线方程为

$$\frac{x-1}{-3} = \frac{y-1}{-3} = \frac{z-3}{1}$$

或
$$\frac{x-1}{3} = \frac{y-1}{3} = \frac{z-3}{-1};$$

法平面方程为

$$-3(x-1) - 3(y-1) + (z-3) = 0,$$

即

$$3x + 3y - z = 3.$$

3532. $x^2 + y^2 + z^2 = 6$, $x + y + z = 0$; 在点 $M(1, -2, 1)$.

解 $F_1 = x^2 + y^2 + z^2 - 6 = 0$, $F_2 = x + y + z = 0$.

$$\vec{n}_1 = 2\{1, -2, 1\}, \quad \vec{n}_2 = \{1, 1, 1\},$$

$$\vec{v} = \{1, -2, 1\} \times \{1, 1, 1\}$$

$$= -3\{1, 0, -1\}.$$

于是, 切线方程为

$$\begin{cases} \frac{x-1}{1} = \frac{z-1}{-1}, & \text{或} \\ y = -2; & \begin{cases} x+z=2, \\ y+2=0; \end{cases} \end{cases}$$

法平面方程为

$$(x-1) - (z-1) = 0 \text{ 或 } x - z = 0.$$

3533. 在曲线 $x=t$, $y=t^2$, $z=t^3$ 上求出一点, 此点的切线是平行于平面 $x+2y+z=4$ 的.

解 $\vec{v} = \{1, 2t, 3t^2\}$, 平面法向量 $\vec{n} = \{1, 2, 1\}$.

按题设, 应有

$$\vec{v} \cdot \vec{n} = 1 + 4t + 3t^2 = 0.$$

解之, 得 $t = -1$ 或 $t = -\frac{1}{3}$. 于是, 所求的点为 M_1

$$(-1, 1, -1), M_2\left(-\frac{1}{3}, \frac{1}{9}, -\frac{1}{27}\right).$$

3534. 证明: 螺旋线 $x = a \cos t, y = a \sin t, z = bt$ 的切线与 Oz 轴形成定角.

证 $\frac{dx}{dt} = -a \sin t, \frac{dy}{dt} = a \cos t, \frac{dz}{dt} = b$. 于是, 切

线与 Oz 轴形成之角 γ 的余弦

$$\begin{aligned} \cos \gamma &= \frac{\frac{dz}{dt}}{\sqrt{\left(\frac{dx}{dt}\right)^2 + \left(\frac{dy}{dt}\right)^2 + \left(\frac{dz}{dt}\right)^2}} \\ &= \frac{b}{\sqrt{a^2 + b^2}}. \end{aligned}$$

由于 $\cos \gamma$ 为常数, 故知切线与 Oz 轴形成定角.

3535. 证明: 曲线

$$x = ae^t \cos t, y = ae^t \sin t, z = ae^t$$

与锥面 $x^2 + y^2 = z^2$ 的各母线相交的角度相同.

证 圆锥 $x^2 + y^2 = z^2$ 的顶点在原点, 过圆锥上任一点 $P(x, y, z)$ 的母线也过原点. 因此, 母线的方向向量为 $\vec{v}_1 = \{x, y, z\}$.

曲线在点 P 的切向量为 $\vec{v}_2 = \{x', y', z'\} = \{ae^t \cdot (\cos t - \sin t), ae^t (\sin t + \cos t), ae^t\} = \{x - y, x + y,$

z}.

注意到 $x^2 + y^2 = z^2$, 即得

$$\begin{aligned}\cos(\vec{v}_1, \vec{v}_2) &= \frac{\vec{v}_1 \cdot \vec{v}_2}{|\vec{v}_1| |\vec{v}_2|} \\ &= \frac{x(x-y) + y(x+y) + z^2}{\sqrt{x^2 + y^2 + z^2} \sqrt{(x-y)^2 + (x+y)^2 + z^2}} \\ &= \frac{2z^2}{\sqrt{2z^2} \sqrt{3z^2}} = \frac{2}{\sqrt{6}},\end{aligned}$$

于是, 交角相同.

3536. 证明斜驶线

$$\operatorname{tg}\left(\frac{\pi}{4} + \frac{\psi}{2}\right) = e^{k\varphi} \quad (k = \text{常数}),$$

(其中 φ —— 地球上点的经度, ψ —— 地球上点的纬度) 与地球的一切子午线相交成定角.

证 取直角坐标系如下: 赤道平面为 Oxy 平面, 球心为坐标原点, Ox 轴正向过 0° 子午线, Oz 轴正向过北极, 并取 $Oxyz$ 坐标系为右手系.

下面我们先确定斜驶线和子午线在直角坐标系中的方程. 为此, 假定讨论地球上的点的经度为 φ ($0 \leq \varphi \leq 2\pi$), 纬度为 ψ ($-\frac{\pi}{2} \leq \psi \leq \frac{\pi}{2}$), 则它在上述坐标系下的坐标为

$$\begin{cases} x = R \cos \psi \cos \varphi, \\ y = R \cos \psi \sin \varphi, \\ z = R \sin \psi, \end{cases}$$

其中 R 为地球半径.

对 $\operatorname{tg}\left(\frac{\pi}{4} + \frac{\psi}{2}\right) = e^{k\varphi}$ 的两端微分, 得

$$\frac{d\psi}{2\cos^2\left(\frac{\pi}{4} + \frac{\psi}{2}\right)} = ke^{k\varphi}d\varphi = k\operatorname{tg}\left(\frac{\pi}{4} + \frac{\psi}{2}\right)d\varphi.$$

于是,

$$\begin{aligned}\frac{d\varphi}{d\psi} &= \left[2\cos^2\left(\frac{\pi}{4} + \frac{\psi}{2}\right)k\operatorname{tg}\left(\frac{\pi}{4} + \frac{\psi}{2}\right)\right]^{-1} \\ &= \left[k\sin\left(\frac{\pi}{2} + \psi\right)\right]^{-1} = \frac{1}{k\cos\psi}.\end{aligned}$$

今将斜驶线方程看作决定 φ 为 ψ 的隐函数. 因此, 对斜驶线来说, 在 (φ_0, ψ_0) 点, 有

$$\begin{aligned}\frac{dx}{d\psi} &= -R\sin\psi_0\cos\varphi_0 - R\cos\psi_0\sin\varphi_0\frac{d\varphi}{d\psi} \\ &= -R\left(\sin\psi_0\cos\varphi_0 + \frac{\sin\varphi_0}{k}\right).\end{aligned}$$

$$\begin{aligned}\frac{dy}{d\psi} &= -R\sin\psi_0\sin\varphi_0 + R\cos\psi_0\cos\varphi_0\frac{d\varphi}{d\psi} \\ &= -R\left(\sin\psi_0\sin\varphi_0 - \frac{\cos\varphi_0}{k}\right),\end{aligned}$$

$$\frac{dz}{d\psi} = R\cos\psi_0.$$

于是, 可取斜驶线切向量

$$\vec{v}_1 = \left\{ \sin\psi_0\cos\varphi_0 + \frac{\sin\varphi_0}{k}, \sin\psi_0\sin\varphi_0 \right.$$

$$\left. -\frac{\cos\varphi_0}{k}, -\cos\psi_0 \right\}.$$

当 φ 为常数时即得子午线, 故其参数方程为

$$\begin{cases} x = R \cos\psi \cos\varphi_0, \\ y = R \cos\psi \sin\varphi_0, \\ z = R \sin\psi. \end{cases}$$

于是, 子午线在点 (φ_0, ψ_0) 的切向量为

$$\vec{v}_2 = \{\sin\psi_0 \cos\varphi_0, \sin\psi_0 \sin\varphi_0, -\cos\psi_0\}.$$

从而得

$$\cos(\vec{v}_1, \vec{v}_2) = \frac{\vec{v}_1 \cdot \vec{v}_2}{|\vec{v}_1| |\vec{v}_2|} = \frac{1}{\sqrt{1 + \frac{1}{k_2^2}}} = \text{常数},$$

即斜驶线与子午线相交成定角.

3537. 已知曲线

$$z = f(x, y), \quad \frac{x - x_0}{\cos\alpha} = \frac{y - y_0}{\sin\alpha},$$

其中 f 为可微分函数. 求曲线上 $M_0(x_0, y_0)$ 点的切线与 Oxy 平面所成角的正切.

解 解法一

将曲线看作由参数方程

$$x = x, \quad y = \varphi(x) = y_0 + (x - x_0) \operatorname{tg}\alpha, \quad z = \psi(x)$$

及 $f(x, \varphi(x))$ 给出, 则切向量为

$$\begin{aligned} \vec{v} &= \{1, \varphi'(x_0), \psi'(x_0)\} \\ &= \{1, \operatorname{tg}\alpha, f'_x[x_0, \varphi(x_0)] \\ &\quad + f'_y[x_0, \varphi(x_0)]\varphi'(x_0)\} \end{aligned}$$

$$= \{1, \operatorname{tg} \alpha, f'_x(x_0, y_0) + \operatorname{tg} \alpha \cdot f'_y(x_0, y_0)\}.$$

于是, 曲线上 M_0 点的切线与 Oxy 平面所成角 φ 的正切为

$$\begin{aligned} \operatorname{tg} \varphi &= \frac{\psi'(x_0)}{\sqrt{1 + \varphi'^2(x_0)}} = \frac{f'_x(x_0, y_0) + \operatorname{tg} \alpha \cdot f'_y(x_0, y_0)}{\sqrt{1 + \operatorname{tg}^2 \alpha}} \\ &= f'_x(x_0, y_0) \cos \alpha + f'_y(x_0, y_0) \sin \alpha. \end{aligned}$$

解法二

将曲线看作两条曲线的交线, 则所给曲线在 M_0 点的切线方程为

$$\begin{aligned} \frac{x - x_0}{\begin{vmatrix} f'_x(x_0, y_0) & -1 \\ -\frac{1}{\sin \alpha} & 0 \end{vmatrix}} &= \frac{y - y_0}{\begin{vmatrix} -1 & f'_x(x_0, y_0) \\ 0 & \frac{1}{\cos \alpha} \end{vmatrix}} \\ &= \frac{z - z_0}{\begin{vmatrix} f'_x(x_0, y_0) & f'_y(x_0, y_0) \\ \frac{1}{\cos \alpha} & -\frac{1}{\sin \alpha} \end{vmatrix}}, \end{aligned}$$

即

$$\frac{x - x_0}{\cos \alpha} = \frac{y - y_0}{\sin \alpha} = \frac{z - z_0}{f'_x(x_0, y_0) \cos \alpha + f'_y(x_0, y_0) \sin \alpha},$$

因此, 切线与 Oxy 平面所成角 φ 的正切为

$$\begin{aligned} \operatorname{tg} \varphi &= \frac{f'_x(x_0, y_0) \cos \alpha + f'_y(x_0, y_0) \sin \alpha}{\sqrt{\cos^2 \alpha + \sin^2 \alpha}} \\ &= f'_x(x_0, y_0) \cos \alpha + f'_y(x_0, y_0) \sin \alpha. \end{aligned}$$

3538. 求函数

$$u = \frac{x}{\sqrt{x^2 + y^2 + z^2}}$$

在点 $M(1, 2, -2)$ 沿曲线

$$x=t, y=2t^2, z=-2t^4$$

在此点的切线方向上的导函数.

解
$$\frac{\partial u}{\partial x} = \frac{y^2 + z^2}{(x^2 + y^2 + z^2)^{\frac{3}{2}}},$$

$$\frac{\partial u}{\partial y} = -\frac{xy}{(x^2 + y^2 + z^2)^{\frac{3}{2}}},$$

$$\frac{\partial u}{\partial z} = -\frac{xz}{(x^2 + y^2 + z^2)^{\frac{3}{2}}}.$$

在点 $M(1, 2, -2)$ 它们的值分别为 $\frac{8}{27}$, $-\frac{2}{27}$, $\frac{2}{27}$.

又曲线在该点的切线的方向余弦为 $\frac{1}{9}$, $\frac{4}{9}$, $-\frac{8}{9}$.

于是, 所求的导数为

$$\left. \frac{\partial u}{\partial t} \right|_M = \frac{8}{27} \cdot \frac{1}{9} + \left(-\frac{2}{27}\right) \cdot \frac{4}{9} + \frac{2}{27} \cdot \left(-\frac{8}{9}\right) = -\frac{16}{243}.$$

写出下列曲面上已知点的切面和法线方程:

3539. $z = x^2 + y^2$; 在点 $M_0(1, 2, 5)$.

解 当曲面由方程 $F(x, y, z) = 0$ 给出时, 法向量

为 $\vec{n} = \left\{ \frac{\partial F}{\partial x}, \frac{\partial F}{\partial y}, \frac{\partial F}{\partial z} \right\}$; 特别是曲面由显式方程

$z=f(x, y)$ 给出时, 法向量为 $\vec{n}=\{f'_x, f'_y, -1\}$.

本题中, $\vec{n}=\{2x, 2y, -1\}_{M_0}=\{2, 4, -1\}$.

于是, 切面方程为

$$2(x-1)+4(y-2)-(z-5)=0,$$

或

$$2x+4y-z=5;$$

法线方程为

$$\frac{x-1}{2}=\frac{y-2}{4}=\frac{z-5}{-1}.$$

3540. $x^2+y^2+z^2=169$; 在点 $M_0(3, 4, 12)$.

解 设 $F(x, y, z)=x^2+y^2+z^2-169=0$, 则在点

M_0 处 $\vec{n}=\{2x, 2y, 2z\}_{M_0}=\{6, 8, 24\}=2\{3, 4,$

$12\}$. 于是, 切面方程为

$$3(x-3)+4(y-4)+12(z-12)=0$$

或

$$3x+4y+12z=169;$$

法线方程为

$$\frac{x-3}{3}=\frac{y-4}{4}=\frac{z-12}{12} \text{ 或 } \frac{x}{3}=\frac{y}{4}=\frac{z}{12}.$$

3541. $z=\arctg \frac{y}{x}$; 在点 $M_0(1, 1, \frac{\pi}{4})$.

解 $\vec{n}=\left\{\frac{-y}{x^2+y^2}, \frac{x}{x^2+y^2}, -1\right\}_{M_0}=\left\{-\frac{1}{2}, \frac{1}{2},$

$-1\}$. 于是, 切面方程为

$$z - \frac{\pi}{4} = -\frac{1}{2}(x-1) + \frac{1}{2}(y-1)$$

或
$$z = \frac{\pi}{4} - \frac{1}{2}(x-y);$$

法线方程为

$$\frac{x-1}{1} = \frac{y-1}{-1} = \frac{z - \frac{\pi}{4}}{2}.$$

3542. $ax^2 + by^2 + cz^2 = 1$; 在点 $M_0(x_0, y_0, z_0)$.

解 $\vec{n} = 2\{ax_0, by_0, cz_0\}$. 于是, 切面方程为

$$ax_0(x-x_0) + by_0(y-y_0) + cz_0(z-z_0) = 0,$$

注意到 $ax_0^2 + by_0^2 + cz_0^2 = 1$, 上述方程即化为

$$ax_0x + by_0y + cz_0z = 1;$$

法线方程为

$$\frac{x-x_0}{ax_0} = \frac{y-y_0}{by_0} = \frac{z-z_0}{cz_0}.$$

3543. $z = y + \ln \frac{x}{z}$; 在点 $M_0(1, 1, 1)$.

解 $F(x, y, z) = y + \ln x - \ln z - z = 0$.

$$\vec{n} = \left\{ \frac{1}{x}, 1, -\frac{1}{z} - 1 \right\}_{M_0} = \{1, 1, -2\}.$$

于是, 切面方程为

$$(x-1) + (y-1) - 2(z-1) = 0 \text{ 或 } x + y - 2z = 0;$$

法线方程为

$$\frac{x-1}{1} = \frac{y-1}{1} = \frac{z-1}{-2}.$$

3544. $2^{\frac{x}{z}} + 2^{\frac{y}{z}} = 8$; 在点 $M_0(2, 2, 1)$.

解 $F(x, y, z) = 2^{\frac{x}{z}} + 2^{\frac{y}{z}} - 8$,

$$\vec{n} = \left\{ \frac{1}{z} 2^{\frac{x}{z}} \ln 2, \frac{1}{z} 2^{\frac{y}{z}} \ln 2, \left(x \cdot 2^{\frac{x}{z}} \right. \right.$$

$$\left. \left. + y \cdot 2^{\frac{y}{z}} \right) \left(-\frac{1}{z^2} \ln 2 \right) \right\}_{M_0}$$

$$= 4 \ln 2 \{ 1, 1, -4 \}.$$

于是, 切面方程为

$$(x-2) + (y-2) - 4(z-1) = 0 \text{ 或 } x + y - 4z = 0;$$

法线方程为

$$\frac{x-2}{1} = \frac{y-2}{1} = \frac{z-1}{-4}.$$

3545. $x = a \cos \psi \cos \varphi$, $y = b \cos \psi \sin \varphi$, $z = c \sin \psi$; 在点 $M_0(\varphi_0, \psi_0)$.

解 当曲面由参数方程

$$x = x(u, v), \quad y = y(u, v), \quad z = z(u, v)$$

给出时, 曲面上分别令 $u = u_0$, $v = v_0$ 得到的两条曲线的切向量分别为

$$\vec{v}_1 = \left\{ \frac{\partial x}{\partial u}, \frac{\partial y}{\partial u}, \frac{\partial z}{\partial u} \right\},$$

$$\vec{v}_2 = \left\{ \frac{\partial x}{\partial v}, \frac{\partial y}{\partial v}, \frac{\partial z}{\partial v} \right\},$$

则切面的法向量为

$$\vec{n} = \vec{v}_1 \times \vec{v}_2 = \left\{ \begin{vmatrix} \frac{\partial y}{\partial u} & \frac{\partial z}{\partial u} \\ \frac{\partial y}{\partial v} & \frac{\partial z}{\partial v} \end{vmatrix}, \begin{vmatrix} \frac{\partial z}{\partial u} & \frac{\partial x}{\partial u} \\ \frac{\partial z}{\partial v} & \frac{\partial x}{\partial v} \end{vmatrix}, \begin{vmatrix} \frac{\partial x}{\partial u} & \frac{\partial y}{\partial u} \\ \frac{\partial x}{\partial v} & \frac{\partial y}{\partial v} \end{vmatrix} \right\}.$$

本题中,

$$\begin{aligned} \vec{v}_1 &= \left\{ \frac{\partial x}{\partial \varphi}, \frac{\partial y}{\partial \varphi}, \frac{\partial z}{\partial \varphi} \right\}_{M_0} \\ &= \{-a \cos \psi_0 \sin \varphi_0, b \cos \psi_0 \cos \varphi_0, 0\} \\ &= \cos \psi_0 \{-a \sin \varphi_0, b \cos \varphi_0, 0\}, \end{aligned}$$

$$\begin{aligned} \vec{v}_2 &= \left\{ \frac{\partial x}{\partial \psi}, \frac{\partial y}{\partial \psi}, \frac{\partial z}{\partial \psi} \right\}_{M_0} \\ &= \{-a \sin \psi_0 \cos \varphi_0, -b \sin \psi_0 \sin \varphi_0, c \cos \psi_0\}, \end{aligned}$$

$$\begin{aligned} \vec{n} &= \vec{v}_1 \times \vec{v}_2 \\ &= abc \left\{ \frac{\cos \psi_0 \cos \varphi_0}{a}, \frac{\cos \psi_0 \sin \varphi_0}{b}, \frac{\sin \psi_0}{c} \right\}. \end{aligned}$$

于是, 切面方程为

$$\begin{aligned} &\frac{\cos \psi_0 \cos \varphi_0}{a} (x - a \cos \psi_0 \cos \varphi_0) + \frac{\cos \psi_0 \sin \varphi_0}{b} \\ &\cdot (y - b \cos \psi_0 \sin \varphi_0) \\ &+ \frac{\sin \psi_0}{c} (z - c \sin \psi_0) = 0, \end{aligned}$$

即

$$\frac{x}{a} \cos \psi_0 \cos \varphi_0 + \frac{y}{b} \cos \psi_0 \sin \varphi_0 + \frac{z}{c} \sin \psi_0 = 1;$$

法线方程为

$$\frac{x - a \cos \psi_0 \cos \varphi_0}{\cos \psi_0 \cos \varphi_0} = \frac{y - b \cos \psi_0 \sin \varphi_0}{\cos \psi_0 \sin \varphi_0} = \frac{z - c \sin \psi_0}{\sin \psi_0},$$

即

$$\frac{x \sec \psi_0 \sec \varphi_0 - a}{bc} = \frac{y \sec \psi_0 \csc \varphi_0 - b}{ac} = \frac{z \csc \psi_0 - c}{ab}.$$

3546. $x = r \cos \varphi$, $y = r \sin \varphi$, $z = r \operatorname{ctg} \alpha$; 在点 $M_0(\varphi_0, r_0)$.

解 $\vec{v}_1 = \left\{ \frac{\partial x}{\partial \varphi}, \frac{\partial y}{\partial \varphi}, \frac{\partial z}{\partial \varphi} \right\}_{M_0}$

$$= r_0 \{-\sin \varphi_0, \cos \varphi_0, 0\},$$

$$\vec{v}_2 = \left\{ \frac{\partial x}{\partial r}, \frac{\partial y}{\partial r}, \frac{\partial z}{\partial r} \right\}_{M_0}$$

$$= \{\cos \varphi_0, \sin \varphi_0, \operatorname{ctg} \alpha\},$$

$$\vec{n} = \vec{v}_1 \times \vec{v}_2 = r_0 \{\cos \varphi_0 \operatorname{ctg} \alpha, \sin \varphi_0 \operatorname{ctg} \alpha, -1\}.$$

于是, 切面方程为

$$\cos \varphi_0 \operatorname{ctg} \alpha (x - r_0 \cos \varphi_0) + \sin \varphi_0 \operatorname{ctg} \alpha (y - r_0 \sin \varphi_0) - (z - r_0 \operatorname{ctg} \alpha) = 0.$$

即

$$x \cos \varphi_0 + y \sin \varphi_0 - z \operatorname{ctg} \alpha = 0;$$

法线方程为

$$\frac{x - r_0 \cos \varphi_0}{\cos \varphi_0 \operatorname{ctg} \alpha} = \frac{y - r_0 \sin \varphi_0}{\sin \varphi_0 \operatorname{ctg} \alpha} = \frac{z - r_0 \operatorname{ctg} \alpha}{-1}$$

或

$$\frac{x - r_0 \cos \varphi_0}{\cos \varphi_0} = \frac{y - r_0 \sin \varphi_0}{\sin \varphi_0} = \frac{z - r_0 \operatorname{ctg} \alpha}{-\operatorname{tg} \alpha}.$$

3547. $x = u \cos v$, $y = u \sin v$, $z = av$; 在点 $M_0(u_0, v_0)$.

解 $\vec{v}_1 = \left\{ \frac{\partial x}{\partial u}, \frac{\partial y}{\partial u}, \frac{\partial z}{\partial u} \right\}_{M_0} = \{ \cos v_0, \sin v_0, 0 \},$

$$\vec{v}_2 = \left\{ \frac{\partial x}{\partial v}, \frac{\partial y}{\partial v}, \frac{\partial z}{\partial v} \right\}_{M_0}$$

$$= \{ -u_0 \sin v_0, u_0 \cos v_0, a \},$$

$$\vec{n} = \vec{v}_1 \times \vec{v}_2 = \{ a \sin v_0, -a \cos v_0, u_0 \}.$$

于是, 切面方程为

$$a \sin v_0 (x - u_0 \cos v_0) - a \cos v_0 (y - u_0 \sin v_0) + u_0 (z - av_0) = 0,$$

即

$$ax \sin v_0 - ay \cos v_0 + u_0 z = au_0 v_0;$$

法线方程为

$$\frac{x - u_0 \cos v_0}{a \sin v_0} = \frac{y - u_0 \sin v_0}{-a \cos v_0} = \frac{z - av_0}{u_0}.$$

3548. 求曲面

$$x = u + v, \quad y = u^2 + v^2, \quad z = u^3 + v^3$$

的切平面当切点 $M(u, v)$ ($u \neq v$) 无限接近于曲面的边界线 $u = v$ 上的点 $M_0(u_0, v_0)$ 时的极限位置.

解 $\vec{n}(u, v) = \{1, 2u, 3u^2\} \times \{1, 2v, 3v^2\}$
 $= (v - u) \{6uv, -3(u + v), 2\},$

则 \vec{n} 方向上的单位向量为

$$\vec{n}^0(u, v) = \left\{ \frac{6uv}{l}, -\frac{3(u+v)}{l}, \frac{2}{l} \right\},$$

其中 $l = \sqrt{36u^2v^2 + 9(u+v)^2 + 4}$. 于是

$$\lim_{\substack{u \rightarrow u_0 \\ v \rightarrow v_0}} \vec{n}^0 = \left\{ \frac{6u_0^2}{l_0}, -\frac{6u_0}{l_0}, \frac{2}{l_0} \right\},$$

其中 $l_0 = \sqrt{36u_0^4 + 36u_0^2 + 4}$. 而 $M_0(u_0, v_0)$

$= (2u_0, 2u_0^2, 2u_0^3)$, 故知切面在 M_0 点的极限位置为

$$\begin{aligned} & 3u_0^2x - 3u_0y + z \\ &= 3u_0^2(2u_0) - 3u_0(2u_0^2) + 2u_0^3 \\ &= 2u_0^3, \end{aligned}$$

或

$$\frac{3x}{u_0} - \frac{3y}{u_0^2} + \frac{z}{u_0^3} = 2.$$

3549. 在曲面 $x^2 + 2y^2 + 3z^2 + 2xy + 2xz + 4yz = 8$ 上求出切平面平行于坐标平面的诸切点.

解 $\vec{n} = \{2(x+y+z), 2(x+2y+2z), 2(x+2y+3z)\}$. 当

$$\begin{cases} x+y+z=0, \\ x+2y+2z=0, \\ x+2y+3z=\lambda \end{cases}$$

时, \vec{n} 与 $\vec{k} = \{0, 0, 1\}$ 平行, 即切面平行于 Oxy 平面. 解之, 得 $x=0, y=-\lambda, z=\lambda$. 将求得的 x, y, z 值代入所给的曲面方程, 得 $\lambda = \pm 2\sqrt{2}$. 于是, 切面平行于 Oxy 坐标平面的切点为 $(0, \pm 2\sqrt{2}, \pm 2\sqrt{2})$.

$\mp 2\sqrt{2}$). 同法可求得切面平行于 Oyz 坐标平面及 Oxz 坐标平面的诸切点分别为 $(\pm 4, \mp 2, 0)$ 及 $(\pm 2, \mp 4, \pm 2)$.

3550. 在椭球面

$$\frac{x^2}{a^2} + \frac{y^2}{b^2} + \frac{z^2}{c^2} = 1$$

上怎样的点, 椭球面的法线与坐标轴成等角?

解 $\vec{n} = 2 \left\{ \frac{x}{a^2}, \frac{y}{b^2}, \frac{z}{c^2} \right\}$. 按题设, 应有

$$\frac{\frac{x}{a^2}}{l} = \frac{\frac{y}{b^2}}{l} = \frac{\frac{z}{c^2}}{l} \quad \left(l = \sqrt{\frac{x^2}{a^4} + \frac{y^2}{b^4} + \frac{z^2}{c^4}} \right),$$

即

$$\frac{x}{a^2} = \frac{y}{b^2} = \frac{z}{c^2} = \lambda.$$

将上式代入椭球面方程, 得 $\lambda = \pm \frac{1}{\sqrt{a^2 + b^2 + c^2}}$.

于是, 所求的点为 $x = \pm \frac{a^2}{d}$, $y = \pm \frac{b^2}{d}$, $z = \pm \frac{c^2}{d}$,

其中 $d = \sqrt{a^2 + b^2 + c^2}$.

3551. 求曲面 $x^2 + 2y^2 + 3z^2 = 21$ 的平行于平面

$$x + 4y + 6z = 0$$

的各切平面.

解 $\vec{n} = 2\{x, 2y, 3z\}$. 按题设, 应有

$$x = \lambda, \quad 2y = 4\lambda, \quad 3z = 6\lambda,$$

解之, 得 $x = \lambda$, $y = 2\lambda$, $z = 2\lambda$. 将它们代入方程

$x^2 + 2y^2 + 3z^2 = 21$, 得 $\lambda = \pm 1$, 故切点为 $(\pm 1, \pm 2, \pm 2)$. 于是, 所求的切面方程为

$$(x \mp 1) + 4(y \mp 2) + 6(z \mp 2) = 0,$$

即

$$x + 4y + 6z = \pm 21.$$

3552. 证明: 曲面 $xyz = a^3$ ($a > 0$) 的切平面与坐标面形成体积一定的四面体.

证 在曲面上任取一点 $P_0(x_0, y_0, z_0)$, 则曲面在该点的切平面方程为

$$y_0 z_0 (x - x_0) + x_0 z_0 (y - y_0) + x_0 y_0 (z - z_0) = 0,$$

它与各坐标面的交点为 $A(3x_0, 0, 0)$, $B(0, 3y_0, 0)$, $C(0, 0, 3z_0)$. 注意到各坐标轴的垂直关系, 即知以 A 、 B 、 C 、 O 诸点为顶点的四面体的体积为

$$\begin{aligned} V_{ABCO} &= \frac{1}{3} OC \cdot \left(\frac{1}{2} OA \cdot OB \right) \\ &= \frac{1}{6} 3z_0 \cdot 3x_0 \cdot 3y_0 = \frac{9}{2} x_0 y_0 z_0 = \frac{9}{2} a^3, \end{aligned}$$

它为一个常数, 本题获证.

3553. 证明: 曲面

$$\sqrt{x} + \sqrt{y} + \sqrt{z} = \sqrt{a} \quad (a > 0)$$

的切平面在坐标轴上割下的诸线段, 其和为常量.

证 在曲面上任取一点 $P_0(x_0, y_0, z_0)$, 则曲面在该点的切平面方程为

$$\frac{1}{2\sqrt{x_0}}(x - x_0) + \frac{1}{2\sqrt{y_0}}(y - y_0) + \frac{1}{2\sqrt{z_0}}(z - z_0) = 0$$

$$+\frac{1}{2\sqrt{z_0}}(z-z_0)=0,$$

即

$$\sqrt{y_0 z_0}(x-x_0)+\sqrt{x_0 z_0}(y-y_0)+\sqrt{x_0 y_0} \cdot (z-z_0)=0.$$

此切面在坐标轴上所割下的诸线段分别为

$$\sqrt{ax_0}, \sqrt{ay_0}, \sqrt{az_0},$$

其和为 $\sqrt{a}(\sqrt{x_0}+\sqrt{y_0}+\sqrt{z_0})=\sqrt{a} \cdot \sqrt{a}=a$, 它是常数, 本题获证.

3554. 证明: 锥面

$$z=xf\left(\frac{y}{x}\right)$$

的切平面经过其顶点.

证 $\frac{\partial z}{\partial x}=f\left(\frac{y}{x}\right)-\frac{y}{x}f'\left(\frac{y}{x}\right)$, $\frac{\partial z}{\partial y}=f'\left(\frac{y}{x}\right)$. 于是,

锥面在任一点 $P_0(x_0, y_0, z_0)$ 的切面方程为

$$z-z_0=\left[f\left(\frac{y_0}{x_0}\right)-\frac{y_0}{x_0}f'\left(\frac{y_0}{x_0}\right)\right](x-x_0) \\ +f'\left(\frac{y_0}{x_0}\right)(y-y_0),$$

化简整理得

$$z=\left[f\left(\frac{y_0}{x_0}\right)-\frac{y_0}{x_0}f'\left(\frac{y_0}{x_0}\right)\right]x+f'\left(\frac{y_0}{x_0}\right)y,$$

它显然通过锥面 $z=xf\left(\frac{y}{x}\right)$ 的顶点 $(0, 0, 0)$.

3555. 证明: 旋转面

$$z = f(\sqrt{x^2 + y^2}) \quad (f' \neq 0)$$

的法线与旋转轴相交.

证 在旋转面上任取一点 $P_0(x_0, y_0, z_0)$, 其中 $z_0 = f(\sqrt{x_0^2 + y_0^2})$, 则曲面在该点的法向量为

$$\begin{aligned} \vec{n} &= \left\{ \frac{\partial f}{\partial x}, \frac{\partial f}{\partial y}, -1 \right\}_{P_0} = \frac{1}{\sqrt{x_0^2 + y_0^2}} \\ &\cdot \left\{ x_0 f', y_0 f', -\sqrt{x_0^2 + y_0^2} \right\}. \end{aligned}$$

于是, 法线方程为

$$\frac{x - x_0}{x_0 f'} = \frac{y - y_0}{y_0 f'} = \frac{z - z_0}{-\sqrt{x_0^2 + y_0^2}},$$

显然, 法线通过 Oz 轴上的点

$$\left(0, 0, f(\sqrt{x_0^2 + y_0^2}) + \frac{\sqrt{x_0^2 + y_0^2}}{f'(\sqrt{x_0^2 + y_0^2})} \right),$$

即法线和 Oz 轴相交.

3556. 求椭球面

$$x^2 + y^2 + z^2 - xy = 1$$

在坐标面上的射影.

解 先考虑椭球面 $x^2 + y^2 + z^2 - xy = 1$ 在 Oxy 平面上的射影. 该射影即通过所给曲面上的每一点向 Oxy 平面作垂线所得到的垂足的全体, 它是 Oxy 平面上的一个区域, 这个区域的边界由曲面上这样的点的投影构成: 这一点向 Oxy 平面所作的垂线在它的切面内 (这里用到了椭球面的凸性), 即该点的法线与 Oxy

平面平行。注意到该点的法向量为 $\{2x-y, 2y-x, 2z\}$ 。因此，该点的坐标满足

$$\begin{cases} 2z=0, \\ x^2+y^2+z^2-xy=1, \end{cases}$$

这些点的投影为

$$\begin{cases} z=0, \\ x^2+y^2-xy=1, \end{cases}$$

它即椭球面在 Oxy 平面上射影的边界。

同法可考虑切面与 Oxz 平面垂直，则有

$$2y-x=0.$$

因此，对 Oxz 平面投影为边界点的椭球面上的点应满足方程

$$\begin{cases} 2y-x=0, \\ x^2+y^2+z^2-xy=1. \end{cases}$$

这是椭球面与平面的交线，将它改写为柱面与平面的交线

$$\begin{cases} 2y-x=0, \\ \frac{3x^2}{4}+z^2=1. \end{cases}$$

于是，椭球面在 Oxz 平面上射影的边界由方程

$$\begin{cases} y=0, \\ \frac{3x^2}{4}+z^2=1 \end{cases}$$

所确定。

同法可确定椭球面在 Oyz 平面上射影的边界由

方程

$$\begin{cases} x = 0, \\ \frac{3y^2}{4} + z^2 = 1 \end{cases}$$

所确定.

于是, 椭球面 $x^2 + y^2 + z^2 - xy = 1$ 在 Oxy 平面上的射影为圆: $x^2 + y^2 - xy \leq 1, z = 0$; 在 Oyz 平面上的射影为椭圆: $\frac{3}{4}y^2 + z^2 \leq 1, x = 0$; 在 Oxz 平面上的射影为椭圆 $\frac{3}{4}x^2 + z^2 \leq 1, y = 0$.

3557. 分正方形 $\{0 \leq x \leq 1, 0 \leq y \leq 1\}$ 为直径 $\leq \delta$ 的有限个部分 σ . 若曲面

$$z = 1 - x^2 - y^2$$

在属于同一部分 σ 的任何两点 $P(x, y)$ 及 $P_1(x_1, y_1)$ 的法线方向相差小于 1° , 求数 δ 的上界.

解 记曲面在点 $P(x, y)$ 及 $P_1(x_1, y_1)$ 的法向量为 \vec{n} 及 \vec{n}_1 , 则 $\vec{n} = \{2x, 2y, 1\}$, $|\vec{n}| \geq 1$, $\vec{n}_1 = \{2x_1, 2y_1, 1\}$, $|\vec{n}_1| \geq 1$, 且有

$$\vec{n} \times \vec{n}_1 = \{2(y - y_1), 2(x_1 - x), 4(xy_1 - x_1y)\},$$

$$\sin(\widehat{\vec{n}, \vec{n}_1}) = \frac{|\vec{n} \times \vec{n}_1|}{|\vec{n}| |\vec{n}_1|} \leq |\vec{n} \times \vec{n}_1|$$

$$= 2 \sqrt{(y - y_1)^2 + (x - x_1)^2 + 4(xy_1 - x_1y)^2}.$$

注意到 $(xy_1 - x_1y)^2 = [x(y_1 - y) + y(x - x_1)]^2$

$$\leq 2[x^2(y_1 - y)^2 + y^2(x - x_1)^2]$$

$$\leq 2[(y - y_1)^2 + (x - x_1)^2],$$

并记 $\rho = \sqrt{(y - y_1)^2 + (x - x_1)^2}$, 即有

$$\widehat{\sin(n, n_1)} \leq 2\sqrt{\rho^2 + 4 \cdot 2\rho^2} = 6\rho.$$

当 $\varphi = \widehat{(n, n_1)} < 1^\circ$ 时, $\varphi \approx \widehat{\sin(n, n_1)}$. 于是, 要 $\varphi <$

$\frac{\pi}{180}$, 只要 $6\rho < \frac{\pi}{180}$, 即 $\rho < \frac{\pi}{1080} \approx 0.003$ 即可.

从而得

$$\delta < 0.003.$$

3558. 设:

$$z = f(x, y), \text{ 其中 } (x, y) \in D \quad (1)$$

为曲面的方程, $\varphi(P_1, P)$ 为曲面 (1) 在点 $P(x, y) \in D$ 及 $P_1(x_1, y_1) \in D$ 二点的法线之间的夹角.

证明: 若域 D 有界且为封闭的, 函数 $f(x, y)$ 在域 D 内有有界的二阶导函数, 则李雅甫诺夫不等式

$$\varphi(P_1, P) < C\rho(P_1, P) \quad (2)$$

成立. 其中 C 为常数, $\rho(P_1, P)$ 为点 P 与 P_1 之间的距离.

证 本题应加区域是凸的这个条件, 否则结论就不成立. 例如,

$$z = \begin{cases} 0, & \text{当 } y \leq 0, x^2 + y^2 \leq 1, \\ y^3, & \text{当 } y > 0, x \geq y^4, x^2 + y^2 \leq 1, \\ -y^3, & \text{当 } y > 0, x \leq -y^4, x^2 + y^2 \leq 1, \end{cases}$$

如图6·30所示, 函数 z 在单位圆内缺一个角的闭区域内定义, 且有连续的二

阶偏导函数, 取 $P_n\left(\frac{1}{n^3},$

$\frac{1}{n}\right)$ 与 $P'_n\left(-\frac{1}{n^3}, \frac{1}{n}\right)$, 则

$$\vec{n} = \vec{n}(P_n) = \{0, 3y^2,$$

$$-1\}_{P_n} = \left\{0, \frac{3}{n^2}, -1\right\},$$

$$\vec{n}' = \vec{n}(P'_n) = \{0, -3y^2, -1\}_{P'_n}$$

$$= \left\{0, -\frac{3}{n^2}, -1\right\},$$

$$\vec{n} \times \vec{n}' = \left\{-\frac{6}{n^2}, 0, 0\right\},$$

$$\sin \varphi_n = \frac{|\vec{n} \times \vec{n}'|}{|\vec{n}| |\vec{n}'|} = \frac{\frac{6}{n^2}}{1 + \frac{9}{n^4}} \rightarrow 0 \quad (n \rightarrow \infty).$$

又因

$$\rho_n(P_n, P'_n) = \frac{2}{n^3},$$

$$\lim_{n \rightarrow \infty} \frac{\varphi_n}{\rho_n} = \lim_{n \rightarrow \infty} \left(\frac{\sin \varphi_n}{\rho_n} \cdot \frac{\varphi_n}{\sin \varphi_n} \right) = \lim_{n \rightarrow \infty} \frac{\sin \varphi_n}{\rho_n}$$



图 6·30

$$= \lim_{n \rightarrow \infty} \frac{\frac{\frac{6}{n^2}}{1 + \frac{9}{n^4}}}{\frac{2}{n^3}} = +\infty,$$

故不存在常数 C , 使 $\varphi_n < C\rho_n$.

下面证明当 D 为凸的有界闭域时, 不等式(2)为真.

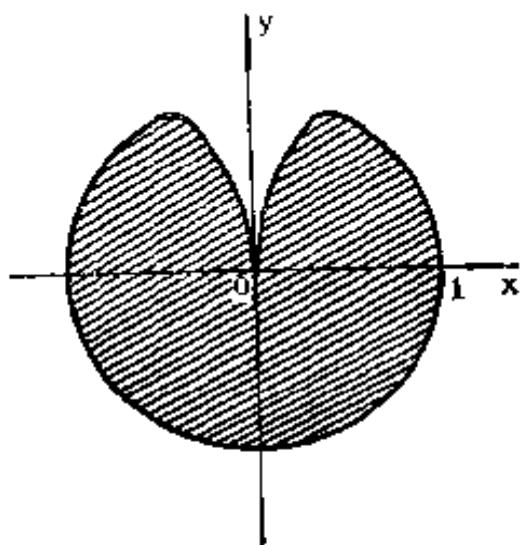
由 3253 题知: 当 $f(x, y)$ 在 D 内有二阶连续的偏导函数时, $\frac{\partial f}{\partial x}$ 及 $\frac{\partial f}{\partial y}$ 在 D 内是二元连续的. 又因 D 是有界闭域, 故 $\frac{\partial f}{\partial x}$ 及 $\frac{\partial f}{\partial y}$ 在 D 上有界, 记

$$\left| \frac{\partial f}{\partial x} \right| < M, \quad \left| \frac{\partial f}{\partial y} \right| < M.$$

又由 3254 题的证明过程可知: 当 D 是凸域, $f(x, y)$ 有有界二阶偏导函数时, 对 D 中任意两点 P 及 P_1 ,

$\frac{\partial f}{\partial x}$ 及 $\frac{\partial f}{\partial y}$ 满足里普什兹条件, 即存在常数 L , 使有

$$\left| \frac{\partial f(P)}{\partial x} - \frac{\partial f(P_1)}{\partial x} \right| < L\rho(P_1, P),$$

$$\left| \frac{\partial f(P)}{\partial y} - \frac{\partial f(P_1)}{\partial y} \right| < L\rho(P_1, P).$$

$$\bar{n}(P_1) = \left\{ \frac{\partial f(P_1)}{\partial x}, \frac{\partial f(P_1)}{\partial y}, -1 \right\}$$

及 $\vec{n}(P) = \left\{ \frac{\partial f(P)}{\partial x}, \frac{\partial f(P)}{\partial y}, -1 \right\}$ 知: 对于 $\varphi = \varphi$

(P_1, P) 有下列不等式

$$\begin{aligned} \sin^2 \varphi &= \frac{|\vec{n}(P_1) \times \vec{n}(P)|^2}{|\vec{n}(P_1)|^2 |\vec{n}(P)|^2} \leq |\vec{n}(P_1) \times \vec{n}(P)|^2 \\ &= \left[\frac{\partial f(P)}{\partial y} - \frac{\partial f(P_1)}{\partial y} \right]^2 + \left[\frac{\partial f(P)}{\partial x} - \frac{\partial f(P_1)}{\partial x} \right]^2 \\ &\quad + \left[\frac{\partial f(P_1)}{\partial x} \frac{\partial f(P)}{\partial y} - \frac{\partial f(P_1)}{\partial y} \frac{\partial f(P)}{\partial x} \right]^2 \\ &\leq L^2 \rho^2 + L^2 \rho^2 + 2 \left[\frac{\partial f(P_1)}{\partial x} \right]^2 \\ &\quad \cdot \left[\frac{\partial f(P)}{\partial y} - \frac{\partial f(P_1)}{\partial y} \right]^2 \\ &\quad + 2 \left[\frac{\partial f(P_1)}{\partial y} \right]^2 \left[\frac{\partial f(P_1)}{\partial x} - \frac{\partial f(P)}{\partial x} \right]^2 \\ &\leq 2L^2 \rho^2 + 2M^2 L^2 \rho^2 + 2M^2 L^2 \rho^2 \\ &= 2L^2 \rho^2 (1 + 2M^2). \end{aligned}$$

于是,

$$\sin \varphi \leq C_1 \rho(P_1, P),$$

其中 $C_1^2 = 2L^2(1 + 2M^2)$, 从而得

$$\begin{aligned} \varphi(P_1, P) &\leq \frac{\pi}{2} \sin \varphi^* \leq \frac{\pi}{2} C_1 \rho(P_1, P) \\ &= C \rho(P_1, P), \end{aligned}$$

其中 $C = \frac{\pi}{2} C_1$ 为常数, 本题获证.

*) 利用 1290 题的结果.

3559. 圆柱 $x^2 + y^2 = a^2$ 与曲面 $bz = xy$ 在公共点 $M_0(x_0, y_0, z_0)$ 相交成怎样的角?

解 二曲面在 M_0 点的法向量为

$$\vec{n}_1 = \{y_0, x_0, -b\} \text{ 及 } \vec{n}_2 = \{2x_0, 2y_0, 0\}.$$

于是, 交角 φ 满足

$$\begin{aligned} \cos \varphi &= \frac{\vec{n}_1 \cdot \vec{n}_2}{|\vec{n}_1| |\vec{n}_2|} = \frac{2x_0y_0 + 2x_0y_0 + 0}{\sqrt{x_0^2 + y_0^2 + b^2} \sqrt{4x_0^2 + 4y_0^2}} \\ &= \frac{4bz_0}{\sqrt{a^2 + b^2} \cdot 2a} = \frac{2bz_0}{a\sqrt{a^2 + b^2}}. \end{aligned}$$

3560. 证明: 球坐标的坐标曲面 $x^2 + y^2 + z^2 = r^2$, $y = x \operatorname{tg} \varphi$, $x^2 + y^2 = z^2 \operatorname{tg}^2 \theta$ 两两相交.

证 各曲面在其交点 $P(x, y, z)$ 处的法向量分别为

$$\vec{n}_1 = \{2x, 2y, 2z\}, \vec{n}_2 = \{\operatorname{tg} \varphi, -1, 0\},$$

$$\vec{n}_3 = \{2x, 2y, -2z \operatorname{tg}^2 \theta\}.$$

由于

$$\vec{n}_1 \cdot \vec{n}_2 = 2x \operatorname{tg} \varphi - 2y = 2y - 2y = 0,$$

$$\vec{n}_1 \cdot \vec{n}_3 = 4x^2 + 4y^2 - 4z^2 \operatorname{tg}^2 \theta = 4z^2 \operatorname{tg}^2 \theta$$

$$- 4z^2 \operatorname{tg}^2 \theta = 0,$$

$$\vec{n}_2 \cdot \vec{n}_3 = 2x \operatorname{tg} \varphi - 2y = 0,$$

故知这些曲面在其交点处分别两两直交.

3561. 证明: 球 $x^2 + y^2 + z^2 = 2ax$, $x^2 + y^2 + z^2 = 2by$, $x^2 + y^2 + z^2 = 2cz$ 形成三直交系.

证 设球 $x^2 + y^2 + z^2 = 2ax$ 与球 $x^2 + y^2 + z^2 = 2by$ 交于 $P_0(x_0, y_0, z_0)$ 点, 则它们在 P_0 点的法向量为

$$\vec{n}_1 = \{2(x_0 - a), 2y_0, 2z_0\},$$

$$\vec{n}_2 = \{2x_0, 2(y_0 - b), 2z_0\}.$$

由于

$$\begin{aligned} \vec{n}_1 \cdot \vec{n}_2 &= 4[x_0(x_0 - a) + y_0(y_0 - b) + z_0^2] \\ &= 2[2x_0^2 + 2y_0^2 + 2z_0^2 - 2ax_0 - 2by_0] \\ &= 2[(x_0^2 + y_0^2 + z_0^2 - 2ax_0) + (x_0^2 + y_0^2 \\ &\quad + z_0^2 - 2by_0)] = 0, \end{aligned}$$

故知这二球在其交点处直交, 同法可证其它球的两两直交性.

3562. 当 $\lambda = \lambda_1, \lambda = \lambda_2, \lambda = \lambda_3$ 时, 经过每一点 $M(x, y, z)$ 有三个二次曲面:

$$\frac{x^2}{a^2 - \lambda^2} + \frac{y^2}{b^2 - \lambda^2} + \frac{z^2}{c^2 - \lambda^2} = -1 \quad (a > b > c > 0).$$

证明这些曲面是直交的.

证 先证 $\lambda_i (i=1, 2, 3)$ 的存在性. 考虑 λ^2 的多项式

$$\begin{aligned} F(\lambda^2) &= x^2(b^2 - \lambda^2)(c^2 - \lambda^2) + y^2(a^2 - \lambda^2) \\ &\quad \cdot (c^2 - \lambda^2) + z^2(a^2 - \lambda^2)(b^2 - \lambda^2) \\ &\quad + (a^2 - \lambda^2)(b^2 - \lambda^2)(c^2 - \lambda^2). \end{aligned}$$

显然有

$$F(a^2) = x^2(b^2 - a^2)(c^2 - a^2) \geq 0,$$

$$F(b^2) = y^2(a^2 - b^2)(c^2 - b^2) \leq 0,$$

$$F(c^2) = z^2(a^2 - c^2)(b^2 - c^2) \geq 0,$$

$$\lim_{\lambda^2 \rightarrow +\infty} F(\lambda^2) = -\infty.$$

因此, $F(\lambda^2) = 0$ 在 $(a^2, +\infty), (b^2, a^2)$ 及 $(c^2,$

b^2)内各有一根, 记为 $\lambda_1^2, \lambda_2^2, \lambda_3^2$. 但 $F(\lambda^2)$ 是关于 λ^2 的三次多项式, 因此, 也仅有三个实根 λ_i^2 ($i=1, 2, 3$), 且知 $\lambda_i \neq \lambda_j$ ($i \neq j; i, j=1, 2, 3$). 由 $F(\lambda_i^2) = 0$ 不难推得

$$\frac{x^2}{a^2 - \lambda_i^2} + \frac{y^2}{b^2 - \lambda_i^2} + \frac{z^2}{c^2 - \lambda_i^2} = -1 \quad (i=1, 2, 3).$$

下面再证明这三个二次曲面是两两直交的, 由于

$$\vec{n}_i = \left\{ \frac{2x}{a^2 - \lambda_i^2}, \frac{2y}{b^2 - \lambda_i^2}, \frac{2z}{c^2 - \lambda_i^2} \right\} \quad (i=1, 2, 3),$$

及当 $i \neq j$ 时,

$$\begin{aligned} \vec{n}_i \cdot \vec{n}_j &= \frac{4x^2}{(a^2 - \lambda_i^2)(a^2 - \lambda_j^2)} + \frac{4y^2}{(b^2 - \lambda_i^2)(b^2 - \lambda_j^2)} \\ &\quad + \frac{4z^2}{(c^2 - \lambda_i^2)(c^2 - \lambda_j^2)} \\ &= \frac{4}{\lambda_i^2 - \lambda_j^2} \left[\left(\frac{x^2}{a^2 - \lambda_i^2} + \frac{y^2}{b^2 - \lambda_i^2} + \frac{z^2}{c^2 - \lambda_i^2} \right) \right. \\ &\quad \left. - \left(\frac{x^2}{a^2 - \lambda_j^2} + \frac{y^2}{b^2 - \lambda_j^2} + \frac{z^2}{c^2 - \lambda_j^2} \right) \right] \\ &= \frac{4}{\lambda_i^2 - \lambda_j^2} [(-1) - (-1)] = 0. \end{aligned}$$

故本题获证.

3563. 求函数 $u = x + y + z$ 在沿球面 $x^2 + y^2 + z^2 = 1$ 上 $M_0(x_0, y_0, z_0)$ 点的外法线方向上的导函数.

在球面上怎样的点使得上述的导函数有：(a) 最大值，(b) 最小值，(B) 等于零？

解 $r_0 = \sqrt{x_0^2 + y_0^2 + z_0^2} = 1$ ，则在 M_0 点处球面的外法线单位向量为 $\left\{ \frac{x_0}{r_0}, \frac{y_0}{r_0}, \frac{z_0}{r_0} \right\} = \{x_0, y_0, z_0\}$ 。

于是，

$$\begin{aligned} \frac{\partial u}{\partial n} &= \left\{ \frac{\partial u}{\partial x}, \frac{\partial u}{\partial y}, \frac{\partial u}{\partial z} \right\} \cdot \{x_0, y_0, z_0\} \\ &= \{1, 1, 1\} \cdot \{x_0, y_0, z_0\} = x_0 + y_0 + z_0. \end{aligned}$$

(a) 利用 1294 题的结果，得

$$\begin{aligned} x_0 + y_0 + z_0 &= 1 \cdot x_0 + 1 \cdot y_0 + 1 \cdot z_0 \\ &\leq \sqrt{3} \sqrt{x_0^2 + y_0^2 + z_0^2} = \sqrt{3}. \end{aligned}$$

当 $x_0 = y_0 = z_0 = \frac{1}{\sqrt{3}}$ 时，上述等式成立，此点恰在

球面上。因此，在 $\left(\frac{1}{\sqrt{3}}, \frac{1}{\sqrt{3}}, \frac{1}{\sqrt{3}} \right)$ 点 $\frac{\partial u}{\partial n}$ 取得最大值。

(b) 同法可得

$$\begin{aligned} -(x_0 + y_0 + z_0) &= (-1)x_0 + (-1)y_0 \\ &+ (-1)z_0 \leq \sqrt{3}, \end{aligned}$$

或

$$x_0 + y_0 + z_0 \geq -\sqrt{3}.$$

故在点 $\left(-\frac{1}{\sqrt{3}}, -\frac{1}{\sqrt{3}}, -\frac{1}{\sqrt{3}} \right)$ ， $\frac{\partial u}{\partial n}$ 取得最小值。

(B) 当 $x+y+z=0$ 及 $x^2+y^2+z^2=1$ 时 $\frac{\partial u}{\partial n}=0$.

因此, 所求的点为由方程

$$\begin{cases} x+y+z=0, \\ x^2+y^2+z^2=1 \end{cases}$$

所确定的解 (x, y, z) , 它在单位球面与过圆心的平面 $x+y+z=0$ 的交线——圆上面.

3564. 求函数 $u=x^2+y^2+z^2$ 在沿椭球面 $\frac{x^2}{a^2}+\frac{y^2}{b^2}+\frac{z^2}{c^2}=1$ 上 $M_0(x_0, y_0, z_0)$ 点的外法线方向上的导函数.

解 $\vec{n}=\left\{\frac{2x_0}{a^2}, \frac{2y_0}{b^2}, \frac{2z_0}{c^2}\right\}$, 此法向量的单位向量

为 $\vec{n}^0=\left\{\frac{x_0}{a^2\Delta}, \frac{y_0}{b^2\Delta}, \frac{z_0}{c^2\Delta}\right\}$, 其中

$$\Delta=\sqrt{\frac{x_0^2}{a^4}+\frac{y_0^2}{b^4}+\frac{z_0^2}{c^4}}.$$

于是,

$$\begin{aligned} \left.\frac{\partial u}{\partial n}\right|_{M_0} &= \frac{x_0}{a^2\Delta} 2x_0 + \frac{y_0}{b^2\Delta} 2y_0 + \frac{z_0}{c^2\Delta} 2z_0 \\ &= \frac{2}{\Delta} \left(\frac{x_0^2}{a^2} + \frac{y_0^2}{b^2} + \frac{z_0^2}{c^2} \right) = \frac{2}{\Delta} \\ &= \frac{2}{\sqrt{\frac{x_0^2}{a^4} + \frac{y_0^2}{b^4} + \frac{z_0^2}{c^4}}}. \end{aligned}$$

3565. 设 $\frac{\partial u}{\partial n}$ 和 $\frac{\partial v}{\partial n}$ 为函数 u 和 v 在沿曲面 $F(x, y, z)=0$

上的点的法线方向上的导函数, 证明:

$$\frac{\partial}{\partial n}(uv) = u \frac{\partial v}{\partial n} + v \frac{\partial u}{\partial n}.$$

证 $\frac{\partial}{\partial n}(uv) = \frac{\partial}{\partial x}(uv) \cos \alpha$

$$+ \frac{\partial}{\partial y}(uv) \cos \beta + \frac{\partial}{\partial z}(uv) \cos \gamma$$

$$= u \left(\frac{\partial v}{\partial x} \cos \alpha + \frac{\partial v}{\partial y} \cos \beta + \frac{\partial v}{\partial z} \cos \gamma \right)$$

$$+ v \left(\frac{\partial u}{\partial x} \cos \alpha + \frac{\partial u}{\partial y} \cos \beta + \frac{\partial u}{\partial z} \cos \gamma \right)$$

$$= u \frac{\partial v}{\partial n} + v \frac{\partial u}{\partial n}.$$

求含一个参变数的平面曲线族的包线:

3566. $x \cos \alpha + y \sin \alpha = p$ ($p = \text{常数}$).

解 $\begin{cases} f(x, y, \alpha) = x \cos \alpha + y \sin \alpha - p = 0, \\ f'_\alpha(x, y, \alpha) = -x \sin \alpha + y \cos \alpha = 0. \end{cases}$

消去 α , 得

$$x^2 + y^2 = p^2. \quad (1)$$

由于原曲线族没有奇点, 且(1)也不是原曲线族中的某一支, 故(1)为原曲线族的包线方程.

3567. $(x-a)^2 + y^2 = \frac{a^2}{2}.$

$$\text{解} \quad \begin{cases} (x-a)^2 + y^2 - \frac{a^2}{2} = 0, \\ 2(x-a) + a = 0. \end{cases}$$

消去 a , 得 $y = \pm x$, 同 3566 题的理由可知, 它是包线方程.

$$3568. \quad y = kx + \frac{a}{k} \quad (a = \text{常数}).$$

$$\text{解} \quad \begin{cases} kx - y + \frac{a}{k} = 0, \\ x - \frac{a}{k^2} = 0. \end{cases}$$

消去 k , 得 $y^2 = 4ax$, 同 3566 题的理由可知, 它是包线方程.

$$3569. \quad y^2 = 2px + p^2.$$

$$\text{解} \quad \begin{cases} 2px - y^2 + p^2 = 0, \\ x + p = 0. \end{cases}$$

消去 p , 得 $x^2 + y^2 = 0$, 它仅为一点 $(0, 0)$. 于是, 原曲线族无包线.

3570. 设有长为 l 的线段, 其两端点沿坐标轴滑动, 求如此产生的线段族的包线.

解 如图 6.31 所示, 直线方程为



图 6.31

$$\frac{x}{a} + \frac{y}{b} = 1.$$

但是 $a = l \sin \theta$, $b = l \cos \theta$, 所以,

$$\frac{x}{\sin \theta} + \frac{y}{\cos \theta} = l. \quad (1)$$

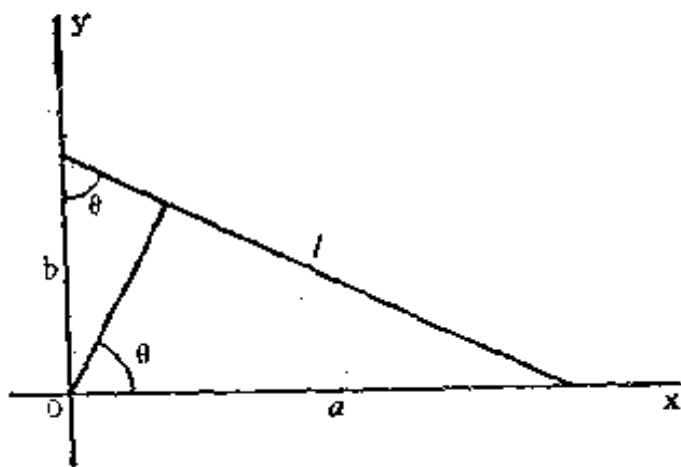
对 θ 求导数, 得

$$-\frac{x}{\sin^2 \theta} \cos \theta + \frac{y}{\cos^2 \theta} \sin \theta = 0$$

或
$$\frac{x}{\sin^3 \theta} = \frac{y}{\cos^3 \theta}. \quad (2)$$

由(1), (2) 消去 θ , 得 $x^{\frac{2}{3}} + y^{\frac{2}{3}} = l^{\frac{2}{3}}$, 同 3566 题的理由可知, 它是包线方程.

3571. 求椭圆族 $\frac{x^2}{a^2} + \frac{y^2}{b^2} = 1$ 的包线, 已知此族中椭圆的面积 S 为常数.

解 由题设 $\pi ab = S$, 得 $a = \frac{S}{\pi b}$, 且

$$\frac{\pi^2 b^2 x^2}{S^2} + \frac{y^2}{b^2} = 1. \quad (1)$$

对 b 求导数, 得

$$\frac{2\pi^2 b x^2}{S^2} - \frac{2y^2}{b^3} = 0. \quad (2)$$

由(2)式 $b^4 = \frac{y^2 S^2}{\pi^2 x^2}$ 或 $b^2 = \pm \frac{yS}{\pi x}$. 再代入(1), 得

$$\pm \frac{\pi xy}{S} \pm \frac{\pi xy}{S} = 1, \text{ 即}$$

$$|xy| = \frac{S}{2\pi},$$

同 3566 题的理由可知，它是包线方程。

3572. 炮弹在真空中以初速度 v_0 射出，当投射角 α 在铅垂平面中变化下，求炮弹轨道的包线。

解 炮弹轨道方程为

$$y = x \operatorname{tg} \alpha - \frac{gx^2}{2v_0^2 \cos^2 \alpha}. \quad (1)$$

对 α 求导数，得

$$0 = \frac{x}{\cos^2 \alpha} - \frac{gx^2 \sin \alpha}{v_0^2 \cos^3 \alpha}. \quad (2)$$

由(2)式得 $\operatorname{tg} \alpha = \frac{v_0^2}{xg}$ 。代入(1)式，得

$$\begin{aligned} y &= x \operatorname{tg} \alpha - \frac{gx^2}{2v_0^2 \cos^2 \alpha} = x \frac{v_0^2}{xg} - \frac{gx^2}{2v_0^2} \left(1 + \frac{v_0^4}{x^2 g^2} \right) \\ &= \frac{v_0^2}{2g} - \frac{gx^2}{2v_0^2}, \end{aligned}$$

同 3566 题的理由可知，它是包线方程。

3573. 证明：平面曲线的法线的包线是此曲线的渐屈线。

证 这里我们仅就由显式 $y=f(x)$ 所给出的平面曲线情形加以证明。

曲线 $y=f(x)$ 在点 $P(x, y)$ 的法线方程为

$$(X-x) + y'(Y-y) = 0, \quad (1)$$

对 x 求导数, 得

$$-1 + y''(Y - y) - y'^2 = 0$$

或

$$y''(Y - y) = 1 + y'^2. \quad (2)$$

由(1), (2)解得

$$\begin{cases} X = x - \frac{y'(1 + y'^2)}{y''}, \\ Y = y + \frac{1 + y'^2}{y''}, \end{cases}$$

此即 $y = f(x)$ 的渐屈线方程(参看第二章§14前言3°). 同 3566 题的理由可知, 它是平面曲线的法线的包线方程.

3574. 研究下列曲线族的判别曲线的性质 (c ——参变数):

(a) 立方抛物线 $y = (x - c)^3$;

(b) 半立方抛物线 $y^2 = (x - c)^3$;

(B) 奈尔半立方抛物线 $y^3 = (x - c)^2$;

(r) 环索线 $(y - c)^2 = x^2 \frac{a - x}{a + x}$.

$$\text{解 (a)} \begin{cases} f(x, y, c) = y - (x - c)^3 = 0, \\ f'_c(x, y, c) = 3(x - c)^2 = 0. \end{cases}$$

消去 c , 得 $y = 0$, 它为判别曲线的方程.

原曲线无奇点, 且 $y = 0$ 也不是原曲线族的某一支, 因此, 它是包线. 此包线与原曲线在 $(c, 0)$ 点相切, 且 $(c, 0)$ 点是曲线的拐点, 即它又是原曲线族拐点的轨迹. 如图6.32(1)所示.

$$(6) \begin{cases} y^2 - (x-c)^3 = 0, \\ 3(x-c)^2 = 0. \end{cases}$$

消去 c , 得判别曲线 $y=0$.

原曲线的奇点为 $(c, 0)$, 因此它是奇点的轨迹. 要看是否为包线, 还要看在奇点的两支是否与判别曲线相切. 事实上, 两支分别为 $y_1 = (x-c)^{\frac{3}{2}}$, $y_2 = -(x-c)^{\frac{3}{2}}$, 均有 $y'_1(c)=0$, $y'_2(c)=0$. 因此, $y=0$ 为原曲线族的包线. 如图 6·32(2) 所示.

$$(B) \begin{cases} y^3 - (x-c)^2 = 0, \\ 2(x-c) = 0. \end{cases}$$

消去 c , 得判别曲线 $y=0$.

原曲线的奇点为 $(c, 0)$. 由于 $y = (x-c)^{\frac{3}{2}}$ 在 $x=c$ 处的导数为无穷, 因此, 它与 $y=0$ 不相切, 从而它无包线. 奇点 $(c, 0)$ 为尖点. 如图 6·32(3) 所示.

$$(F) \begin{cases} (y-c)^2 - x^2 \frac{a-x}{a+x} = 0, \\ -2(y-c) = 0. \end{cases}$$

消去 c , 得 $x^2(a-x)=0$, 即判别曲线为直线 $x=0$ 及 $x=a$.

显然 $x=0$ 为原曲线族奇点的轨迹, 用 §6. 的方法可判别出它是二重点的轨迹. 事实上,

$$A = f''_{xx}(0, c) = 2, \quad B = f''_{xy}(0, c) = 0,$$

$$C = F''_{yy}(0, c) = -2, \quad AC - B^2 = -4 < 0.$$

从而知 $x=0$ 不是包线.

但是，在 $x=a$ 处 $f'_x(a, y) \neq 0$ ($a \neq 0$)，因此 $x=a$ 不是原曲线族奇点的轨迹，同时它又不是原曲线族的某一支。因此， $x=a$ 是原曲线族的包线，如图 6·32 (4) 所示。



图 6·32

3575. 求半径为 r ，中心在圆周 $x = R \cos t$ ， $y = R \sin t$ ， $z = 0$ (t —参数， $R > r$) 上的球族的包面。

解
$$\begin{cases} (X - R \cos t)^2 + (Y - R \sin t)^2 + Z^2 = r^2, & (1) \\ 2R \sin t (X - R \cos t) - 2R \cos t (Y - R \sin t) = 0. & (2) \end{cases}$$

(2)式化简得 $X \sin t - Y \cos t = 0$. 于是,

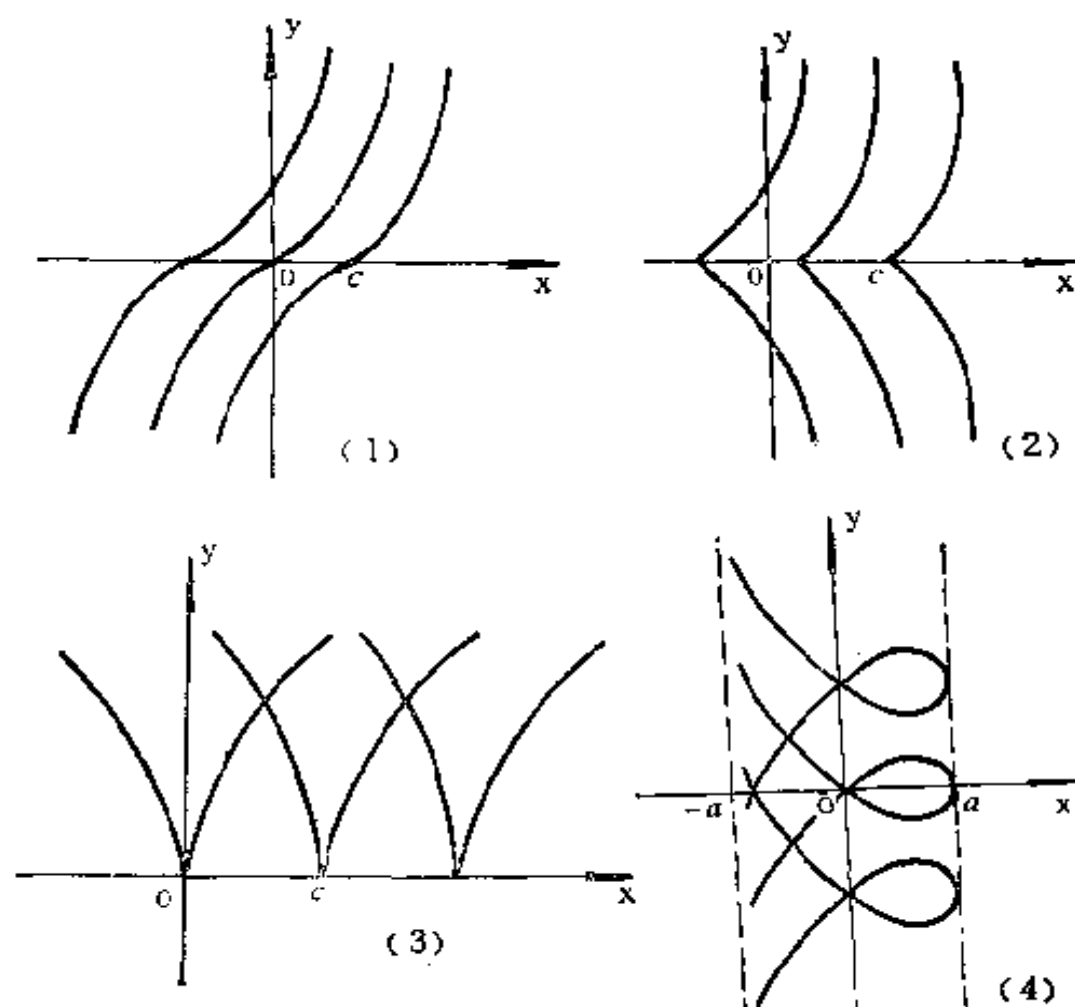
$$\operatorname{tg} t = \frac{Y}{X}, \quad \cos t = \pm \frac{X}{\sqrt{X^2 + Y^2}},$$

$$\sin t = \pm \frac{Y}{\sqrt{X^2 + Y^2}}, \quad (3)$$

将(3)式代入(1)式, 得

$$(X^2 + Y^2) \left(1 \pm \frac{R}{\sqrt{X^2 + Y^2}} \right)^2 + Z^2 = r^2.$$

当取“+”号时, 由于 $R^2 > r^2$, 故它不代表任何点(不是虚的)的轨迹.

当取“-”号时, 由于原曲面族无奇点, 且 $(\sqrt{X^2 + Y^2} - R)^2 + Z^2 = r^2$ 不是原曲面族的某一个, 因此, 它是原曲面族的包面(圆环).

3576. 求球族

$$(x - t \cos \alpha)^2 + (y - t \cos \beta)^2 + (z - t \cos \gamma)^2 = 1$$

(其中 $\cos^2 \alpha + \cos^2 \beta + \cos^2 \gamma = 1$ 及 t —参变数)的包面.

$$\text{解} \quad \begin{cases} (x - t \cos \alpha)^2 + (y - t \cos \beta)^2 \\ + (z - t \cos \gamma)^2 - 1 = 0, \end{cases} \quad (1)$$

$$\begin{cases} -2 \cos \alpha (x - t \cos \alpha) - 2 \cos \beta (y - t \cos \beta) \\ - 2 \cos \gamma (z - t \cos \gamma) = 0. \end{cases} \quad (2)$$

$$\text{由(2)得} \quad t = x \cos \alpha + y \cos \beta + z \cos \gamma. \quad (3)$$

将(3)式代入(1)式, 化简整理得

$$x^2 + y^2 + z^2 - (x \cos \alpha + y \cos \beta + z \cos \gamma)^2 = 1. \quad (4)$$

由于原曲面族的奇点均不在此方程所表示的曲面上, 并且曲面(4)也不是原曲面族中的某一个, 因此, 曲面(4)为原曲面族的包面.

3577. 求椭球面族 $\frac{x^2}{a^2} + \frac{y^2}{b^2} + \frac{z^2}{c^2} = 1$ 的包面, 这些椭球的体

积 V 是常数.

解 引入辅助函数

$$F(x, y, z, a, b, c) = \frac{x^2}{a^2} + \frac{y^2}{b^2} + \frac{z^2}{c^2} + \lambda abc,$$

则包面的方程由方程组

$$\left\{ \begin{array}{l} \frac{x^2}{a^2} + \frac{y^2}{b^2} + \frac{z^2}{c^2} = 1, \end{array} \right. \quad (1)$$

$$\left\{ \begin{array}{l} abc = \frac{3V}{4\pi}, \end{array} \right. \quad (2)$$

$$\left\{ \begin{array}{l} F'_a = -\frac{2x^2}{a^3} + \lambda bc = 0, \end{array} \right. \quad (3)$$

$$\left\{ \begin{array}{l} F'_b = -\frac{2y^2}{b^3} + \lambda ac = 0, \end{array} \right. \quad (4)$$

$$\left\{ \begin{array}{l} F'_c = -\frac{2z^2}{c^3} + \lambda ab = 0 \end{array} \right. \quad (5)$$

确定.

由(3)、(4)、(5)可解得

$$\frac{x^2}{a^2} = \frac{y^2}{b^2} = \frac{z^2}{c^2} = \frac{\lambda abc}{2} = \mu. \quad (6)$$

将(6)式代入(1)式, 得

$$\frac{x^2}{a^2} = \frac{y^2}{b^2} = \frac{z^2}{c^2} = \mu = \frac{1}{3}.$$

于是,

$$a = \sqrt{3}|x|, \quad b = \sqrt{3}|y|, \quad c = \sqrt{3}|z|. \quad (7)$$

将(7)式代入(2)式, 得

$$|xyz| = \frac{V}{4\pi\sqrt{3}}. \quad (8)$$

由于原曲面族无奇点, 且曲面(8)也不是原曲面族中的某一个, 故知曲面(8)为原曲面族的包面.

3578. 求半径为 ρ , 中心在圆锥面 $x^2 + y^2 = z^2$ 上的球族的包面.

解 设球心为 (a, b, c) , 则球的方程为

$$(x-a)^2 + (y-b)^2 + (z-c)^2 = \rho^2,$$

其中 $a^2 + b^2 = c^2$.

引入辅助函数

$$F(x, y, z, a, b, c) = (x-a)^2 + (y-b)^2 + (z-c)^2 + \lambda(a^2 + b^2 - c^2),$$

则包面方程由方程组

$$\begin{cases} (x-a)^2 + (y-b)^2 + (z-c)^2 = \rho^2, & (1) \end{cases}$$

$$\begin{cases} a^2 + b^2 = c^2, & (2) \end{cases}$$

$$\begin{cases} F'_a = -2(x-a) + 2\lambda a = 0, & (3) \end{cases}$$

$$\begin{cases} F'_b = -2(y-b) + 2\lambda b = 0, & (4) \end{cases}$$

$$\begin{cases} F'_c = -2(z-c) - 2\lambda c = 0 & (5) \end{cases}$$

确定.

由(3)、(4)、(5)可得

$$\frac{x}{a} - 1 = \frac{y}{b} - 1 = -\frac{z}{c} + 1 = \lambda.$$

引入记号 $\frac{1}{\mu} = \frac{x}{a} = \frac{y}{b} = 2 - \frac{z}{c}$, 则有

$$a = \mu x, \quad b = \mu y, \quad c = \frac{\mu z}{2\mu - 1}. \quad (6)$$

將(6)式代入(1),(2)两式, 得

$$\begin{cases} x^2 + y^2 + \frac{z^2}{(2\mu - 1)^2} = \frac{\rho^2}{(\mu - 1)^2}, & (7) \\ x^2 + y^2 - \frac{z^2}{(2\mu - 1)^2} = 0. & (8) \end{cases}$$

(7)+(8)得

$$2(x^2 + y^2) = \frac{\rho^2}{(\mu - 1)^2}$$

或 $\sqrt{2} \rho = \sqrt{x^2 + y^2} |2\mu - 2|. \quad (9)$

由(8)得 $2\mu - 1 = \pm \frac{z}{\sqrt{x^2 + y^2}}. \quad (10)$

將(10)代入(9), 整理得

$$\sqrt{2} \rho = |\sqrt{x^2 + y^2} \pm z|. \quad (11)$$

由于原曲面族无奇点, 且曲面(11)也不是原曲面族的某一个. 因此, 曲面(11)为原曲面族的包面.

3579. 有一发光点位于坐标原点. 若 $x_0^2 + y_0^2 + z_0^2 > R^2$, 求由球

$$(x - x_0)^2 + (y - y_0)^2 + (z - z_0)^2 \leq R^2$$

投影所生成的阴影圆锥.

解 解法一.

所求的阴影圆锥的表面, 可看作是一个过原点的平面族的包面, 此平面族的方程为

$$ax + by + cz = 0,$$

其中 a, b, c 满足约束条件

$$\begin{cases} ax_0 + by_0 + cz_0 = \pm R, \\ a^2 + b^2 + c^2 = 1. \end{cases}$$

引进辅助函数

$$F(x, y, z, a, b, c) = ax + by + cz + \lambda(ax_0 + by_0 + cz_0) + \mu(a^2 + b^2 + c^2),$$

则包面方程由方程组

$$\begin{cases} ax + by + cz = 0, & (1) \\ a^2 + b^2 + c^2 = 1, & (2) \\ ax_0 + by_0 + cz_0 = \pm R, & (3) \\ F'_a = x + \lambda x_0 + 2\mu a = 0, & (4) \\ F'_b = y + \lambda y_0 + 2\mu b = 0, & (5) \\ F'_c = z + \lambda z_0 + 2\mu c = 0 & (6) \end{cases}$$

确定。

方程 (4)、(5)、(6) 要能解出 λ, μ ，其中 a, b, c 必须满足关系式

$$\begin{vmatrix} x & x_0 & a \\ y & y_0 & b \\ z & z_0 & c \end{vmatrix} = 0, \quad (7)$$

$$\text{记 } r_1 = \begin{vmatrix} y & y_0 \\ z & z_0 \end{vmatrix}, \quad r_2 = \begin{vmatrix} z & z_0 \\ x & x_0 \end{vmatrix}, \quad r_3 = \begin{vmatrix} x & x_0 \\ y & y_0 \end{vmatrix},$$

$$\text{则上述关系式可记为 } ar_1 + br_2 + cr_3 = 0. \quad (8)$$

由 (1)、(3)、(8) 可解得

$$a = \frac{\begin{vmatrix} 0 & y & z \\ \pm R & y_0 & z_0 \\ 0 & r_2 & r_3 \\ x & y & z \\ x_0 & y_0 & z_0 \\ r_1 & r_2 & r_3 \end{vmatrix}}{(r_1^2 + r_2^2 + r_3^2)} = \frac{\pm R(zr_2 - yr_3)}{(r_1^2 + r_2^2 + r_3^2)}$$

或

$$a^2 = \frac{R^2(zr_2 - yr_3)^2}{(r_1^2 + r_2^2 + r_3^2)^2},$$

$$b^2 = \frac{R^2(xr_3 - zr_1)^2}{(r_1^2 + r_2^2 + r_3^2)^2}, \quad c^2 = \frac{R^2(xr_2 - yr_1)^2}{(r_1^2 + r_2^2 + r_3^2)^2}. \quad (9)$$

将(9)式代入(2)式, 即得

$$\begin{aligned} (r_1^2 + r_2^2 + r_3^2)^2 &= R^2[(yr_3 - zr_2)^2 \\ &+ (xr_3 - zr_1)^2 + (xr_2 - yr_1)^2] \\ &= R^2[(r_1^2 + r_2^2 + r_3^2)(x^2 + y^2 + z^2) \\ &- (xr_1 + yr_2 + zr_3)^2] \\ &= R^2(r_1^2 + r_2^2 + r_3^2)(x^2 + y^2 + z^2). \end{aligned}$$

[其中利用了 $xr_1 + yr_2 + zr_3 = 0$, 这是不难验证的.]

于是, 有

$$r_1^2 + r_2^2 + r_3^2 = R^2(x^2 + y^2 + z^2). \quad (10)$$

由于原平面族无奇点, 且曲面(10)不是平面族的某一个, 因此, 曲面(10)即为包面. 所求的阴影圆锥为此锥面的内部, 即满足不等式

$$r_1^2 + r_2^2 + r_3^2 \leq R^2(x^2 + y^2 + z^2)$$

的空间区域 (严格说来, 还要除去球前部的区域).

解法二

显然，阴影圆锥是由通过坐标原点的球面 $(x-x_0)^2 + (y-y_0)^2 + (z-z_0)^2 = R^2$ 的全体切线构成的。由解析几何知，如果点 $P_1(x_1, y_1, z_1)$ 不在二次曲面

$$\begin{aligned} F(x, y, z) &= ax^2 + by^2 + cz^2 + 2fyz \\ &\quad + 2gxz + 2hxy + 2px + 2qy + 2rz + d \\ &= \varphi(x, y, z) + 2px + 2qy + 2rz + d = 0 \end{aligned} \quad (1)$$

上，则通过点 P_1 而和二次曲面(1)相切的全体切线所构成的锥面方程为

$$\begin{aligned} &[(x-x_1)F'_x(x_1, y_1, z_1) + (y-y_1) \\ &\quad \cdot F'_y(x_1, y_1, z_1) + (z-z_1)F'_z(x_1, y_1, z_1)]^2 \\ &\quad - 4\varphi(x-x_1, y-y_1, z-z_1) \\ &\quad \cdot F(x_1, y_1, z_1) = 0. \end{aligned} \quad (2)$$

$$\begin{aligned} \text{今有 } F(x, y, z) &= (x-x_0)^2 + (y-y_0)^2 \\ &\quad + (z-z_0)^2 - R^2 \\ &= x^2 + y^2 + z^2 - 2(x_0x + y_0y + z_0z) \\ &\quad + (x_0^2 + y_0^2 + z_0^2 - R^2). \end{aligned}$$

由于

$$\begin{aligned} F'_x(0, 0, 0) &= -2x_0, \quad F'_y(0, 0, 0) = -2y_0, \\ F'_z(0, 0, 0) &= -2z_0, \end{aligned}$$

故由(2)即得阴影圆锥面的方程为

$$\begin{aligned} &(-2x_0x - 2y_0y - 2z_0z)^2 - 4(x^2 + y^2 + z^2) \\ &\quad \cdot (x_0^2 + y_0^2 + z_0^2 - R^2) = 0 \end{aligned}$$

或

$$(y_0^2 + z_0^2)x^2 + (x_0^2 + z_0^2)y^2 + (x_0^2 + y_0^2)z^2$$

$$-2x_0y_0xy - 2y_0z_0yz - 2z_0x_0zx \\ - R^2(x^2 + y^2 + z^2) = 0.$$

由于

$$(y_0^2 + z_0^2)x_0^2 + (x_0^2 + z_0^2)y_0^2 + (x_0^2 + y_0^2)z_0^2 \\ - 2x_0^2y_0^2 - 2y_0^2z_0^2 - 2z_0^2x_0^2 \\ - R^2(x_0^2 + y_0^2 + z_0^2) = -R^2(x_0^2 + y_0^2 + z_0^2) < 0,$$

故所求的阴影圆锥为此锥面的内部，即满足不等式

$$(y_0^2 + z_0^2)x^2 + (z_0^2 + x_0^2)y^2 \\ + (x_0^2 + y_0^2)z^2 - 2x_0y_0xy - 2y_0z_0yz \\ - 2z_0x_0zx - R^2(x^2 + y^2 + z^2) \leq 0$$

或

$$\begin{vmatrix} x & y \\ x_0 & y_0 \end{vmatrix}^2 + \begin{vmatrix} y & z \\ y_0 & z_0 \end{vmatrix}^2 + \begin{vmatrix} z & x \\ z_0 & x_0 \end{vmatrix}^2 \\ \leq R^2(x^2 + y^2 + z^2)$$

的空间区域（严格说来，还要除去球前部的区域）。

解法三

如图 6.33 所示，由三角形的面积公式

$$\frac{1}{2} |\vec{r}| \cdot |\vec{l}_0| \sin \alpha$$



图 6.33

得到

$$|\vec{r} \times \vec{l}_0| = |\vec{r}| \cdot |\vec{l}_0| \cdot \frac{R}{|\vec{l}_0|},$$

其中 $\vec{l}_0 = \{x_0, y_0, z_0\}$, $\vec{r} = \{x, y, z\}$, 而 $P(x, y, z)$ 为锥面上的任意一点. 平方之, 即得圆锥曲面的方程为

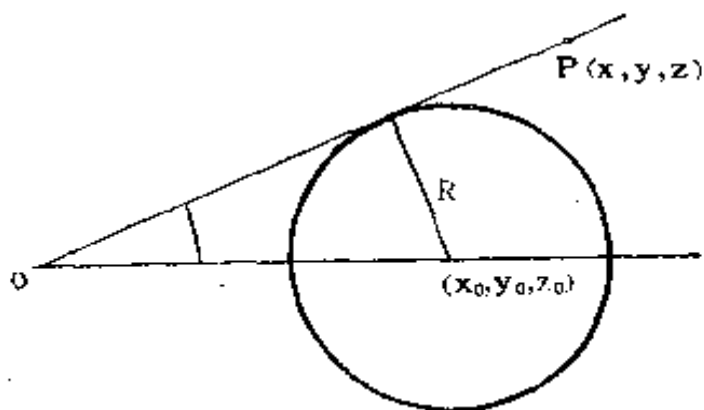
$$|\vec{r} \times \vec{l}_0|^2 = R^2 |\vec{r}|^2.$$

于是, 所求的阴影圆锥为适合不等式

$$|\vec{r} \times \vec{l}_0|^2 \leq R^2 |\vec{r}|^2,$$

即

$$\begin{aligned} & \left| \begin{array}{cc} x & y \\ x_0 & y_0 \end{array} \right|^2 + \left| \begin{array}{cc} y & z \\ y_0 & z_0 \end{array} \right|^2 + \left| \begin{array}{cc} z & x \\ z_0 & x_0 \end{array} \right|^2 \\ & \leq R^2 (x^2 + y^2 + z^2) \end{aligned}$$

的空间区域 (严格说来, 还要除去球前部的区域) .

3580. 若参变量 p 和 q 受方程

$$p^2 + q^2 = 1$$

的限制, 求平面族

$$z - z_0 = p(x - x_0) + q(y - y_0)$$

的包面.

解 解法一

引进辅助函数

$$\begin{aligned} F(x, y, z, p, q) &= z - z_0 - p(x - x_0) \\ &\quad - q(y - y_0) + \lambda(p^2 + q^2), \end{aligned}$$

则包面方程由方程组

$$\begin{cases} z - z_0 = p(x - x_0) + q(y - y_0), & (1) \\ p^2 + q^2 = 1, & (2) \\ F'_x = -(x - x_0) + 2\lambda p = 0, & (3) \\ F'_y = -(y - y_0) + 2\lambda q = 0 & (4) \end{cases}$$

确定.

(3) $\times p$ + (4) $\times q$, 得 $2\lambda = z - z_0$. 于是, 由(3), (4)得

$$p = \frac{x - x_0}{z - z_0}, \quad q = \frac{y - y_0}{z - z_0}. \quad (5)$$

将(5)式代入(1)式, 得

$$(z - z_0)^2 = (x - x_0)^2 + (y - y_0)^2.$$

由于原平面族无奇点, 且显见上述曲面不是平面, 故上述曲面即为包面.

解法二

引入新参数 θ ; 令 $p = \sin\theta$, $q = \cos\theta$.

$$\begin{cases} z - z_0 = \cos\theta \cdot (x - x_0) + \sin\theta \cdot (y - y_0), & (1) \\ \sin\theta \cdot (x - x_0) = \cos\theta \cdot (y - y_0). & (2) \end{cases}$$

于是,

$$\begin{aligned} \sin\theta &= \frac{\pm(y - y_0)}{\sqrt{(x - x_0)^2 + (y - y_0)^2}}, \\ \cos\theta &= \frac{\pm(x - x_0)}{\sqrt{(x - x_0)^2 + (y - y_0)^2}}. \end{aligned}$$

代入(1)式, 得

$$(z - z_0)^2 = (x - x_0)^2 + (y - y_0)^2.$$

由于原平面族无奇点, 且上述曲面不是平面, 故上述曲面即为包面.

§6. 台劳公式

1° 台劳公式 若函数 $f(x, y)$ 在点 (a, b) 的某邻域内有直到 $n+1$ 阶 (连 $n+1$ 阶的在内) 的一切连续偏导函数, 则在此邻域内下面的公式成立

$$f(x, y) = f(a, b) + \sum_{i=1}^n \frac{1}{i!} \left[(x-a) \frac{\partial}{\partial x} + (y-b) \frac{\partial}{\partial y} \right]^i f(a, b) + R_n(x, y), \quad (1)$$

其中

$$R_n(x, y) = \frac{1}{(n+1)!} \left[(x-a) \frac{\partial}{\partial x} + (y-b) \frac{\partial}{\partial y} \right]^{n+1} f \left[a + \theta_n(x-a), b + \theta_n(y-b) \right] \quad (0 \leq \theta_n \leq 1).$$

2° 台劳级数 若函数 $f(x, y)$ 可以无穷次地微分及 $\lim_{n \rightarrow \infty} R_n(x, y) = 0$, 则此函数可表成幂级数的形状

$$f(x, y) = f(a, b) + \sum_{i+j \geq 1}^{\infty} \frac{1}{i!j!} f_{x^i y^j}^{(i+j)}(a, b) (x-a)^i (y-b)^j. \quad (2)$$

特别情形, 当 $a=b=0$ 时公式(1)和(2)分别名为马克老林公式和马克老林级数.

对于多于两个变量的函数有类似的公式.

3° 平面曲线的奇点 设在某点 $M_0(x_0, y_0)$ 可微分两次的曲线 $F(x, y) = 0$ 适合下列条件

$$F(x_0, y_0) = 0, F'_x(x_0, y_0) = 0, F'_y(x_0, y_0) = 0$$

及数

$$A = F''_{xx}(x_0, y_0), B = F''_{xy}(x_0, y_0), C = F''_{yy}(x_0, y_0)$$

不全为零. 于是, 若

- (1) $AC - B^2 > 0$, 则 M_0 —孤立点;
- (2) $AC - B^2 < 0$, 则 M_0 —二重点(节);
- (3) $AC - B^2 = 0$, 则 M_0 —上升点或孤立点.

在 $A = B = C = 0$ 的情形, 奇点的种类可能更复杂. 至于不属于光滑的曲线类 $C^{(2)}$ 的曲线, 奇点还可能有更复杂的类型: 中断的点, 角点等等.

3581. 在点 $A(1, -2)$ 的邻域内根据台劳公式展开函数

$$f(x, y) = 2x^2 - xy - y^2 - 6x - 3y + 5.$$

解 $\frac{\partial f}{\partial x} = 4x - y - 6, \frac{\partial f}{\partial y} = -x - 2y - 3;$

$$\frac{\partial^2 f}{\partial x^2} = 4, \frac{\partial^2 f}{\partial x \partial y} = -1, \frac{\partial^2 f}{\partial y^2} = -2.$$

所有三阶偏导函数均为零, 因此, 有 $R_2(x, y) = 0$. 在点 $A(1, -2)$ 处,

$$f(1, -2) = 5, \frac{\partial f}{\partial x} = 0, \frac{\partial f}{\partial y} = 0,$$

$$\frac{\partial^2 f}{\partial x^2} = 4, \frac{\partial^2 f}{\partial x \partial y} = -1, \frac{\partial^2 f}{\partial y^2} = -2.$$

于是,

$$f(x, y) = 5 + 2(x-1)^2 - (x-1) \cdot (y+2) - (y+2)^2.$$

3582. 在点 $A(1, 1, 1)$ 的邻域内根据台劳公式展开函数

$$f(x, y, z) = x^3 + y^3 + z^3 - 3xyz.$$

解 $\frac{\partial f}{\partial x} = 3x^2 - 3yz, \frac{\partial f}{\partial y} = 3y^2 - 3xz,$

$$\frac{\partial f}{\partial z} = 3z^2 - 3xy;$$

$$\frac{\partial^2 f}{\partial x^2} = 6x, \frac{\partial^2 f}{\partial y^2} = 6y, \frac{\partial^2 f}{\partial z^2} = 6z,$$

$$\frac{\partial^2 f}{\partial x \partial y} = -3z, \frac{\partial^2 f}{\partial y \partial z} = -3x,$$

$$\frac{\partial^2 f}{\partial x \partial z} = -3y;$$

$$\frac{\partial^3 f}{\partial x^3} = \frac{\partial^3 f}{\partial y^3} = \frac{\partial^3 f}{\partial z^3} = 6, \frac{\partial^3 f}{\partial x \partial y \partial z} = -3, \text{ 其余}$$

的三阶混合偏导函数均为零;

所有的四阶偏导函数均为零, 因此, $R_4(x, y, z) = 0$. 在点 $A(1, 1, 1)$ 处,

$$f(1, 1, 1) = 0, \frac{\partial f}{\partial x} = \frac{\partial f}{\partial y} = \frac{\partial f}{\partial z} = 6, \frac{\partial^2 f}{\partial x \partial y} \\ = \frac{\partial^2 f}{\partial y \partial z} = \frac{\partial^2 f}{\partial x \partial z} = -3, \frac{\partial^3 f}{\partial x^3} = \frac{\partial^3 f}{\partial y^3} = \frac{\partial^3 f}{\partial z^3} = 6,$$

$\frac{\partial^3 f}{\partial x \partial y \partial z} = -3$, $\frac{\partial^3 f}{\partial x^2 \partial y} = \dots = \frac{\partial^3 f}{\partial z^2 \partial x} = 0$. 于是,

$$\begin{aligned} f(x, y, z) &= f(1, 1, 1) + \sum_{i=1}^3 \frac{1}{i!} \left[(x-1) \frac{\partial}{\partial x} \right. \\ &\quad \left. + (y-1) \frac{\partial}{\partial y} + (z-1) \frac{\partial}{\partial z} \right]^i f(1, 1, 1) \\ &= 3 \{ (x-1)^2 + (y-1)^2 + (z-1)^2 \\ &\quad - (x-1)(y-1) - (x-1)(z-1) \\ &\quad - (y-1)(z-1) \} + (x-1)^3 + (y-1)^3 \\ &\quad + (z-1)^3 - 3(x-1)(y-1)(z-1). \end{aligned}$$

3583. 当从 $x=1, y=-1$ 变到 $x_1=1+h, y_1=-1+k$ 时, 求函数 $f(x, y) = x^2 y + x y^2 - 2xy$ 的增量.

解 记 $A(1, -1)$ 及 $P(1+h, -1+k)$, 则

$$\left. \frac{\partial f}{\partial x} \right|_A = (2xy + y^2 - 2y) \Big|_A = 1,$$

$$\left. \frac{\partial f}{\partial y} \right|_A = (x^2 + 2xy - 2x) \Big|_A = -3;$$

$$\left. \frac{\partial^2 f}{\partial x^2} \right|_A = 2y \Big|_A = -2, \quad \left. \frac{\partial^2 f}{\partial y^2} \right|_A = 2x \Big|_A = 2,$$

$$\left. \frac{\partial^2 f}{\partial x \partial y} \right|_A = (2x + 2y - 2) \Big|_A = -2;$$

$$\left. \frac{\partial^3 f}{\partial x^3} \right|_A = \left. \frac{\partial^3 f}{\partial y^3} \right|_A = 0, \quad \left. \frac{\partial^3 f}{\partial x^2 \partial y} \right|_A = \left. \frac{\partial^3 f}{\partial x \partial y^2} \right|_A = 2;$$

所有四阶偏导函数均为零, 因此, $R_3(x, y) = 0$. 于是, 按台劳公式即得

$$\begin{aligned} \Delta f &= f(P) - f(A) = \sum_{i=1}^3 \left(h \frac{\partial}{\partial x} + k \frac{\partial}{\partial y} \right)^i f(A) \\ &= (h - 3k) + (-h^2 - 2hk + k^2) + hk(h + k). \end{aligned}$$

3584. 设:

$$\begin{aligned} f(x, y, z) &= Ax^2 + By^2 + Cz^2 \\ &\quad + 2Dxy + 2Exz + 2Fyz, \end{aligned}$$

按数 h, k 和 l 的正整数幂展开 $f(x+h, y+k, z+l)$.

$$\text{解} \quad \frac{\partial f}{\partial x} = 2(Ax + Dy + Ez), \quad \frac{\partial^2 f}{\partial x^2} = 2A, \quad \frac{\partial^2 f}{\partial x \partial y} = 2D,$$

$$\frac{\partial f}{\partial y} = 2(By + Dx + Fz), \quad \frac{\partial^2 f}{\partial y^2} = 2B,$$

$$\frac{\partial^2 f}{\partial y \partial z} = 2F,$$

$$\frac{\partial f}{\partial z} = 2(Cz + Ex + Fy), \quad \frac{\partial^2 f}{\partial z^2} = 2C, \quad \frac{\partial^2 f}{\partial z \partial x} = 2E.$$

所有三阶偏导函数均为零, 因此, $R_2(x, y) = 0$.
于是, 按台劳公式即得

$$\begin{aligned} f(x+h, y+k, z+l) &= f(x, y, z) \\ &\quad + \sum_{i=1}^2 \left(h \frac{\partial}{\partial x} + k \frac{\partial}{\partial y} + l \frac{\partial}{\partial z} \right)^i f(x, y, z) \\ &= f(x, y, z) + 2[h(Ax + Dy + Ez) \\ &\quad + k(By + Dx + Fz) + l(Cz + Ex + Fy)] \\ &\quad + [Ah^2 + Bk^2 + Cl^2 + 2Dhk + 2Ehl + 2Fkl] \\ &= f(x, y, z) + 2[h(Ax + Dy + Ez) + k(Dx \end{aligned}$$

$$+By + Fz) + l(Ex + Fy + Cz)] + f(h, k, l).$$

3585. 写出函数

$$f(x, y) = x^y$$

在点 $A(1, 1)$ 的邻域内的展开式, 到二次项为止.

解 $\frac{\partial f}{\partial x} = yx^{y-1}, \frac{\partial f}{\partial y} = x^y \ln x,$

$$\frac{\partial^2 f}{\partial x^2} = y(y-1)x^{y-2}, \frac{\partial^2 f}{\partial x \partial y} = x^{y-1} + yx^{y-1} \ln x,$$

$$\frac{\partial^2 f}{\partial y^2} = x^y \ln^2 x, \frac{\partial^3 f}{\partial x^3} = y(y-1)(y-2)x^{y-3},$$

$$\frac{\partial^3 f}{\partial y^3} = x^y \ln^3 x,$$

$$\frac{\partial^3 f}{\partial x^2 \partial y} = (2y-1)x^{y-2} + y(y-1)x^{y-2} \ln x,$$

$$\frac{\partial^3 f}{\partial x \partial y^2} = yx^{y-1} \ln^2 x + 2x^{y-1} \ln x.$$

于是, 按台劳公式在点 $(1, 1)$ 附近展到二次项, 得

$$x^y = 1 + (x-1) + (x-1)(y-1) + R_2 [1 + \theta(x-1), 1 + \theta(y-1)], \quad 0 < \theta < 1, \quad \text{其中余项}$$

$$\begin{aligned} R_2(x, y) &= \frac{1}{3!} \{ y(y-1)(y-2)x^{y-3} dx^3 \\ &\quad + 3[(2y-1)x^{y-2} + y(y-1)x^{y-2} \ln x] dx^2 dy \\ &\quad + 3[yx^{y-1} \ln^2 x + 2x^{y-1} \ln x] dx dy^2 + x^y \ln^3 x dy^3 \} \\ &= \frac{1}{6} x^y \left[\left(\frac{y}{x} dx + \ln x dy \right)^3 + 3 \left(\frac{y}{x} dx + \ln x dy \right) \right] \end{aligned}$$

$$\left. \left(-\frac{y}{x^2} dx^2 + \frac{2}{x} dx dy \right) + \left(\frac{2y}{x^3} dx^3 - \frac{3}{x^2} dx^2 dy \right) \right\},$$

$$dx = x - 1, \quad dy = y - 1.$$

3586. 根据马克老林公式展开函数

$$f(x, y) = \sqrt{1 - x^2 - y^2}$$

到四次项为止.

解 由于

$$(1+x)^{\frac{1}{2}} = 1 + \frac{1}{2}x + \frac{\left(\frac{1}{2}\right)\left(\frac{1}{2}-1\right)}{2!}x^2$$

$$+ \frac{\left(\frac{1}{2}\right)\left(\frac{1}{2}-1\right)\left(\frac{1}{2}-2\right)}{3!}x^3 + \dots$$

$$\approx 1 + \frac{1}{2}x - \frac{1}{8}x^2 + \frac{1}{16}x^3,$$

故得

$$f(x, y) = \sqrt{1 - x^2 - y^2} = [1 + (-x^2 - y^2)]^{\frac{1}{2}}$$

$$\approx 1 - \frac{1}{2}(x^2 + y^2) - \frac{1}{8}(x^2 + y^2)^2.$$

3587. 若 $|x|$ 和 $|y|$ 同 1 比较为很小的量, 对于下列二式

$$(a) \frac{\cos x}{\cos y}; \quad (b) \operatorname{arctg} \frac{1+x+y}{1-x+y}$$

推出准确到二次项的近似公式.

$$\text{解 } (a) \frac{\cos x}{\cos y} = \cos x \cdot (1 - \sin^2 y)^{-\frac{1}{2}}$$

$$= \left(1 - \frac{x^2}{2} + \dots\right) \cdot \left(1 + \frac{1}{2}\sin^2 y + \dots\right)$$

$$\approx \left(1 - \frac{x^2}{2}\right) \left(1 + \frac{1}{2}\sin^2 y\right)$$

$$\approx \left(1 - \frac{x^2}{2}\right) \left(1 + \frac{1}{2}y^2\right) \approx 1 - \frac{1}{2}(x^2 - y^2).$$

$$(6) \operatorname{arc} \operatorname{tg} \frac{1+x+y}{1-x+y} = \operatorname{arc} \operatorname{tg} \frac{1 + \frac{x}{1+y}}{1 - \frac{x}{1+y}}$$

$$= \frac{\pi}{4} + \operatorname{arc} \operatorname{tg} \frac{x}{1+y}$$

$$= \frac{\pi}{4} + \left(\frac{x}{1+y}\right) - \frac{1}{3}\left(\frac{x}{1+y}\right)^3 + \dots$$

$$\approx \frac{\pi}{4} + x(1-y+y^2) \approx \frac{\pi}{4} + x - xy.$$

3588. 假定 x, y, z 的绝对值是很小的量, 简化下式

$$\cos(x+y+z) - \cos x \cos y \cos z.$$

解 我们简化上式到二次项.

$$\cos(x+y+z) - \cos x \cos y \cos z$$

$$\approx 1 - \frac{1}{2}(x+y+z)^2 - \left(1 - \frac{1}{2}x^2\right)$$

$$\cdot \left(1 - \frac{1}{2}y^2\right) \left(1 - \frac{1}{2}z^2\right).$$

$$\approx 1 - \frac{1}{2}(x^2 + y^2 + z^2) - (xy + yz + zx)$$

$$\begin{aligned}
 & -\left(1 - \frac{1}{2}x^2 - \frac{1}{2}y^2 - \frac{1}{2}z^2\right) \\
 & = -(xy + yz + zx).
 \end{aligned}$$

3589. 依 h 的乘幂把函数

$$F(x, y) = \frac{1}{4} [f(x+h, y) + f(x, y+h)$$

$$+ f(x-h, y) + f(x, y-h)] - f(x, y)$$

展开, 准确到 h^4 .

解 记 $\frac{\partial f(x, y)}{\partial x} = \frac{\partial f}{\partial x}$ 及 $\frac{\partial f(x, y)}{\partial y} = \frac{\partial f}{\partial y}$, ... 余类似,

即得

$$\begin{aligned}
 F(x, y) &= \frac{1}{4} \{ [f(x+h, y) - f(x, y)] \\
 &+ [f(x, y+h) - f(x, y)] \\
 &+ [f(x-h, y) - f(x, y)] + [f(x, y-h) \\
 &- f(x, y)] \} \\
 &\approx \frac{1}{4} \left\{ \left[h \frac{\partial f}{\partial x} + \frac{1}{2} h^2 \frac{\partial^2 f}{\partial x^2} + \frac{1}{6} h^3 \frac{\partial^3 f}{\partial x^3} + \frac{1}{24} h^4 \frac{\partial^4 f}{\partial x^4} \right] \right. \\
 &+ \left[h \frac{\partial f}{\partial y} + \frac{1}{2} h^2 \frac{\partial^2 f}{\partial y^2} + \frac{1}{6} h^3 \frac{\partial^3 f}{\partial y^3} + \frac{1}{24} h^4 \frac{\partial^4 f}{\partial y^4} \right] \\
 &+ \left[-h \frac{\partial f}{\partial x} + \frac{1}{2} h^2 \frac{\partial^2 f}{\partial x^2} - \frac{1}{6} h^3 \frac{\partial^3 f}{\partial x^3} + \frac{1}{24} h^4 \frac{\partial^4 f}{\partial x^4} \right]
 \end{aligned}$$

$$\begin{aligned}
& + \left\{ -h \frac{\partial f}{\partial y} + \frac{1}{2} h^2 \frac{\partial^2 f}{\partial y^2} - \frac{1}{6} h^3 \frac{\partial^3 f}{\partial y^3} \right. \\
& \left. + \frac{1}{24} h^4 \frac{\partial^4 f}{\partial y^4} \right\} \\
& = \frac{h^2}{4} \left(\frac{\partial^2 f}{\partial x^2} + \frac{\partial^2 f}{\partial y^2} \right) + \frac{h^4}{48} \left(\frac{\partial^4 f}{\partial x^4} + \frac{\partial^4 f}{\partial y^4} \right).
\end{aligned}$$

3590. 已知中心在点 $P(x, y)$ 半径为 ρ 的圆周, 设 $f(P) = f(x, y)$ 及 $P_i(x_i, y_i)$ ($i=1, 2, 3$) 为已知圆周之内接正三角形的顶点, 并且 $x_1 = x + \rho, y_1 = y$. 依 ρ 的正整数幂把函数

$$F(\rho) = \frac{1}{3} [f(P_1) + f(P_2) + f(P_3)]$$

展开准确到 ρ^2 .

解 如图 6.34 所示.

$\triangle P_1 P_2 P_3$ 之三顶点分别为

$$P_1(x + \rho, y),$$

$$P_2\left(x - \frac{\rho}{2}, y\right.$$

$$\left. + \frac{\sqrt{3}}{2}\rho\right),$$

$$P_3\left(x - \frac{\rho}{2}, y - \frac{\sqrt{3}}{2}\rho\right).$$

于是,



图 6.34

$$\begin{aligned}
F(\rho) &= \frac{1}{3} [f(P_1) + f(P_2) + f(P_3)] \\
&\approx \frac{1}{3} \left\{ \left[f(P) + \rho \frac{\partial f}{\partial x} + \frac{\rho^2}{2} \frac{\partial^2 f}{\partial x^2} \right] + \left[f(P) \right. \right. \\
&\quad \left. \left. + \left(-\frac{\rho}{2}\right) \frac{\partial f}{\partial x} + \frac{\sqrt{3}}{2} \rho \frac{\partial f}{\partial y} + \frac{\rho^2}{8} \frac{\partial^2 f}{\partial x^2} \right. \right. \\
&\quad \left. \left. + \frac{3\rho^2}{8} \frac{\partial^2 f}{\partial y^2} - \frac{\sqrt{3}\rho^2}{4} \frac{\partial^2 f}{\partial x \partial y} \right] \right. \\
&\quad \left. + \left[f(P) + \left(-\frac{\rho}{2}\right) \frac{\partial f}{\partial x} + \left(-\frac{\sqrt{3}}{2}\right) \rho \frac{\partial f}{\partial y} + \frac{\rho^2}{8} \frac{\partial^2 f}{\partial x^2} \right. \right. \\
&\quad \left. \left. + \frac{3\rho^2}{8} \frac{\partial^2 f}{\partial y^2} + \frac{\sqrt{3}\rho^2}{4} \frac{\partial^2 f}{\partial x \partial y} \right] \right\} \\
&= f(P) + \frac{\rho^2}{4} \left(\frac{\partial^2 f}{\partial x^2} + \frac{\partial^2 f}{\partial y^2} \right).
\end{aligned}$$

3591. 依 h 与 k 的乘幂把函数

$$\begin{aligned}
\Delta_{xy} f(x, y) &= f(x+h, y+k) - f(x+h, y) \\
&\quad - f(x, y+k) + f(x, y)
\end{aligned}$$

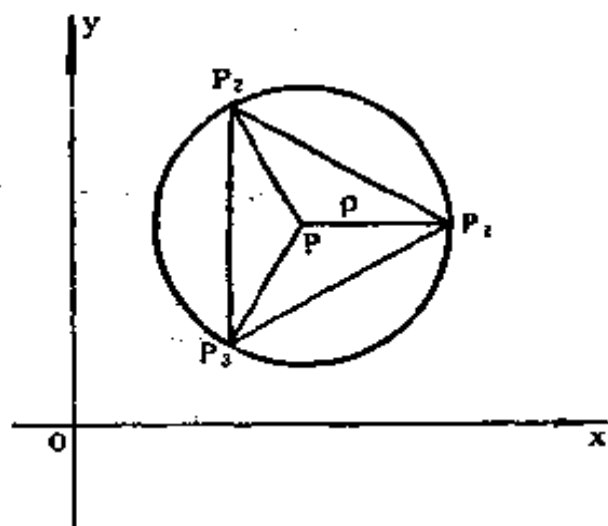
展开.

$$\begin{aligned}
\text{解} \quad \Delta_{xy} f(x, y) &= \left[f(x, y) + h \frac{\partial f}{\partial x} + k \frac{\partial f}{\partial y} + \sum_{n=2}^{\infty} \sum_{m=0}^n \frac{h^n k^{n-m}}{m!(n-m)!} \frac{\partial^n f}{\partial x^m \partial y^{n-m}} \right] \\
&\quad - \left[f(x, y) + \sum_{n=1}^{\infty} \frac{h^n}{n!} \frac{\partial^n f}{\partial x^n} \right] \\
&\quad - \left[f(x, y) + \sum_{n=1}^{\infty} \frac{k^n}{n!} \frac{\partial^n f}{\partial y^n} \right] + f(x, y)
\end{aligned}$$

$$\begin{aligned}
&= \sum_{n=2}^{\infty} \sum_{m=1}^{n-1} \frac{h^m k^{n-m}}{m!(n-m)!} \frac{\partial^n f}{\partial x^m \partial y^{n-m}} \\
&= hk \left[\frac{\partial^2 f}{\partial x \partial y} + \sum_{n=3}^{\infty} \sum_{m=1}^{n-1} \frac{h^{m-1} k^{n-m-1}}{m!(n-m)!} \frac{\partial^n f}{\partial x^m \partial y^{n-m}} \right].
\end{aligned}$$

3592. 依 ρ 的乘幂把函数

$$F(\rho) = \frac{1}{2\pi} \int_0^{2\pi} f(x + \rho \cos \varphi, y + \rho \sin \varphi) d\varphi$$

展开.

$$\begin{aligned}
\text{解 } F(\rho) &= \frac{1}{2\pi} \int_0^{2\pi} \left[f(x, y) + \sum_{n=1}^{\infty} \sum_{m=0}^n \frac{\rho^n \cos^m \varphi \sin^{n-m} \varphi}{m!(n-m)!} \right. \\
&\quad \left. \cdot \frac{\partial^n f(x, y)}{\partial x^m \partial y^{n-m}} \right] d\varphi \\
&= f(x, y) + \sum_{n=1}^{\infty} \sum_{m=0}^n \frac{\rho^n}{m!(n-m)!} \frac{\partial^n f(x, y)}{\partial x^m \partial y^{n-m}} \\
&\quad \cdot \frac{1}{2\pi} \int_0^{2\pi} \cos^m \varphi \sin^{n-m} \varphi d\varphi.
\end{aligned}$$

下面计算上式中的积分.

$$\begin{aligned}
\frac{1}{2\pi} \int_0^{2\pi} \cos^m \varphi \sin^{n-m} \varphi d\varphi &= \frac{1}{2\pi} \int_0^{\frac{\pi}{2}} \cos^m \varphi \sin^{n-m} \varphi d\varphi \\
&+ \frac{1}{2\pi} \int_0^{\frac{\pi}{2}} \cos^m(\pi - \varphi) \sin^{n-m}(\pi - \varphi) d\varphi \\
&+ \frac{1}{2\pi} \int_0^{\frac{\pi}{2}} \cos^m(\pi + \varphi) \sin^{n-m}(\pi + \varphi) d\varphi
\end{aligned}$$

$$\begin{aligned}
& + \frac{1}{2\pi} \int_0^{\frac{\pi}{2}} \cos^m(2\pi - \varphi) \sin^{n-m}(2\pi - \varphi) d\varphi \\
& = \frac{1}{2\pi} [1 + (-1)^n + (-1)^n + (-1)^{n-n}] \\
& \quad \cdot \int_0^{\frac{\pi}{2}} \cos^n \varphi \sin^{n-m} \varphi d\varphi.
\end{aligned}$$

当 m, n 中至少有一个为奇数时, 显见上述积分为零。
 当 m, n 均为偶数时, 由 2290 题的结果知:

$$\begin{aligned}
\frac{1}{2\pi} \int_0^{2\pi} \cos^{2m} \varphi \sin^{2n-2m} \varphi d\varphi & = \frac{4}{2\pi} \int_0^{\frac{\pi}{2}} \cos^{2m} \varphi \sin^{2n-2m} \varphi d\varphi \\
& = \frac{2}{\pi} \cdot \frac{\pi (2m)! (2n-2m)!}{2^{2n+1} m! n! (n-m)!} = \frac{(2m)! (2n-2m)!}{2^{2n} m! n! (n-m)!}.
\end{aligned}$$

代入原式, 并注意到其中的 m, n 只能为偶数, 适当改变一下指标的编号, 即得

$$\begin{aligned}
F(\rho) & = f(x, y) + \sum_{n=1}^{\infty} \sum_{m=0}^n \frac{\rho^{2n}}{(2m)! (2n-2m)!} \\
& \quad \cdot \frac{\partial^{2n} f(x, y)}{\partial x^{2m} \partial y^{2n-2m}} \cdot \frac{(2m)! (2n-2m)!}{2^{2n} m! n! (n-m)!} \\
& = f(x, y) \sum_{n=1}^{\infty} \frac{1}{(n!)^2} \left(\frac{\rho}{2}\right)^{2n} \\
& \quad \cdot \sum_{m=0}^n \frac{n!}{m! (n-m)!} \frac{\partial^{2n} f(x, y)}{\partial x^{2m} \partial y^{2n-2m}} \\
& = f(x, y) + \sum_{n=1}^{\infty} \frac{1}{(n!)^2} \left(\frac{\rho}{2}\right)^{2n} \left(\frac{\partial^2}{\partial x^2} + \frac{\partial^2}{\partial y^2}\right)^n f(x, y).
\end{aligned}$$

将下列函数展开成马克老林级数:

3593. $f(x, y) = (1+x)^m(1+y)^n$.

解 $f(x, y) = (1+x)^m(1+y)^n = \left[1 + mx + \frac{m(m-1)}{2!} \cdot x^2 + \dots\right] \left[1 + ny + \frac{n(n-1)}{2!} y^2 + \dots\right]$

$$= 1 + (mx + ny) + \frac{1}{2!} [m(m-1)x^2 + 2mnxy + n(n-1)y^2] + \dots$$

($|x| < 1, |y| < 1$).

3594. $f(x, y) = \ln(1+x+y)$.

解 $f(x, y) = \ln[1+(x+y)] = \sum_{k=1}^{\infty} \frac{(-1)^{k-1}}{k} (x+y)^k$

$$= \sum_{k=1}^{\infty} \left[\sum_{n=0}^k \frac{(-1)^{k-1}}{k} \frac{k!}{m!(k-m)!} x^m y^{k-m} \right]$$

$$= \sum_{k=1}^{\infty} \sum_{n=0}^k \frac{(-1)^{k-1} (k-1)!}{m!(k-m)!} x^m y^{k-m} \quad (1)$$

$$= \sum_{m=0}^{\infty} \sum_{n=0}^{\infty} \frac{(-1)^{m+n-1} (m+n-1)!}{m!n!} x^m y^n. \quad (2)$$

当 $m=0, n=0$ 时, 分子出现 $(-1)_1$, 规定该项为零. 下面讨论一下收敛区间. (1) 成立, 只要求 $|x+y| < 1$ 即可. 但从(1)式到(2)式, 必需要求(1)式绝对收敛, 这样才能将各项重新排列. 不难看出(1)式级数各项取绝对值后即函数 $-\ln[1-(|x|+|y|)]$ 的展开式, 它的收敛性要求 $|x|+|y| < 1$. 这就是 $f(x, y)$ 的展

开式的收敛区域.

3595. $f(x, y) = e^x \sin y.$

$$\begin{aligned} \text{解 } f(x, y) &= \left[\sum_{m=0}^{\infty} \frac{x^m}{m!} \right] \left[\sum_{n=0}^{\infty} (-1)^n \frac{y^{2n+1}}{(2n+1)!} \right] \\ &= \sum_{m=0}^{\infty} \sum_{n=0}^{\infty} (-1)^n \frac{x^m y^{2n+1}}{m! (2n+1)!} \\ &\quad (|x| < +\infty, |y| < +\infty). \end{aligned}$$

3596. $f(x, y) = e^x \cos y.$

$$\begin{aligned} \text{解 } f(x, y) &= \left[\sum_{m=0}^{\infty} \frac{x^m}{m!} \right] \left[\sum_{n=0}^{\infty} (-1)^n \frac{y^{2n}}{(2n)!} \right] \\ &= \sum_{m=0}^{\infty} \sum_{n=0}^{\infty} (-1)^n \frac{x^m y^{2n}}{m! (2n)!} \\ &\quad (|x| < +\infty, |y| < +\infty). \end{aligned}$$

3597. $f(x, y) = \sin x \operatorname{sh} y.$

$$\begin{aligned} \text{解 } \operatorname{sh} y &= \frac{e^y - e^{-y}}{2} = \frac{1}{2} \left[\sum_{n=0}^{\infty} \frac{y^n}{n!} - \sum_{n=0}^{\infty} (-1)^n \frac{y^n}{n!} \right] \\ &= \sum_{n=0}^{\infty} \frac{y^{2n+1}}{(2n+1)!} \quad (|y| < +\infty). \end{aligned}$$

于是,

$$\begin{aligned} f(x, y) &= \left[\sum_{m=0}^{\infty} (-1)^m \frac{x^{2m+1}}{(2m+1)!} \right] \\ &\quad \cdot \left[\sum_{n=0}^{\infty} \frac{y^{2n+1}}{(2n+1)!} \right] \end{aligned}$$

$$= \sum_{m=0}^{\infty} \sum_{n=0}^{\infty} (-1)^n \frac{x^{2m+1} y^{2n+1}}{(2m+1)!(2n+1)!}$$

$$(|x| < +\infty, |y| < +\infty).$$

3598. $f(x, y) = \cos x \operatorname{ch} y$.

解 $\operatorname{ch} y = \frac{e^y + e^{-y}}{2} = \sum_{n=0}^{\infty} \frac{y^{2n}}{(2n)!} \quad (|y| < +\infty).$

于是,

$$\begin{aligned} f(x, y) &= \left[\sum_{m=0}^{\infty} (-1)^m \frac{x^{2m}}{(2m)!} \right] \left[\sum_{n=0}^{\infty} \frac{y^{2n}}{(2n)!} \right] \\ &= \sum_{m=0}^{\infty} \sum_{n=0}^{\infty} (-1)^m \frac{x^{2m} y^{2n}}{(2m)!(2n)!} \end{aligned}$$

$$(|x| < +\infty, |y| < +\infty).$$

3599. $f(x, y) = \sin(x^2 + y^2)$.

解 $f(x, y) = \sum_{n=0}^{\infty} (-1)^n \frac{(x^2 + y^2)^{2n+1}}{(2n+1)!}$

$$= \sum_{n=0}^{\infty} \sum_{k=0}^{2n+1} (-1)^n \frac{x^{2k} y^{2(2n+1-k)}}{k!(2n+1-k)!}$$

$$= \sum_{m, n=0}^{\infty} \left(\sin \frac{n+m}{2} \pi \right) \frac{x^{2n} y^{2m}}{n!m!} \quad (x^2 + y^2 < +\infty).$$

3600. $f(x, y) = \ln(1+x) \ln(1+y)$.

解 $f(x, y) = \left[\sum_{m=1}^{\infty} (-1)^{m-1} \frac{x^m}{m} \right] \left[\sum_{n=1}^{\infty} (-1)^{n-1} \frac{y^n}{n} \right]$

$$= \sum_{m=1}^{\infty} \sum_{n=1}^{\infty} (-1)^{m+n} \frac{x^m y^n}{mn} \quad (|x| < 1, |y| < 1).$$

3601. 写出函数

$$f(x, y) = \int_0^1 (1+x)t^2 y dt$$

的马克劳林级数前面不为零的三项.

解 $(1+x)t^2 y = e^{t^2 y \ln(1+x)} \approx 1 + t^2 y \ln(1+x)$

$$+ \frac{1}{2!} [t^2 y \ln(1+x)]^2$$

$$\approx 1 + t^2 y \left(x - \frac{x^2}{2} \right) = 1 + t^2 x y - \frac{t^2}{2} x^2 y.$$

于是,

$$f(x, y) \approx \int_0^1 \left(1 + t^2 x y - \frac{t^2}{2} x^2 y \right) dt$$

$$= 1 + \frac{1}{3} y \left(x - \frac{x^2}{2} \right).$$

3602. 按二项式 $x-1$ 和 $y+1$ 的正整数幂将函数 e^{x+y} 展开成幂级数.

解 $e^{x+y} = e^{(x-1) + (y+1)} = e^{x-1} \cdot e^{y+1}$

$$= \sum_{n=0}^{\infty} \sum_{m=0}^{\infty} \frac{(x-1)^m (y+1)^n}{m! n!}$$

$$(|x| < +\infty, |y| < +\infty).$$

3603. 写出函数 $f(x, y) = \frac{x}{y}$ 在点 $M(1, 1)$ 的邻域内的台劳级数展开式.

解 令 $x = 1 + h$, $y = 1 + k$, 则得

$$\frac{x}{y} = \frac{1+h}{1+k} = (1+h) \sum_{n=0}^{\infty} (-1)^n k^n$$

$$= \sum_{n=0}^{\infty} (-1)^n [1 + (x-1)] (y-1)^n$$

$$(|x| < +\infty, 0 < y < 2).$$

3604. 设 z 为由方程 $z^3 - 2xz + y = 0$ 所定义的 x 和 y 的隐函数, 当 $x=1$ 和 $y=1$ 时它的值为 $z=1$.

写出函数 z 按二项式 $x-1$ 和 $y-1$ 的升幂排列的展开式中的若干项.

解 对原方程微分一次, 得

$$3z^2 dz - 2x dz - 2z dx + dy = 0. \quad (1)$$

再微分一次, 得

$$(3z^2 - 2x) d^2 z + 6z dz^2 - 4dx dz = 0. \quad (2)$$

以 $x=1, y=1, z=1$ 代入(1),(2)两式, 得

$$dz = 2dx - dy,$$

$$d^2 z = (4dx - 6dz) dz = (4dx - 12dx + 6dy)$$

$$\cdot (2dx - dy)$$

$$= -16dx^2 + 20dxdy - 6dy^2,$$

.....

于是, 可求得在 $x=1, y=1$ 处,

$$\frac{\partial z}{\partial x} = 2, \quad \frac{\partial z}{\partial y} = -1;$$

$$\frac{\partial^2 z}{\partial x^2} = -16, \quad \frac{\partial^2 z}{\partial x \partial y} = 10, \quad \frac{\partial^2 z}{\partial y^2} = -6;$$

.....

从而有

$$z = 1 + 2(x-1) - (y-1) - [8(x-1)^2$$

$$-10(x-1)(y-1)+3(y-1)^2]+ \dots$$

研究下列曲线的奇点的种类并大略地绘出这些曲线:

3605. $y^2 = ax^2 + x^3,$

解 解方程组

$$\begin{cases} F(x, y) = ax^2 + x^3 - y^2 = 0, \\ F'_x(x, y) = 2ax + 3x^2 = 0, \\ F'_y(x, y) = -2y = 0 \end{cases}$$

得 $x = 0, y = 0$, 故点 $(0, 0)$ 为奇点.

其次, 由于

$$A = F''_{xx}(0, 0) = 2a, B = F''_{xy}(0, 0) = 0,$$

$$C = F''_{yy}(0, 0) = -2, AC - B^2 = -4a,$$

故当 $a > 0$ 时, 点 $(0, 0)$ 为二重点; 当 $a < 0$ 时, 点 $(0, 0)$ 为孤立点; 当 $a = 0$ 时, 原方程化为 $y^2 = x^3$, 由 3574(6) 的讨论知点 $(0, 0)$ 为尖点.

如图 6.35 所示, 点 A_1 为 $(-a, 0)$.



图 6.35

3606. $x^3 + y^3 - 3xy = 0.$

解 解方程组

$$\begin{cases} F(x, y) = x^3 + y^3 - 3xy = 0, \\ F'_x(x, y) = 3x^2 - 3y = 0, \\ F'_y(x, y) = 3y^2 - 3x = 0 \end{cases}$$

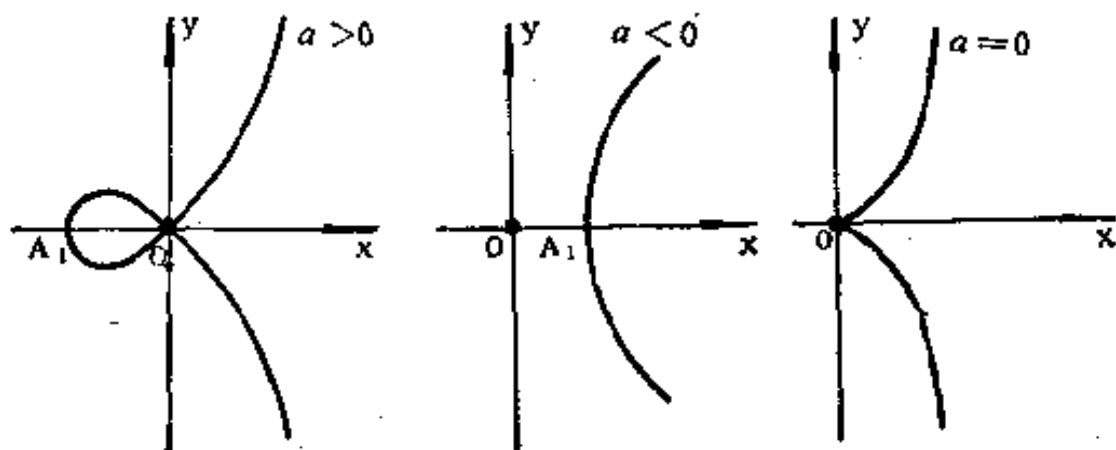
得 $x=0, y=0$, 故点 $(0,0)$ 为奇点.

又因 $A=F''_{xx}(0,0)=0, B=F''_{xy}(0,0)=-3, C=F''_{yy}(0,0)=0$, 且 $AC-B^2=-9<0$, 故点 $(0,0)$ 为二重点. 图象参看 370 题(6).

3607. $x^2 + y^2 = x^4 + y^4$.

解 解方程组

$$\begin{cases} F(x, y) = x^2 + y^2 - x^4 - y^4 = 0, \\ F'_x(x, y) = 2x - 4x^3 = 0, \\ F'_y(x, y) = 2y - 4y^3 = 0 \end{cases}$$

得 $x=0, y=0$, 故点 $(0,0)$ 为奇点.

又因 $A=F''_{xx}(0,0)=2, B=F''_{xy}(0,0)=0, C=F''_{yy}(0,0)=2$, 且 $AC-B^2=4>0$, 故点 $(0,0)$ 为孤立点. 图象参看 1542 题.

3608. $x^2 + y^4 = x^6$.

解 解方程组

$$\begin{cases} F(x, y) = x^2 + y^4 - x^6 = 0, \\ F'_x(x, y) = 2x - 6x^5 = 0, \\ F'_y(x, y) = 4y^3 = 0 \end{cases}$$

得 $x=0, y=0$, 故点 $(0,0)$ 为奇点.

又因 $A=F''_{xx}(0,0)=2, B=F''_{xy}(0,0)=0, C=F''_{yy}(0,0)=0$, 且 $AC-B^2=0$, 故点 $(0,0)$ 为上升点或孤立点. 本题中, 点 $(0,0)$ 为孤立点 (图 6·36). 事

实上, 将原方程改写为 $y^4 = x^6 - x^2$, 对 $(0, 0)$ 点的很小的邻域内的点 $(|x| < 1, |y| < 1)$, 左端 $y^4 \geq 0$, 右端 $x^6 - x^2 = x^2(x^4 - 1) \leq 0$, 除点 $(0, 0)$ 外没有适合方程的点, 故点 $(0, 0)$ 为孤立点.



图 6.36

3609. $(x^2 + y^2)^2 = a^2(x^2 - y^2)$.

解 解方程组

$$\begin{cases} F(x, y) = (x^2 + y^2)^2 - a^2(x^2 - y^2) = 0, \\ F'_x(x, y) = 4x(x^2 + y^2) - 2a^2x = 0, \\ F'_y(x, y) = 4y(x^2 + y^2) + 2a^2y = 0 \end{cases}$$

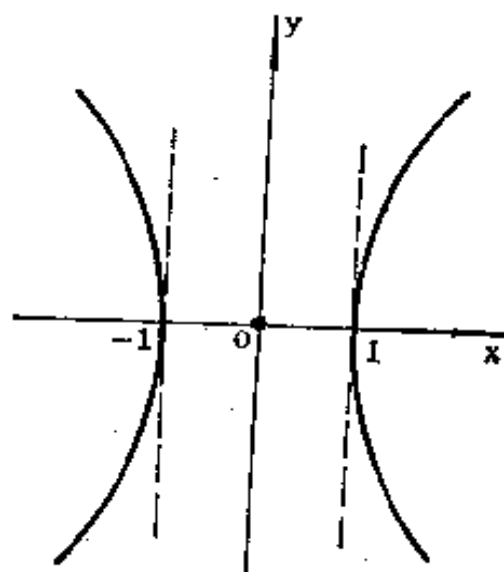
得 $x=0, y=0$, 故点 $(0, 0)$ 为奇点.

又因 $A = F''_{xx}(0, 0) = -2a^2, B = F''_{xy}(0, 0) = 0, C = F''_{yy}(0, 0) = 2a^2$, 且 $AC - B^2 = -4a^4 < 0 (a \neq 0)$, 故点 $(0, 0)$ 为二重点. 图象参看 3367 题, 只须将该题中的 1 换成 a .

3610. $(y - x^2)^2 = x^5$.

解 解方程组

$$\begin{cases} F(x, y) = (y - x^2)^2 - x^5 = 0, \\ F'_x(x, y) = -4x(y - x^2) - 5x^4 = 0, \\ F'_y(x, y) = 2(y - x^2) = 0 \end{cases}$$

得 $x=0, y=0$, 故点 $(0, 0)$ 为奇点.

又因 $A = F''_{xx}(0, 0) = 0$, $B = F''_{xy}(0, 0) = 0$, $C = F''_{yy}(0, 0) = 2$, 且 $AC - B^2 = 0$, 故对点 $(0, 0)$ 还需要再讨论一下. 由原方程可解出 $y = x^2 \pm x^{\frac{5}{2}}$, 右边只允许 $x \geq 0$, 当 $0 < x < 1$ 时不论取“+”号还是“-”号均有 $y > 0$, 且均有

$$\lim_{x \rightarrow +0} \frac{dy}{dx} = 0,$$

故点 $(0, 0)$ 为尖点, 如图 6.37 所示.

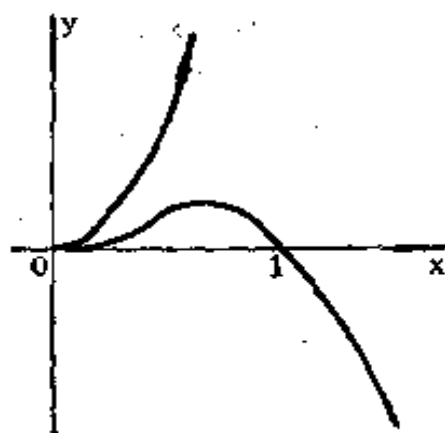

3611. $(a+x)y^2 = (a-x)x^2$.

图 6.37

解 解方程组

$$\begin{cases} F(x, y) = (a+x)y^2 - (a-x)x^2 = 0, & (1) \\ F'_x(x, y) = y^2 - 2ax + 3ax^2 = 0, & (2) \\ F'_y(x, y) = 2(a+x)y = 0. & (3) \end{cases}$$

由(3)得 $x = -a$ 或 $y = 0$.

将 $y = 0$ 代入(1)、(2), 得 $x = 0$.

将 $x = -a$ 代入(1)式, 得 $(a-x)x^2 = 0$. 若 $a \neq 0$, 则得出矛盾的结果. 若 $a = 0$, 则也得到 $x = 0$, $y = 0$, 故点 $(0, 0)$ 为奇点.

又因 $A = F''_{xx}(0, 0) = -2a$, $B = F''_{xy}(0, 0) = 0$, $C = F''_{yy}(0, 0) = 2a$, 且 $AC - B^2 = -4a^2$, 故当 $a \neq 0$ 时, 点 $(0, 0)$ 为二重点; 当 $a = 0$ 时, 方程转化为 $xy^2 = -x^3$, 从而曲线为 $x = 0$, 点 $(0, 0)$ 为上升点.

如图 6.38 所示, 图中点 A_1 为 $(a, 0)$



图 6.38

3612. 研究参变量 a, b, c ($a \leq b \leq c$) 的值与曲线 $y^2 = (x-a) \cdot (x-b)(x-c)$ 的形状之关系.

解 解方程组

$$\begin{cases} F(x, y) = y^2 - (x-a)(x-b)(x-c) = 0, & (1) \\ F'_x(x, y) = -(x-a)(x-b) - (x-a) \\ \quad \cdot (x-c) - (x-b)(x-c) = 0, & (2) \\ F'_y(x, y) = 2y = 0. & (3) \end{cases}$$

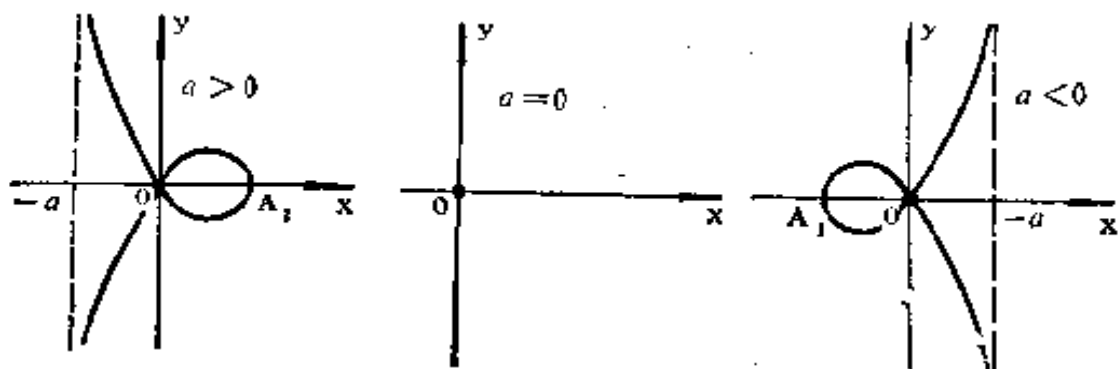
由(3)得 $y=0$, 代入(1), 联立(1), (2)求解.

当 $a < b < c$ 时, (1), (2)无解. 因此无奇点, 此时曲线如图 6.39(1)所示;

当 $a = b < c$ 时, 显然(1), (2)有解 $x=a, y=0$, 由于 $A = F''_{xx}(a, 0) = -2(a-c)$, $B = F''_{xy}(a, 0) = 0$, $C = F''_{yy}(a, 0) = 2$, 且 $AC - B^2 = -4(a-c) > 0$, 故点 $A_1(a, 0)$ 为孤立点, 如图 6.39(2)所示;

当 $a < b = c$ 时, 显然(1), (2)有解 $x=b, y=0$. 由于 $A = F''_{xx}(b, 0) = -2(c-a)$, $B = F''_{xy}(b, 0) = 0$, $C = F''_{yy}(b, 0) = 2$, 且 $AC - B^2 = -4(c-a) < 0$, 故点 $A_2(b, 0)$ 为二重点, 如图 6.39(3)所示;

当 $a=b=c$ 时, 显然有解 $x=a, y=0$. 由于 $AC - B^2 = 0$, 此时原方程为 $y^2 = (x-a)^3$, 且由3574题(6)的结果知, 点 $A_1(a, 0)$ 为尖点, 如图6·39(4)所示.



图 6·39

研究超越曲线的奇点:

3613. $y^2 = 1 - e^{-x^2}$.

解 解方程组

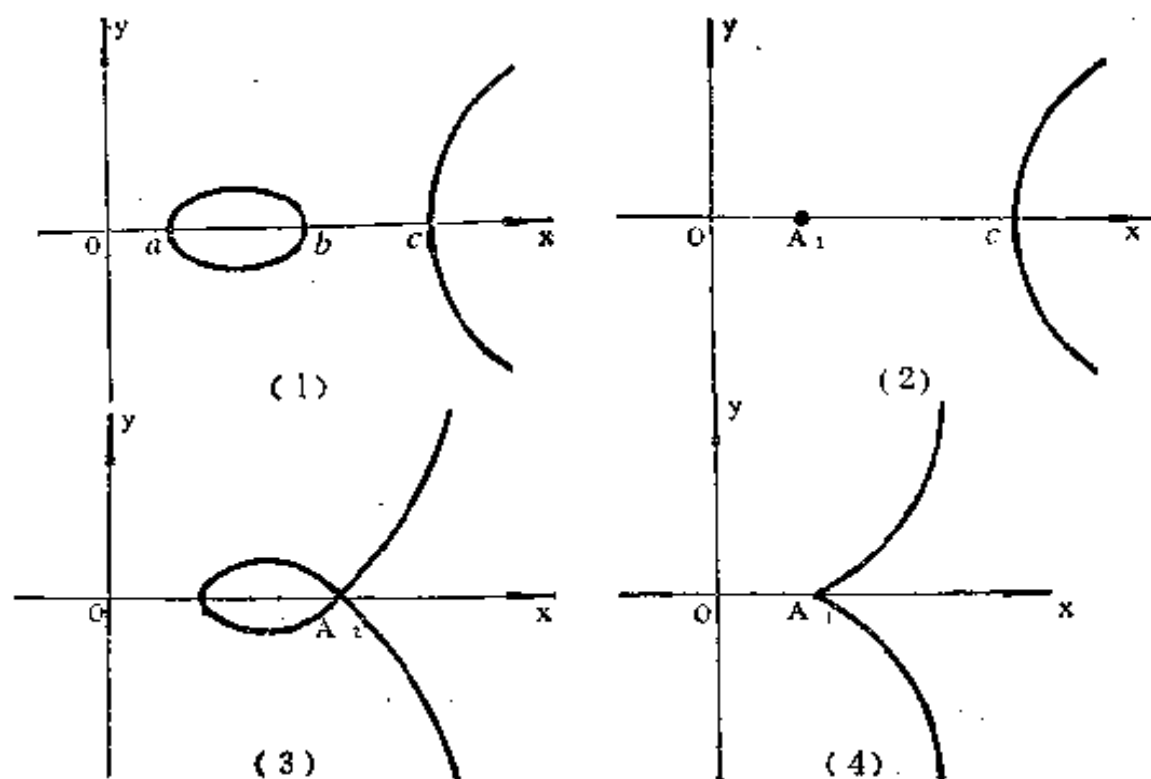
$$\begin{cases} F(x, y) = y^2 - 1 + e^{-x^2} = 0, \\ F'_x(x, y) = -2xe^{-x^2} = 0, \\ F'_y(x, y) = 2y = 0 \end{cases}$$

得 $x=0, y=0$, 故点 $(0, 0)$ 为奇点.

又 $A = F''_{xx}(0, 0) = -2$, $B = F''_{xy}(0, 0) = 0$, $C = F''_{yy}(0, 0) = 2$, 且 $AC - B^2 = -4 < 0$, 故点 $(0, 0)$ 为二重点.

3614. $y^2 = 1 - e^{-x^3}$.

解 解方程组

$$\begin{cases} F(x, y) = y^2 - 1 + e^{-x^3} = 0, \\ F'_x(x, y) = -3x^2 e^{-x^3} = 0, \\ F'_y(x, y) = 2y = 0 \end{cases}$$

得 $x=0, y=0$, 故点 $(0, 0)$ 为奇点.

又因 $A = F''_{xx}(0, 0) = 0$, $B = F''_{xy}(0, 0) = 0$, $C = F''_{yy}(0, 0) = 2$, 且 $AC - B^2 = 0$, 故对点 $(0, 0)$ 还需再讨论一下. 原式可解为 $x = -\sqrt[3]{\ln(1-y^2)} > 0$, 在 $(0, 0)$ 附近, 第一及第四象限各有原曲线的一支, 因此, 点 $(0, 0)$ 为尖点.

3615. $y = x \ln x$.

解 $F(x, y) = x \ln x - y$,
 $F'_x(x, y) = 1 + \ln x$, $F'_y(x, y) = -1 \neq 0$, 故无奇点. 如图 6.40 所示.



图 6.40

3616. $y = \frac{x}{1+e^{\frac{1}{x}}}$.

解 在 $x=0$ 处, 由于

$$\lim_{x \rightarrow +0} y = \lim_{x \rightarrow -0} y = 0,$$

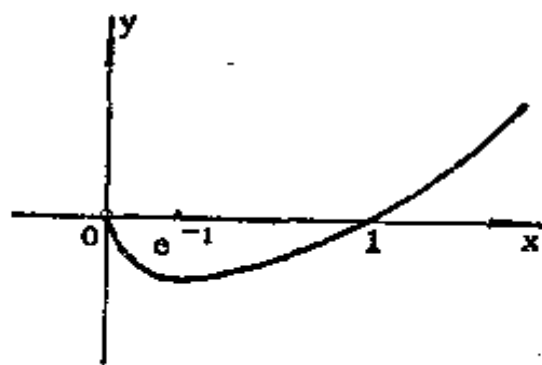
故 $x=0$ 为“可移去”的第一类不连续点, 补充函数在该点的值为零后, 即得知函数

$$y = \begin{cases} \frac{x}{1+e^{\frac{1}{x}}}, & x \neq 0, \\ 0, & x = 0 \end{cases}$$

在点 $x=0$ 连续. 由于 $F'_x(x, y) = 1 \neq 0$, 故无奇点.
当 $x \neq 0$ 时, 由于,

$$y' = \frac{\left(1 + \frac{1}{x}\right)e^{\frac{1}{x}} + 1}{\left(1 + e^{\frac{1}{x}}\right)^2},$$

$$\lim_{x \rightarrow +0} y' = \lim_{z \rightarrow +\infty} \frac{(1+z)e^z + 1}{(1+e^z)^2} = \lim_{z \rightarrow +\infty} \frac{e^z(z+2)}{2e^z(1+e^z)}$$

$$= \lim_{z \rightarrow +\infty} \frac{z+2}{2(1+e^z)} = 0,$$

$$\lim_{x \rightarrow -0} y'$$

$$= \lim_{z \rightarrow +\infty} \frac{(1-z)e^{-z} + 1}{(1+e^{-z})^2} = 1,$$

故点 $(0,0)$ 为角点, 如图 6.41 所示



图 6.41

3617. $y = \operatorname{arctg}\left(\frac{1}{\sin x}\right).$

解 $x = k\pi$ ($k=0, \pm 1, \pm 2, \dots$) 点为不连续点. 由于

$$\lim_{x \rightarrow k\pi+0} y = (-1)^k \frac{\pi}{2}, \quad \lim_{x \rightarrow k\pi-0} y = (-1)^{k+1} \frac{\pi}{2},$$

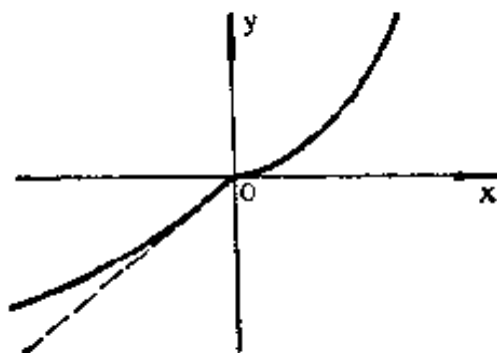
故点 $x = k\pi$ 为函数的第一类不连续点.

3618. $y^2 = \sin \frac{\pi}{x}.$

解 $y = \pm \sqrt{\sin \frac{\pi}{x}}$, 它在 $(\frac{1}{2k}, \frac{1}{2k-1})$ ($k = \pm 1, \pm 2, \dots$) 内无定义.

在边界点 $x = \frac{1}{2k}$ 及 $x = \frac{1}{2k-1}$, $y = 0$.

函数图象有上下两支.

设 $F(x, y) = y^2 - \sin \frac{\pi}{x}$, 则在边界点, 由于 $F'_x \neq 0$, $F'_y = 0$, 故也无奇点.

在 $(0, 0)$ 点的任何邻域内, 有无穷多个曲线的封闭分支, 这些分支没有一个过 $(0, 0)$ 点, 它不属于任何一种类型.

3619. $y^2 = \sin x^2$.

解 解方程组

$$\begin{cases} F(x, y) = y^2 - \sin x^2 = 0, \\ F'_x(x, y) = -2x \cos x^2 = 0, \\ F'_y(x, y) = 2y = 0 \end{cases}$$

得 $x = 0$, $y = 0$, 故点 $(0, 0)$ 为奇点.

又因 $A = F''_{xx}(0, 0) = -2$, $B = F''_{xy}(0, 0) = 0$, $C = F''_{yy}(0, 0) = 2$, 且 $AC - B^2 = -4 < 0$, 故点 $(0, 0)$ 为二重点.

3620. $y^2 = \sin^3 x$.

解 显见, 函数 y 的周期为 2π , 在 $(2k\pi, (2k+1)\pi)$ 内函数有定义, 而在 $((2k-1)\pi, 2k\pi)$ ($k = 0, \pm 1, \pm 2, \dots$) 内无定义.

解方程组

$$\begin{cases} F(x, y) = y^2 - \sin^3 x = 0, \\ F'_x(x, y) = -3\sin^2 x \cos x = 0, \\ F'_y(x, y) = 2y = 0 \end{cases}$$

得 $x=0$, $y=0$, 故点 $(0,0)$ 为奇点.

在点 $(0,0)$ 的左侧 (指充分小的范围, 下同, 不再说明) 无曲线的点, 而在右侧的第一、第四象限分别有曲线的两枝, 因此, 点 $(0,0)$ 为尖点, 如图 6.42 所示.

由周期性可知, 点 $(k\pi, 0)$ ($k = \pm 1, \pm 2, \dots$) 也为尖点. 只是当 k 是偶数时, 右侧才有曲线的两枝; 当 k 是奇数时, 左侧才有曲线的两枝.



图 6.42

§7. 多变量函数的极值

1° 极值的定义 若函数 $f(P) = f(x_1, \dots, x_n)$ 于点 P_0 的邻域内有定义并且当 $0 < \rho(P_0, P) < \delta$ 时, $f(P_0) > f(P)$ 或 $f(P_0) < f(P)$, 则说, 函数 $f(P)$ 在点 P_0 有极值 (相应地为极大值或极小值).*)

2° 极值的必要条件 可微分的函数 $f(P)$ 仅在静止点 P_0 , 即是说在 $df(P_0) = 0$ 的点 P_0 能达到极值. 所以, 函数 $f(P)$ 的极值点应当满足方程组 $f'_i(x_1, \dots, x_n) = 0$ ($i = 1, \dots, n$).

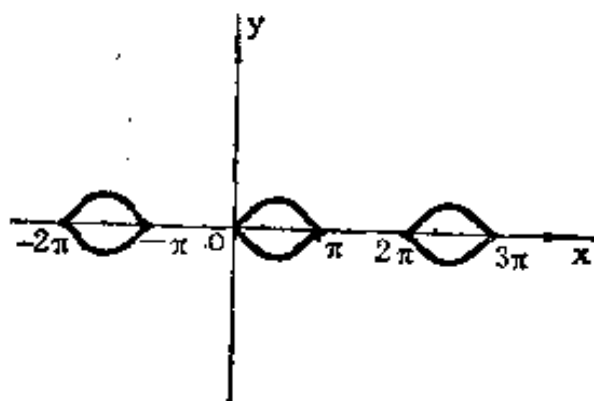
3° 极值的充分条件 函数 $f(P)$ 于点 P_0 有:

(a) 极大值, 若 $df(P_0) = 0$, $d^2f(P_0) < 0$,

(b) 极小值, 若 $df(P_0) = 0$, $d^2f(P_0) > 0$.

研究二次微分 $d^2f(P_0)$ 的符号可用化相应的二次式成典式的方法来进行.

特别是, 对于两个自变量 x 和 y 的函数 $f(x, y)$ 在静止点 (x_0, y_0) [$df(x_0, y_0) = 0$], $D = AC - B^2 \neq 0$ [其中 $A = f''_{xx}(x_0, y_0)$, $B = f''_{xy}(x_0, y_0)$, $C = f''_{yy}(x_0, y_0)$] 成立时, 有:

(1) 极小值, 若 $D > 0$, $A > 0$ ($C > 0$);

(2) 极大值, 若 $D > 0$, $A < 0$ ($C < 0$);

(3) 极值不存在, 若 $D < 0$.

4° 条件极值 在关系式 $\varphi_i(P) = 0$ ($i = 1, \dots, m$; $m < n$)

*) 编者注: 若将不等式 $f(P_0) > f(P)$ (或 $f(P_0) < f(P)$) 换为不等式 $f(P_0) \geq f(P)$ (或 $f(P_0) \leq f(P)$), 则称 $f(P)$ 在点 P_0 有弱极大值 (或弱极小值).

存在的条件下, 求函数 $f(P_0) = f(x_1, x_2, \dots, x_n)$ 的极值的问题, 可归结为对于拉格朗日函数

$$L(P) = f(P) + \sum_{i=1}^m \lambda_i \varphi_i(P)$$

[其中 $\lambda_i (i = 1, \dots, m)$ 为常数因子] 求普通极值的问题. 关于条件极值的存在和性质的问题, 在最简单的情况, 根据研究函数 $L(P)$ 于静止点 P_0 的二次微分 $d^2L(P_0)$ 的符号, 并在变量 dx_1, dx_2, \dots, dx_n 由下面的关系式

$$\sum_{i=1}^m \frac{\partial \varphi_i}{\partial x_j} dx_j = 0 \quad (i = 1, \dots, m)$$

所限制的条件下, 得到解决.

5° **绝对极值** 于有界且封闭的区域内可微分的函数 $f(P)$ 在此域内或于静止点, 或于域的边界点达到自己的最大值和最小值.

研究下列多变量函数的极值:

3621. $z = x^2 + (y-1)^2$.

解 解方程组

$$\begin{cases} \frac{\partial z}{\partial x} = 2x = 0, \\ \frac{\partial z}{\partial y} = 2(y-1) = 0 \end{cases}$$

得静止点 $P_0(0, 1)$. 显然 $z(0, 1) = 0$, 且当 $(x, y) \neq (0, 1)$ 时 $z > 0$, 故函数 z 在点 P_0 取得极小值 $z(P_0) = 0$ (实际是最小值).

3622. $z = x^2 - (y-1)^2$.

解 解方程组

$$\begin{cases} \frac{\partial z}{\partial x} = 2x = 0, \\ \frac{\partial z}{\partial y} = -2(y-1) = 0 \end{cases}$$

得静止点 $P_0(0, 1)$ 。由于

$A = z''_{xx}(0, 1) = 2$, $B = z''_{xy}(0, 1) = 0$, $C = z''_{yy}(0, 1) = -2$, 且 $AC - B^2 = -4 < 0$, 故极值不存在(或用该点附近的 z 值可正可负说明)。

3623. $z = (x - y + 1)^2$.

解 解方程组

$$\begin{cases} \frac{\partial z}{\partial x} = 2(x - y + 1) = 0, \\ \frac{\partial z}{\partial y} = -2(x - y + 1) = 0 \end{cases}$$

得静止点分布在直线 $x - y + 1 = 0$ 上。对于此直线上的点均有 $z = 0$, 但是 $z \geq 0$ 恒成立。因此, 函数 z 在直线 $x - y + 1 = 0$ 上的各点取得弱极小值 $z = 0$ 。

3624. $z = x^2 - xy + y^2 - 2x + y$.

解 解方程组

$$\begin{cases} \frac{\partial z}{\partial x} = 2x - y - 2 = 0, \\ \frac{\partial z}{\partial y} = -x + 2y + 1 = 0 \end{cases}$$

得静止点 $P_0(1, 0)$ 。由于

$A = z''_{xx}(1, 0) = 2$, $B = z''_{xy}(1, 0) = -1$, $C = z''_{yy}(1, 0) = 2$, 且 $AC - B^2 = 3 > 0$, 故函数 z 在点

P_0 取得极小值 $z(P_0) = -1$.

3625. $z = x^2 y^3 (6 - x - y)$.

解 解方程组

$$\begin{cases} \frac{\partial z}{\partial x} = xy^3(12 - 3x - 2y) = 0, \\ \frac{\partial z}{\partial y} = x^2 y^2(18 - 3x - 4y) = 0 \end{cases}$$

得静止点 $P_0(2, 3)$, 并且直线 $x = 0$ 及直线 $y = 0$ 上的点都是静止点.

不难断定在 P_0 点, $A = -162$, $B = -108$, $C = -144$, $AC - B^2 > 0$, 故函数 z 在点 P_0 取得极大值 $z(P_0) = 108$.

在直线 $x = 0$ 及 $y = 0$ 上的各点均有 $z = 0$. 先分析直线 $y = 0$ 的情况. 在直线上 $x \neq 0$ 及 $x \neq 6$ 处, $x^2(6 - x - y) \neq 0$, 在确定点的足够小的邻域内也不变号, 但是 y^3 可正可负, 因此函数 z 变号, 即在上述情况下没有极值. 当 $x = 0$ 及 $x = 6$ 类似地可判断也无极值.

其次分析直线 $x = 0$ 的情况. 在直线上 $y = 0$ 及 $y = 6$ 的点的情况类似地可判断无极值. 但当 $0 < y < 6$ 时, $y^3(6 - x - y) > 0$, 且在所讨论点的足够小的邻域内保持正号. 因此, 在足够小的邻域内, $z = x^2 y^3 \cdot (6 - x - y) \geq 0$ 也成立, 但邻域内任意近处总有 $z = 0$ 的点. 于是, 对于 $x = 0$, $0 < y < 6$ 的点函数 z 取得弱极小值 $z = 0$. 同法可判定, 对于直线 $x = 0$ 上 $y < 0$ 及 $y > 6$ 的各点处, 函数 z 取得弱极大值 $z = 0$.

3626. $z = x^3 + y^3 - 3xy.$

解 解方程组

$$\begin{cases} \frac{\partial z}{\partial x} = 3x^2 - 3y = 0, \\ \frac{\partial z}{\partial y} = 3y^2 - 3x = 0 \end{cases}$$

得静止点 $P_0(0,0)$ 及 $P_1(1,1)$.

不难断定, 在点 P_0 有 $A=0$, $B=-3$, $C=0$ 及 $AC-B^2=-9 < 0$, 故无极值; 而在点 P_1 有 $A=6$, $B=-3$, $C=6$ 及 $AC-B^2=27 > 0$, 故函数 z 在该点取得极小值 $z(P_1)=-1$.

3627. $z = x^4 + y^4 - x^2 - 2xy - y^2.$

解 解方程组

$$\begin{cases} \frac{\partial z}{\partial x} = 4x^3 - 2x - 2y = 0, \\ \frac{\partial z}{\partial y} = 4y^3 - 2x - 2y = 0 \end{cases}$$

得静止点 $P_0(0,0)$, $P_1(1,1)$ 及 $P_2(-1,1)$.

在点 P_0 附近, 当 $x=y$ 且足够小时, 有 $z=2x^4-4x^2 < 0$; 但当 $x=-y$ 时, $z=2x^4 > 0$, 因此, 在点 P_0 无极值.

不难断定, 在点 P_1 及 P_2 均有 $A=10$, $B=-2$, $C=10$ 及 $AC-B^2=96 > 0$, 故函数 z 在点 P_1 及 P_2 取得极小值 $z=-2$.

3628. $z = xy + \frac{50}{x} + \frac{20}{y} \quad (x > 0, y > 0).$

解 解方程组

$$\begin{cases} \frac{\partial z}{\partial x} = y - \frac{50}{x^2} = 0, \\ \frac{\partial z}{\partial y} = x - \frac{50}{y^2} = 0 \end{cases}$$

得静止点 $P_0(5, 2)$. 不难断定, 在该点有 $A = \frac{4}{5}$,

$B = 1$, $C = 5$ 及 $AC - B^2 = 3 > 0$, 故函数 z 在该点取得极小值 $z(P_0) = 30$.

3629. $z = xy\sqrt{1 - \frac{x^2}{a^2} - \frac{y^2}{b^2}}$ ($a > 0$, $b > 0$).

解 考虑函数 $u = z^2 = x^2 y^2 \left(1 - \frac{x^2}{a^2} - \frac{y^2}{b^2}\right)$, $\frac{x^2}{a^2} + \frac{y^2}{b^2} \leq 1$.

显然 z 的极值均为 u 的极值; 且 u 在点 (x, y) 取得的极值不为零时, z 也在点 (x, y) 取得极值; u 在点 (x, y) 取得的极值为零时, 情况复杂一些, 但对 z 也不难讨论.

解方程组

$$\begin{cases} \frac{\partial u}{\partial x} = 2xy^2 \left(1 - \frac{x^2}{a^2} - \frac{y^2}{b^2}\right) - \frac{2}{a^2} x^3 y^2 = 0, \\ \frac{\partial u}{\partial y} = 2x^2 y \left(1 - \frac{x^2}{a^2} - \frac{y^2}{b^2}\right) - \frac{2}{b^2} x^2 y^3 = 0 \end{cases}$$

得静止点 $P_0(0, 0)$, $P_1\left(\frac{a}{\sqrt{3}}, \frac{b}{\sqrt{3}}\right)$, $P_2\left(-\frac{a}{\sqrt{3}},$

$-\frac{b}{\sqrt{3}}\right)$, $P_3\left(\frac{a}{\sqrt{3}}, -\frac{b}{\sqrt{3}}\right)$ 及 $P_4\left(-\frac{a}{\sqrt{3}}, \frac{b}{\sqrt{3}}\right)$.

由于 z 在点 P_0 附近变号, 所以 $z(P_0)$ 不是极值。

$$\frac{\partial^2 u}{\partial x^2} = 2y^2 \left(1 - \frac{6x^2}{a^2} - \frac{y^2}{b^2} \right),$$

$$\frac{\partial^2 u}{\partial y^2} = 2x^2 \left(1 - \frac{x^2}{a^2} - \frac{6y^2}{b^2} \right),$$

$$\frac{\partial^2 u}{\partial x \partial y} = 4xy \left(1 - \frac{2x^2}{a^2} - \frac{2y^2}{b^2} \right).$$

在 P_1, P_2, P_3, P_4 各点, 得

$$A = -\frac{8}{9}b^2, \quad B = \pm \frac{4}{9}ab, \quad C = -\frac{8}{9}a^2,$$

$$AC - B^2 = \left(\frac{64}{81} - \frac{16}{81} \right) a^2 b^2 > 0,$$

故函数 u 取得正的极大值. 于是, 相应地函数 z 在点

P_1 及 P_2 取得极大值 $z(P_1) = z(P_2) = \frac{ab}{3\sqrt{3}}$, 而在点

P_3 及 P_4 取得极小值 $z(P_3) = z(P_4) = -\frac{ab}{3\sqrt{3}}$.

3630. $z = \frac{ax + by + c}{\sqrt{x^2 + y^2 + 1}} \quad (a^2 + b^2 + c^2 \neq 0).$

解 令 $x = r \cos \varphi, y = r \sin \varphi$, 则

$$z(x, y) = z(r \cos \varphi, r \sin \varphi) = \frac{a r \cos \varphi + b r \sin \varphi + c}{\sqrt{r^2 + 1}}.$$

解方程组

$$\begin{cases} \frac{\partial z}{\partial r} = \frac{a \cos \varphi + b \sin \varphi - cr}{(1+r^2)^{\frac{3}{2}}} = 0, & (1) \end{cases}$$

$$\begin{cases} \frac{\partial z}{\partial \varphi} = \frac{-ar \sin \varphi + br \cos \varphi}{(1+r^2)^{\frac{1}{2}}} = 0. & (2) \end{cases}$$

先设 a, b 不同时为零. 由 (2) 考虑到 $r=0$ 不是解 ($r=0, \varphi$ 为任意值不满足 (1) 式), 故有 $a \sin \varphi = b \cos \varphi$. 于是,

$$\cos \varphi = \frac{\pm a}{\sqrt{a^2 + b^2}}, \quad \sin \varphi = \frac{\pm b}{\sqrt{a^2 + b^2}}. \quad (3)$$

显见当 $c=0$ 时无解 (因由 (1) 有 $a \cos \varphi + b \sin \varphi = 0$, 再由 (3) 得 $a=b=0$. 与 a, b 不同时为零之假定矛盾). 当 $c \neq 0$ 时,

$$r = \frac{a \cos \varphi + b \sin \varphi}{c} = \pm \frac{\sqrt{a^2 + b^2}}{c}.$$

为保证 $r > 0$, 在 $\cos \varphi$ 及 $\sin \varphi$ 前取与 c 一致的符号. 此时, 有

$$x = \frac{a}{c}, \quad y = \frac{b}{c}.$$

$$\text{由于这时 } z''_{rr} = -\frac{c(1+3r^2)}{(1+r^2)^{\frac{5}{2}}},$$

$$z''_{\varphi\varphi} = -\frac{cr^2}{(1+r^2)^{\frac{3}{2}}}, \quad z''_{r\varphi} = 0$$

及 $z''_{rr} z''_{\varphi\varphi} - (z''_{r\varphi})^2 > 0$, 故当 $c > 0$ 时 $z''_{rr} < 0$, 函数 z 在点 $(\frac{a}{c}, \frac{b}{c})$ 取得极大值 $z = \sqrt{a^2 + b^2 + c^2}$; 当 $c < 0$ 时 $z''_{rr} > 0$, 函数 z 在点 $(\frac{a}{c}, \frac{b}{c})$ 取得极小值 $z = -\sqrt{a^2 + b^2 + c^2}$.

下设 $a=b=0$. 由假定 $a^2 + b^2 + c^2 \neq 0$ 知 $c \neq 0$.

此时解方程组(1), (2)得 $r=0$, φ 任意; 即 $x=0$,

$y=0$. 由于这时 $z = \frac{c}{\sqrt{x^2+y^2+1}}$, 故显然知: 当

$c > 0$ 时 z 在点 $(0,0)$ 取极大值 $z=c$; 当 $c < 0$ 时, z 在点 $(0,0)$ 取极小值 $z=c$.

综合上述结果, 得结论: 若 $c > 0$, 则 z 在点

$(\frac{a}{c}, \frac{b}{c})$ 取极大值 $z_{\text{极大}} = \sqrt{a^2+b^2+c^2}$; 若 $c < 0$,

则 z 在点 $(\frac{a}{c}, \frac{b}{c})$ 取极小值 $z_{\text{极小}} = -\sqrt{a^2+b^2+c^2}$;

若 $c=0$ (由假定, 这时 $a^2+b^2 \neq 0$), 则 z 无极值.

注. 此题也可不作变量代换 $x=r\cos\varphi, y=r\sin\varphi$, (极坐标), 而直接在直角坐标 x, y 下进行讨论, 即

解方程组 $\frac{\partial z}{\partial x} = 0, \frac{\partial z}{\partial y} = 0$ 并计算 $\frac{\partial^2 z}{\partial x^2}, \frac{\partial^2 z}{\partial x \partial y},$

$\frac{\partial^2 z}{\partial y^2}$ 之值. 但此法计算较繁, 没有用极坐标简单.

3631. $z = 1 - \sqrt{x^2 + y^2}$.

解 $\frac{\partial z}{\partial x} = -\frac{x}{\sqrt{x^2+y^2}}, \frac{\partial z}{\partial y} = -\frac{y}{\sqrt{x^2+y^2}}$.

点 $(0,0)$ 为偏导函数无意义的点. 当 $(x,y) \neq (0,0)$ 时, $z < 1$, 故 $z(0,0) = 1$ 为极大值.

3632. $z = e^{2x+3y}(8x^2 - 6xy + 3y^2)$.

解 解方程组

$$\begin{cases} \frac{\partial z}{\partial x} = 2e^{2x+3y}(8x^2 - 6xy + 3y^2 + 8x - 3y) = 0, \\ \frac{\partial z}{\partial y} = 3e^{2x+3y}(8x^2 - 6xy + 3y^2 - 2x + 2y) = 0 \end{cases}$$

得静止点 $P_0(0,0)$ 及 $P_1(-\frac{1}{4}, -\frac{1}{2})$.

$$\frac{\partial^2 z}{\partial x^2} = 4e^{2x+3y}(8x^2 - 6xy + 3y^2 + 16x - 6y + 4),$$

$$\frac{\partial^2 z}{\partial y^2} = 9e^{2x+3y}(8x^2 - 6xy + 3y^2 - 4x + 4y + \frac{2}{3}),$$

$$\frac{\partial^2 z}{\partial x \partial y} = 6e^{2x+3y}(8x^2 - 6xy + 3y^2 + 6x - y - 1).$$

在点 P_0 , $A=16$, $B=-6$, $C=6$ 及 $AC-B^2=60>0$,
故函数 z 取得极小值 $z(P_0)=0$, 在点 P_1 , $A=14e^{-2}$,

$B=-9e^{-2}$, $C=\frac{3}{2}e^{-2}$ 及 $AC-B^2=-60e^{-4}<0$, 故

无极值.

3633. $z=e^{x^2-y}(5-2x+y)$.

解 解方程组

$$\begin{cases} \frac{\partial z}{\partial x} = 2e^{x^2-y}(5x - 2x^2 + xy - 1) = 0, \\ \frac{\partial z}{\partial y} = e^{x^2-y}(2x - y - 4) = 0 \end{cases}$$

得静止点 $P_0(1, -2)$.

$$\frac{\partial^2 z}{\partial x^2} = 2e^{x^2-y}(10x^2 - 4x^3 + 2x^2y - 6x + y + 5),$$

$$\frac{\partial^2 z}{\partial y^2} = e^{x^2-y} (3 - 2x + y),$$

$$\frac{\partial^2 z}{\partial x \partial y} = 2e^{x^2-y} (2x^2 - xy - 4x + 1).$$

在点 P_0 , $A = -2e^6$, $B = 2e^6$, $C = -e^6$ 及 $AC - B^2 = -2e^6 < 0$, 故无极值.

3634. $z = (5x + 7y - 25)e^{-(x^2 + xy + y^2)}$.

解 解方程组

$$\begin{cases} \frac{\partial z}{\partial x} = 5e^{-(x^2 + xy + y^2)} - (5x + 7y - 25) \\ \quad \cdot (2x + y)e^{-(x^2 + xy + y^2)} = 0, \quad (1) \\ \frac{\partial z}{\partial y} = 7e^{-(x^2 + xy + y^2)} - (5x + 7y - 25) \\ \quad \cdot (x + 2y)e^{-(x^2 + xy + y^2)} = 0. \quad (2) \end{cases}$$

(1) $\times 7 -$ (2) $\times 5$, 消去因子 $e^{-(x^2 + xy + y^2)}$, 得

$$3(5x + 7y - 25)(3x - y) = 0.$$

以 $5x + 7y - 25 = 0$ 代入 (1)、(2), 显然矛盾, 故必有 $5x + 7y - 25 \neq 0$, 从而 $y = 3x$. 代入 (1), 得

$$26x^2 - 25x - 1 = 0,$$

解得静止点 $P_0(1, 3)$ 及 $P_1(-\frac{1}{26}, -\frac{3}{26})$. 在点 P_0 ,

$$\begin{aligned} A &= z''_{xx}(P_0) = [z'_x(x, 3)]'_x|_{x=1} \\ &= \{e^{-(x^2 + 3x + 9)} [5 - (5x - 4)(2x + 3)]\}'_x|_{x=1} \\ &= [e^{-(x^2 + 3x + 9)}]'_x|_{x=1} \cdot [5 - (5x - 4)(2x + 3)]|_{x=1} \\ &\quad + [e^{-(x^2 + 3x + 9)}]_{x=1} \cdot [5 - (5x - 4) \\ &\quad \cdot (2x + 3)]'_x|_{x=1} \\ &= -27e^{-18}. \end{aligned}$$

同法可求得

$$B = z''_{xx}(P_0) = -36e^{-13}, C = z''_{yy}(P_0) = -51e^{-13}.$$

于是, $AC - B^2 = 81e^{-26} > 0$, 故函数 z 在点 P_0 取得极大值 $z(P_0) = e^{-13} \approx 2.26 \cdot 10^{-6}$.

同法可得函数 z 在点 P_1 取得极小值 $z(P_1) = -26e^{-\frac{1}{52}} \approx -25.51$.

3635. $z = x^2 + xy + y^2 - 4\ln x - 10\ln y.$

解 解方程组

$$\begin{cases} \frac{\partial z}{\partial x} = 2x + y - \frac{4}{x} = 0, \\ \frac{\partial z}{\partial y} = x + 2y - \frac{10}{y} = 0 \end{cases} \quad (x > 0, y > 0)$$

得静止点 $P_0(1, 2)$. 在点 P_0 ,

$$A = 6, B = 1, C = \frac{9}{2}, AC - B^2 = 26 > 0,$$

故函数 z 在点 P_0 取得极小值 $z(P_0) = 7 - 10\ln 2 \approx 0.0635$.

3636. $z = \sin x + \cos y + \cos(x - y)$ ($0 \leq x \leq \frac{\pi}{2}$; $0 \leq y \leq$

$\frac{\pi}{2}$).

解 解方程组

$$\begin{cases} \frac{\partial z}{\partial x} = \cos x - \sin(x - y) = 0, & (1) \\ \frac{\partial z}{\partial y} = -\sin y + \sin(x - y) = 0. & (2) \end{cases}$$

(1) + (2), $\cos x = \sin y$. 由于 x, y 均为锐角, 故有

$y = \frac{\pi}{2} - x$. 代入 (1), 得

$$\begin{aligned}\cos x - \sin\left(2x - \frac{\pi}{2}\right) &= \cos x + \cos 2x \\ &= 2\cos\frac{x}{2}\cos\frac{3x}{2} = 0.\end{aligned}$$

但是 $\cos\frac{x}{2} \neq 0$, 故 $\cos\frac{3x}{2} = 0$. 从而得静止点 $P_0\left(\frac{\pi}{3}, \frac{\pi}{6}\right)$. 由于

$$\frac{\partial^2 z}{\partial x^2} = -\sin x - \cos(x-y),$$

$$\frac{\partial^2 z}{\partial y^2} = -\cos y - \cos(x-y),$$

$$\frac{\partial^2 z}{\partial x \partial y} = \cos(x-y),$$

故在点 P_0 , 有

$$A = -\frac{1+\sqrt{3}}{2}, \quad B = \frac{\sqrt{3}}{2}, \quad C = -\frac{1+\sqrt{3}}{2},$$

$$AC - B^2 = \frac{1+2\sqrt{3}}{4} > 0.$$

于是, 函数 z 在点 P_0 取得极大值 $z(P_0) = \frac{3}{2}\sqrt{3}$.

3637. $z = \sin x \sin y \sin(x+y)$ ($0 \leq x \leq \pi$; $0 \leq y \leq \pi$).

解 解方程组

$$\begin{cases} \frac{\partial z}{\partial x} = \sin y \sin(2x+y) = 0, & (1) \end{cases}$$

$$\begin{cases} \frac{\partial z}{\partial y} = \sin x \sin(x+2y) = 0. & (2) \end{cases}$$

由 (1) 及 (2) 可得下列四个方程组:

$$\text{I: } \begin{cases} \sin x = 0, \\ \sin y = 0. \end{cases} \quad \text{II: } \begin{cases} \sin x = 0, \\ \sin(2x+y) = 0. \end{cases}$$

$$\text{III: } \begin{cases} \sin y = 0, \\ \sin(x+2y) = 0, \end{cases} \quad \text{IV: } \begin{cases} \sin(2x+y) = 0, \\ \sin(x+2y) = 0. \end{cases}$$

考虑到 $0 \leq x \leq \pi$, $0 \leq y \leq \pi$, 于是得原方程组 (1) 与 (2) 的六个解

$$P_1(0, 0), P_2(0, \pi), P_3(\pi, 0),$$

$$P_4(\pi, \pi), P_5\left(\frac{\pi}{3}, \frac{\pi}{3}\right), P_6\left(\frac{2\pi}{3}, \frac{2\pi}{3}\right).$$

由于所考虑的区域是闭正方形 $0 \leq x \leq \pi$, $0 \leq y \leq \pi$, 故点 P_1, P_2, P_3, P_4 都是此区域的边界点. 因此 P_1, P_2, P_3, P_4 不是函数 z 达极值的点 (根据极值的定义, 首先要求函数在所考虑的点的某邻域中有定义). 由于

$$z''_{xx} = 2 \sin y \cos(2x+y), \quad z''_{yy} = \sin 2(x+y),$$

$$z''_{yy} = 2 \sin x \cos(x+2y).$$

在点 P_5 有 $AC - B^2 = (-\sqrt{3})(-\sqrt{3}) - \left(-\frac{\sqrt{3}}{2}\right)^2$

> 0 且 $A = -\sqrt{3} < 0$, 故函数 z 在点 P_5 取得极大值

$z(P_5) = \frac{3\sqrt{3}}{8}$; 在点 P_6 有 $AC - B^2 = (\sqrt{3})(\sqrt{3})$

$-\left(\frac{\sqrt{3}}{2}\right)^2 > 0$ 且 $A = \sqrt{3} > 0$, 故函数 z 在点 P_0 取

得极小值 $z(P_0) = -\frac{3\sqrt{3}}{8}$.

3638. $z = x - 2y + \ln\sqrt{x^2 + y^2} + 3 \operatorname{arctg} \frac{y}{x}$.

解 解方程组

$$\begin{cases} \frac{\partial z}{\partial x} = 1 + \frac{x}{x^2 + y^2} - \frac{3y}{x^2 + y^2} = 0, \\ \frac{\partial z}{\partial y} = -2 + \frac{y}{x^2 + y^2} + \frac{3x}{x^2 + y^2} = 0 \end{cases}$$

得静止点 $P_0(1, 1)$.

$$\frac{\partial^2 z}{\partial x^2} = \frac{-x^2 + 6xy + y^2}{(x^2 + y^2)^2}, \quad \frac{\partial^2 z}{\partial y^2} = \frac{x^2 - 6xy - y^2}{(x^2 + y^2)^2},$$

$$\frac{\partial^2 z}{\partial x \partial y} = \frac{-3x^2 - 2xy + 3y^2}{(x^2 + y^2)^2}.$$

在点 P_0 有 $A = \frac{3}{2}$, $B = -\frac{1}{2}$, $C = -\frac{3}{2}$ 及 $AC - B^2 =$

$-\frac{5}{2} < 0$, 故无极值.

3639. $z = xy \ln(x^2 + y^2)$.

解 解方程组

$$\begin{cases} \frac{\partial z}{\partial x} = y \ln(x^2 + y^2) + \frac{2x^2 y}{x^2 + y^2} = 0, & (1) \\ \frac{\partial z}{\partial y} = x \ln(x^2 + y^2) + \frac{2xy^2}{x^2 + y^2} = 0. & (2) \end{cases}$$

将 (1) 式乘以 x 减去 (2) 式乘以 y , 得

$$\frac{2xy}{x^2+y^2}(x^2-y^2)=0.$$

于是, $x=0$, $y=0$, $x=y$, $x=-y$ 为四组解, 对应地得静止点 $P_1(0,1)$, $P_2(0,-1)$, $P_3(1,0)$

$$P_4(-1,0), P_5\left(\frac{1}{\sqrt{2e}}, \frac{1}{\sqrt{2e}}\right), P_6\left(-\frac{1}{\sqrt{2e}}, -\frac{1}{\sqrt{2e}}\right),$$

$$P_7\left(\frac{1}{\sqrt{2e}}, -\frac{1}{\sqrt{2e}}\right) \text{ 及 } P_8\left(-\frac{1}{\sqrt{2e}}, \frac{1}{\sqrt{2e}}\right).$$

代入原式, 不难看出, 函数 z 在点 P_1 、 P_2 、 P_3 及 P_4 均无极值 (邻域内函数值可正可负). 由于

$$\frac{\partial^2 z}{\partial x^2} = \frac{2xy(x^2+3y^2)}{(x^2+y^2)^2}, \quad \frac{\partial^2 z}{\partial y^2} = \frac{2xy(3x^2+y^2)}{(x^2+y^2)^2},$$

$$\frac{\partial^2 z}{\partial x \partial y} = \ln(x^2+y^2) + \frac{2(x^4+y^4)}{(x^2+y^2)^2}.$$

在点 P_5 及 P_6 , $A=2$, $B=0$, $C=2$ 及 $AC-B^2=4 > 0$, 故函数 z 在点 P_5 及 P_6 取得极小值 $z(P_5)=$

$$z(P_6) = -\frac{1}{2e} \approx -0.184.$$

在点 P_7 及 P_8 , $A=-2$, $B=0$, $C=-2$ 及 $AC-B^2=4 > 0$, 故函数 z 在点 P_7 及 P_8 取极大值 $z(P_7)=$

$$z(P_8) = \frac{1}{2e} \approx 0.184.$$

3640. $z = x + y + 4 \sin x \sin y$.

解 解方程组

$$\begin{cases} \frac{\partial z}{\partial x} = 1 + 4\cos x \sin y = 0, & (1) \end{cases}$$

$$\begin{cases} \frac{\partial z}{\partial y} = 1 + 4\sin x \cos y = 0. & (2) \end{cases}$$

(2) - (1) 得 $\sin(x - y) = 0$, 故 $x - y = n\pi$;

(2) + (1) 得 $\sin(x + y) = \frac{1}{2}$, 故 $x + y = m\pi -$

$$(-1)^m \frac{\pi}{6}.$$

于是, 得静止点 $P_0(x_0, y_0)$, 其中

$$\begin{cases} x_0 = (-1)^{m+1} \frac{\pi}{12} + (m+n) \frac{\pi}{2}, \\ y_0 = (-1)^{m+1} \frac{\pi}{12} + (m-n) \frac{\pi}{2}. \end{cases} \quad (m, n = 0, \pm 1, \pm 2, \dots)$$

在点 P_0 , 有

$$\begin{aligned} AC - B^2 &= (-4\sin x_0 \sin y_0) (-4\sin x_0 \sin y_0) \\ &\quad - (4\cos x_0 \cos y_0)^2 \\ &= 16(\sin x_0 \sin y_0 - \cos x_0 \cos y_0) \\ &\quad \cdot (\sin x_0 \sin y_0 + \cos x_0 \cos y_0) \\ &= -16\cos(x_0 + y_0)\cos(x_0 - y_0) \\ &= -16\cos\left[m\pi - (-1)^m \frac{\pi}{6}\right]\cos n\pi \\ &= -16(-1)^{m+n} \cos \frac{\pi}{6}. \end{aligned}$$

当 m 及 n 有相同的奇偶性时, $m+n$ 为偶数, $AC - B^2 \leq 0$, 故无极值, 当 m 及 n 有不同的奇偶性时, $m+n$

为奇数, $AC - B^2 > 0$, 故有极值, 看 A 的符号决定取得极大值还是极小值. 由于

$$\begin{aligned} A &= -4 \sin x_0 \sin y_0 = 2[\cos(x_0 + y_0) - \cos(x_0 - y_0)] \\ &= 2\{(-1)^m \cos \frac{\pi}{6} - (-1)^n\}, \end{aligned}$$

故当 m 为奇数及 n 为偶数时, $A < 0$, 取得极大值; 当 m 为偶数及 n 为奇数时, $A > 0$, 取得极小值. 极值为

$$z(x_0, y_0) = m\pi + \left(\frac{\pi}{6} + \sqrt{3}\right)(-1)^{m+1} + 2 \cdot (-1)^n.$$

3641. $z = (x^2 + y^2)e^{-(x^2 + y^2)}.$

解 解方程组

$$\begin{cases} \frac{\partial z}{\partial x} = 2xe^{-(x^2 + y^2)}(1 - x^2 - y^2) = 0, \\ \frac{\partial z}{\partial y} = 2ye^{-(x^2 + y^2)}(1 - x^2 - y^2) = 0 \end{cases}$$

得静止点 $P_0(0, 0)$ 及 $P(x_0, y_0)$, 其中 $x_0^2 + y_0^2 = 1$.

在点 P_0 有 $z = 0$, 而当 $(x, y) \neq (0, 0)$ 时 $z > 0$, 故函数 z 在点 P_0 取得极小值 $z = 0$.

由1437题知, 在满足 $x_0^2 + y_0^2 = 1$ 的点 (x_0, y_0) 的邻域内, 不论是 $x^2 + y^2 > 1$ 还是 $x^2 + y^2 < 1$, 均有

$$z(x, y) = (x^2 + y^2)e^{-(x^2 + y^2)} \leq e^{-1}.$$

但是点 (x_0, y_0) 的邻域内总有 $x^2 + y^2 = 1$ 的点 (x, y) , 因此, 函数 z 在点 (x_0, y_0) 取得弱极大值 $z = e^{-1}$.

3642. $u = x^2 + y^2 + z^2 + 2x + 4y - 6z.$

解 $du = 2(x+1)dx + 2(y+2)dy + 2(z-3)dz.$

$$\text{令 } \frac{\partial u}{\partial x} = 2(x+1) = 0, \quad \frac{\partial u}{\partial y} = 2(y+2) = 0,$$

$$\frac{\partial u}{\partial z} = 2(z-3) = 0, \quad \text{得静止点 } P_0(-1, -2, 3).$$

在该点由于

$$d^2u = 2(dx^2 + dy^2 + dz^2) \geq 0$$

(当 $dx^2 + dy^2 + dz^2 \neq 0$ 时),

故函数 u 在点 P_0 取得极小值 $u(P_0) = -14$.

3643. $u = x^3 + y^2 + z^2 + 12xy + 2z$.

解 $du = (3x^2 + 12y)dx + (2y + 12x)dy + (2z + 2)dz$.

$$\text{令 } \frac{\partial u}{\partial x} = 3x^2 + 12y = 0, \quad \frac{\partial u}{\partial y} = 2y + 12x = 0,$$

$$\frac{\partial u}{\partial z} = 2z + 2 = 0, \quad \text{得静止点 } P_0(0, 0, -1) \text{ 及}$$

$$P_1(24, -144, -1).$$

$$d^2u = 6xdx^2 + 2dy^2 + 2dz^2 + 24dxdy.$$

在点 P_0 , 有

$$d^2u = 2dy^2 + 2dz^2 + 24dxdy = 2dz^2 + 2dy(dy + 12dx),$$

当 $dz = 0$, $dy > 0$ 及 $dy + 12dx < 0$ 时, $d^2u < 0$;

而当 dx, dy 及 dz 均大于零时, $d^2u > 0$. 因此 d^2u 的符号不定, 故无极值.

在点 P_1 , 有

$$d^2u = 144dx^2 + 2dy^2 + 2dz^2 + 24dxdy$$

$$= (12dx + dy)^2 + dy^2 + 2dz^2$$

$$\geq 0 \quad (\text{当 } dx^2 + dy^2 + dz^2 \neq 0 \text{ 时}),$$

故函数 u 在点 P_1 取得极小值 $u(P_1) = -6913$.

$$3644. u = x + \frac{y^2}{4x} + \frac{z^2}{y} + \frac{2}{z} \quad (x > 0, y > 0, z > 0).$$

$$\begin{aligned} \text{解 } du &= \left(1 - \frac{y^2}{4x^2}\right) dx + \left(\frac{y}{2x} - \frac{z^2}{y^2}\right) dy \\ &\quad + \left(\frac{2z}{y} - \frac{2}{z^2}\right) dz. \end{aligned}$$

$$\text{令 } \frac{\partial u}{\partial x} = \frac{\partial u}{\partial y} = \frac{\partial u}{\partial z} = 0, \text{ 得方程组}$$

$$\begin{cases} 1 - \frac{y^2}{4x^2} = 0, \\ \frac{y}{2x} - \frac{z^2}{y^2} = 0, \\ \frac{2z}{y} - \frac{2}{z^2} = 0. \end{cases}$$

解之得静止点 $P_0\left(\frac{1}{2}, 1, 1\right)$.

$$\begin{aligned} d^2u &= \frac{y^2}{2x^3} dx^2 - \frac{y}{x^2} dx dy + \left(\frac{1}{2x} + \frac{2z^2}{y^3}\right) dy^2 \\ &\quad - \frac{4z}{y^2} dy dz + \left(\frac{2}{y} + \frac{4}{z^3}\right) dz^2. \end{aligned}$$

在点 P_0 , 有

$$\begin{aligned} d^2u &= 4dx^2 - 4dxdy + 3dy^2 - 4dydz + 6dz^2 \\ &= (2dx - dy)^2 + dy^2 + (dy - 2dz)^2 + 2dz^2 > 0 \end{aligned}$$

(当 $dx^2 + dy^2 + dz^2 \neq 0$ 时),

故函数 u 在点 P_0 取得极小值 $u(P_0) = 4$.

3645. $u = xy^2z^3(a - x - 2y - 3z)$ ($a > 0$).

解 $du = y^2z^3(a - 2x - 2y - 3z)dx + 2xyz^3(a - x - 3y - 3z)dy + 3xy^2z^2(a - x - 2y - 4z)dz$.

令 $\frac{\partial u}{\partial x} = \frac{\partial u}{\partial y} = \frac{\partial u}{\partial z} = 0$, 得方程组

$$\begin{cases} y^2z^3(a - 2x - 2y - 3z) = 0 \\ 2xyz^3(a - x - 3y - 3z) = 0, \\ 3xy^2z^2(a - x - 2y - 4z) = 0. \end{cases}$$

解之得静止点 $P_0(\frac{a}{7}, \frac{a}{7}, \frac{a}{7})$; 直线 $x = 0$, $2y + 3z = a$; 平面 $y = 0$; 平面 $z = 0$.

同 3625 题的方法, 不难确定: 直线 $x = 0$, $2y + 3z = a$ 及平面 $z = 0$ 上的点不取得极值. $y = 0$ 时, 当 $xz^3(a - x - 3z) > 0$ 取得弱极小值 $u = 0$; 当 $xz^3(a - x - 3z) < 0$ 取得弱极大值 $u = 0$; 当 $xz^3(a - x - 3z) = 0$ 不取得极值.

在点 P_0 , 有

$$\begin{aligned} d^2u &= -\frac{2a^5}{7^5} (dx^2 + 3dy^2 + 6dz^2 + 2dxdy + \\ &6dydz + 3dxdz) = -\frac{a^5}{7^5} ((dx + 2dy + 3dz)^2 + dx^2 + \\ &2dy^2 + 3dz^2) < 0 \quad (\text{当 } dx^2 + dy^2 + dz^2 \neq 0 \text{ 时}), \\ \text{故函数 } u \text{ 在点 } P_0 \text{ 取得极大值 } u(P_0) &= \frac{a^7}{7^7}. \end{aligned}$$

$$3646. \quad u = \frac{a^2}{x} + \frac{x^2}{y} + \frac{y^2}{z} + \frac{z^2}{b} \quad (x > 0, y > 0, z > 0, \\ a > 0, b > 0).$$

$$\text{解} \quad du = \left(\frac{2x}{y} - \frac{a^2}{x^2} \right) dx + \left(\frac{2y}{z} - \frac{x^2}{y^2} \right) dy \\ + \left(\frac{2z}{b} - \frac{y^2}{z^2} \right) dz.$$

$$\text{令} \quad \frac{\partial u}{\partial x} = \frac{\partial u}{\partial y} = \frac{\partial u}{\partial z} = 0, \quad \text{得方程组}$$

$$\begin{cases} \frac{2x}{y} - \frac{a^2}{x^2} = 0, \\ \frac{2y}{z} - \frac{x^2}{y^2} = 0, \\ \frac{2z}{b} - \frac{y^2}{z^2} = 0. \end{cases}$$

$$\text{解之得静止点 } P_0 \left(\frac{1}{2} \sqrt[15]{16a^4b}, \frac{1}{4} \sqrt[5]{16a^4b}, \right.$$

$$\left. \frac{1}{2} \sqrt[15]{\frac{1}{4}a^6b^7} \right).$$

$$d^2u = \frac{2a^2}{x^3} dx^2 + \frac{2}{y} dx^2 - \frac{4x}{y^2} dx dy + \frac{2}{z} dy^2 \\ + \frac{2x^2}{y^3} dy^2 - \frac{4y}{z^2} dy dz + \frac{2}{b} dz^2 + \frac{2y^2}{z^3} dz^2. \\ = \frac{2a^2}{x^3} dx^2 + \frac{2}{y} \left(dx - \frac{x}{y} dy \right)^2 + \frac{2}{z} \left(dy - \frac{y}{z} dz \right)^2 \\ + \frac{2}{b} dz^2.$$

在点 P_0 , $x > 0$, $y > 0$, $z > 0$, $d^2u > 0$ (当 $dx^2 + dy^2 + dz^2 \neq 0$ 时), 故函数 u 在点 P_0 取得极小值

$$u(P_0) = \frac{15a^{15}\sqrt{a}}{4\sqrt{16b}}.$$

3647. $u = \sin x + \sin y + \sin z - \sin(x+y+z)$

$$(0 \leq x \leq \pi; 0 \leq y \leq \pi; 0 \leq z \leq \pi).$$

解 $du = [\cos x - \cos(x+y+z)]dx$
 $+ [\cos y - \cos(x+y+z)]dy$
 $+ [\cos z - \cos(x+y+z)]dz.$

令 $\frac{\partial u}{\partial x} = \frac{\partial u}{\partial y} = \frac{\partial u}{\partial z} = 0$, 得方程组

$$\begin{cases} \cos x - \cos(x+y+z) = 0, \\ \cos y - \cos(x+y+z) = 0, \\ \cos z - \cos(x+y+z) = 0. \end{cases}$$

注意到 $0 \leq x \leq \pi$, $0 \leq y \leq \pi$, $0 \leq z \leq \pi$, 解之得静止点 $P_0(0,0,0)$, $P_1(\frac{\pi}{2}, \frac{\pi}{2}, \frac{\pi}{2})$ 及 $P_2(\pi, \pi, \pi)$.

在点 P_1 , 有

$$\begin{aligned} d^2u &= -\sin x dx^2 - \sin y dy^2 - \sin z dz^2 \\ &\quad + \sin(x+y+z)[d(x+y+z)]^2 \\ &= -dx^2 - dy^2 - dz^2 - (dx+dy+dz)^2 < 0, \end{aligned}$$

故函数 u 在点 P_1 取得极大值 $u(P_1) = 4$.

由于 P_0 与 P_2 是所考虑区域 $0 \leq x \leq \pi$, $0 \leq y \leq \pi$, $0 \leq z \leq \pi$ 的边界点, 故函数在点 P_0 与 P_2 不达极值 (根据极值定义, 首先要求函数在所考虑的点的某邻域中有定义). 但如果放宽要求, 对于边界点, 仅将

其函数值与属于所考虑的区域而与此边界点很接近的点的函数值相比较，则在边界点也可引入达极值和达弱极值的概念。今对于点 P_0 及 P_2 的邻域中且属于上述区域的点 (x, y, z) ，显然有 $\sin x \geq 0$ ， $\sin y \geq 0$ ， $\sin z \geq 0$ 。又

$$\begin{aligned} \sin(x+y+z) &= \sin x \cos y \cos z - \sin x \sin y \sin z \\ &\quad + \cos x \sin y \cos z + \cos x \cos y \sin z \\ &\leq \sin x + \sin y + \sin z - \sin x \sin y \sin z, \end{aligned}$$

故 $u \geq 0$ 。而当 $x=y=0$ 时或 $x=y=\pi$ 时都恒有 $u=0$ 。因此，函数 u 在点 P_0 及 P_2 都达到弱极小值 $u(P_0)=u(P_2)=0$ （按上述边界点达极值的意义）。

3648. $u = x_1 x_2^2 \cdots x_n^n (1 - x_1 - 2x_2 - \cdots - nx_n)$
 $(x_1 > 0, x_2 > 0, \dots, x_n > 0)$ 。

解 先考虑满足 $1 - x_1 - 2x_2 - \cdots - nx_n = 0$ ， $x_1 > 0$ ， $x_2 > 0$ ， \dots ， $x_n > 0$ 的点 (x_1, x_2, \dots, x_n) 。显然函数 u 在这种点不达到极值（因为，例如，若保持 x_2, x_3, \dots, x_n 不变，而将 x_1 增大任意小的值，就有 $u < 0$ ，但将 x_1 减小任意小的值，则有 $u > 0$ ），故下面只需

考察满足 $1 - \sum_{k=1}^n kx_k \neq 0$ ， $x_1 > 0$ ， \dots ， $x_n > 0$ 的点 (x_1, x_2, \dots, x_n) 。

我们有

$$du = u \sum_{k=1}^n \frac{k}{x_k} dx_k - \frac{u}{1 - \sum_{k=1}^n kx_k} \sum_{k=1}^n k dx_k$$

$$= u \left[\sum_{k=1}^n \left(\frac{k}{x_k} - \frac{k}{1 - \sum_{k=1}^n kx_k} \right) dx_k \right],$$

考虑到 $x_i \geq 0$ 及 $1 - \sum_{k=1}^n kx_k \neq 0$, 故有 $u \neq 0$.

解方程组

$$\frac{k}{x_k} - \frac{k}{1 - \sum_{k=1}^n kx_k} = 0 \quad (k=1, 2, \dots, n)$$

得静止点 $P_0(x_1, x_2, \dots, x_n)$, 其中

$$x_1 = x_2 = \dots = x_n = \frac{2}{n^2 + n + 2} = x_0.$$

$$\begin{aligned} d^2u &= \left[\sum_{k=1}^n \left(\frac{k}{x_k} - \frac{k}{1 - \sum_{k=1}^n kx_k} \right) dx_k \right] du \\ &+ u \left[\sum_{k=1}^n \left(-\frac{k}{x_k^2} \right) dx_k^2 + \frac{1}{\left(1 - \sum_{k=1}^n kx_k \right)^2} \right. \\ &\quad \left. \cdot \left(\sum_{k=1}^n k dx_k \right) \left(-\sum_{k=1}^n k dx_k \right) \right]. \end{aligned}$$

在点 P_0 , 有

$$d^2u = -\frac{u}{x_0^2} \left[\sum_{k=1}^n k dx_k^2 + \left(\sum_{k=1}^n k dx_k \right)^2 \right]$$

$$= -x_0^{\frac{n(n+1)}{2}-1} \left[\sum_{k=1}^n k dx_k^2 + \left(\sum_{k=1}^n k dx_k \right)^2 \right]$$

$$< 0 \quad (\text{当 } \sum_{k=1}^n dx_k^2 \neq 0 \text{ 时}),$$

故函数 u 在点 P_0 取得极大值 $u(P_0) = \left(\frac{2}{n^2+n+2} \right)^{\frac{n^2+n+2}{2}}$.

3649. $u = x_1 + \frac{x_2}{x_1} + \frac{x_3}{x_2} + \cdots + \frac{x_n}{x_{n-1}} + \frac{2}{x_n}$ ($x_i > 0, i = 1, 2, \dots, n$).

解 设 $y_1 = x_1, y_2 = \frac{x_2}{x_1}, \dots, y_k = \frac{x_k}{x_{k-1}}, \dots, y_n = \frac{x_n}{x_{n-1}}$,

则 $x_n = y_1 y_2 \cdots y_n, y_k > 0 (k = 1, 2, \dots, n)$ 且

$$u = y_1 + y_2 + y_3 + \cdots + \frac{2}{y_1 y_2 \cdots y_n}.$$

记 $A = y_1 y_2 \cdots y_n$, 则可得

$$du = \sum_{k=1}^n \left(1 - \frac{2}{Ay_k} \right) dy_k.$$

令 $\frac{\partial u}{\partial y_k} = 0$ 得方程组

$$1 - \frac{2}{Ay_k} = 0 \quad (k = 1, 2, \dots, n).$$

解之得静止点 $P_0(y_1, y_2, \dots, y_n)$, 其中

$$y_1 = y_2 = \cdots = y_n = 2^{\frac{1}{n+1}} = y_0.$$

在点 P_0 , 有

$$d^2u \Big|_{P=P_0} = \frac{2}{A} \sum_{k=1}^n \frac{1}{y_k^2} dy_k^2 + \frac{2}{Ay_k^2} \left(\sum_{k=1}^n dy_k \right)^2 \Big|_{P=P_0}$$

$$= \frac{1}{y_0} \left[\sum_{k=1}^n dy_k^2 + \left(\sum_{k=1}^n dy_k \right)^2 \right] \geq 0$$

(当 $\sum_{k=1}^n dy_k^2 \neq 0$ 时),

故函数 u 在 P_0 点取得极小值, 也即在

$$x_1 = y_1 = 2^{\frac{1}{n+1}},$$

$$x_2 = y_2 x_1 = 2^{\frac{2}{n+1}},$$

.....

$$x_k = y_k x_{k-1} = 2^{\frac{k}{n+1}},$$

.....

$$x_n = y_n x_{n-1} = 2^{\frac{n}{n+1}}$$

处, 函数 u 取得极小值 $u = (n+1)2^{\frac{1}{n+1}}$.

3650. 惠更斯问题. 在 a 和 b 二正数间插入 n 个数 x_1, x_2, \dots, x_n , 使得分数

$$u = \frac{x_1 x_2 \cdots x_n}{(a+x_1)(x_1+x_2)\cdots(x_n+b)}$$

的值是最大.

解 记 $w = \frac{1}{u} = (a+x_1)\left(1+\frac{x_2}{x_1}\right)\left(1+\frac{x_3}{x_2}\right)\cdots\left(1+\frac{b}{x_n}\right)$.

设 $y_1 = \frac{x_2}{x_1}, y_2 = \frac{x_3}{x_2}, \dots, y_n = \frac{b}{x_n}$, 并记

$A = y_1 y_2 \cdots y_n$, 则有

$$x_1 = \frac{b}{y_1 y_2 \cdots y_n} = \frac{b}{A},$$

$$w = \left(a + \frac{b}{A}\right) (1 + y_1)(1 + y_2) \cdots (1 + y_n).$$

又记 $m = a + \frac{b}{A}$, 则有

$$\begin{aligned} dw &= \sum_{k=1}^n \frac{w}{1+y_k} dy_k - \frac{wb}{mA} \sum_{k=1}^n \frac{dy_k}{y_k} \\ &= w \sum_{k=1}^n \left(\frac{y_k}{1+y_k} - \frac{b}{mA} \right) \frac{dy_k}{y_k}. \end{aligned}$$

令 $\frac{\partial w}{\partial y_k} = 0$ 得方程组

$$\frac{y_k}{1+y_k} = \frac{b}{mA} \quad (k=1, 2, \dots, n).$$

解之得静止点 $P_0(y_1, y_2, \dots, y_n)$, 其中

$$y_1 = y_2 = \cdots = y_n = \left(\frac{b}{a}\right)^{\frac{1}{n+1}} = y_0.$$

在点 P_0 , 有

$$\begin{aligned} d^2u \Big|_{P=P_0} &= w \sum_{k=1}^n d \left(\frac{y_k}{1+y_k} - \frac{b}{mA} \right) \frac{dy_k}{y_k} \Big|_{P=P_0} \\ &= w \sum_{k=1}^n d \left(\frac{y_k}{1+y_k} \right) \left(\frac{dy_k}{y_0} \right) \Big|_{P=P_0} \\ &\quad - w \sum_{k=1}^n \frac{dy_k}{y_0} \left[d \left(\frac{1}{1 + \frac{a}{b}A} \right) \Big|_{P=P_0} \right] \end{aligned}$$

$$\begin{aligned}
&= \frac{w(P_0)}{y_0(1+y_0)^2} \sum_{k=1}^n dy_k^2 + \frac{w(P_0)}{y_0 \left(1 + \frac{a}{b} A\right)_{P=P_0}^2} \\
&\quad \cdot \sum_{k=1}^n \left[dy_k \left(\sum_{k=1}^n \frac{aA}{by_k} dy_k \right) \right]_{P=P_0} \\
&= \frac{w(P_0)}{y_0(1+y_0)^2} \left[\sum_{k=1}^n dy_k^2 + \left(\sum_{k=1}^n dy_k \right)^2 \right] \\
&\geq 0 \quad \left(\text{当 } \sum_{k=1}^n dy_k^2 \neq 0 \text{ 时} \right),
\end{aligned}$$

故函数 w 在点 P_0 取得极小值，从而函数 u 在

$$\begin{cases}
x_1 = \frac{b}{A} = \frac{b}{y_0^n} = \frac{b}{a} \cdot a y_0^{-n} = a y_0^{n+1} \cdot y_0^{-n} = a y_0, \\
x_2 = x_1 y_1 = a y_0^2, \\
x_3 = x_2 y_2 = a y_0^3, \\
\cdots \cdots \cdots \\
x_n = \frac{b}{y_n} = \frac{b}{a} a y_0^{-1} = a y_0^{n+1} y_0^{-1} = a y_0^n,
\end{cases}$$

即数 $a, x_1, x_2, \dots, x_n, b$ 构成有公比 $y_0 = \left(\frac{b}{a}\right)^{\frac{1}{n+1}}$ 的几何级数时，其值最大，并且 u 的最大值为

$$u = \frac{1}{a(1+y_0)^{n+1}} = \left(a^{\frac{1}{n+1}} + b^{\frac{1}{n+1}} \right)^{-(n+1)}.$$

求变量 x 和 y 的隐函数 z 的极值：

3651. $x^2 + y^2 + z^2 - 2x + 2y - 4z - 10 = 0$.

解 微分得

$$(x-1)dx+(y+1)dy+(z-2)dz=0.$$

显见,当 $x=1, y=-1$ 时 $dz=0$. 代入原方程可解得 $z=6$ 及 $z=-2$. 又 $z=2$ 时为不可微的. 为判断极值, 求二阶微分, 得

$$dx^2+dy^2+(z-2)d^2z+dz^2=0.$$

以 $x=1, y=-1, z=6$ 代入, 并考虑 $dz=0$, 得

$$d^2z=-\frac{1}{4}(dx^2+dy^2)<0 \quad (\text{当 } dx^2+dy^2 \neq 0 \text{ 时}),$$

故当 $x=1, y=-1$ 时, 隐函数 z 取得极大值 $z=6$. 同法可判断得: 当 $x=1, y=-1$ 时, 隐函数 z 也取得极小值, 且其值为 $z=-2$.

不难看出, $z=2$ 是球的切面平行于 Oz 轴的地方, 因此函数 z 不取得极值.

3652. $x^2+y^2+z^2-xz-yz+2x+2y+2z-2=0.$

解 微分一次, 得

$$(2x-z+2)dx+(2y-z+2)dy+(2z-x-y+2)dz=0.$$

解方程组

$$\begin{cases} 2x-z+2=0, \\ 2y-z+2=0, \\ x^2+y^2+z^2-xz-yz+2x+2y+2z-2=0 \end{cases}$$

得 $x_1=y_1=-(3+\sqrt{6}), z_1=-(4+2\sqrt{6})$;

$x_2=y_2=-(3-\sqrt{6}), z_2=2\sqrt{6}-4.$

再微分一次, 并注意到 $dz=0$, 即得

$$2dx^2 + 2dy^2 + (2z - x - y + 2)dz = 0.$$

在点 (x_1, y_1, z_1) , $d^2z = \frac{1}{\sqrt{6}}(dx^2 + dz^2) > 0$, 故当 $x = y = -(3 + \sqrt{6})$ 时, 取得极小值 $z = -(4 + 2\sqrt{6})$. 同法可知, 当 $x = y = -(3 - \sqrt{6})$ 时, 取得极大值 $z = 2\sqrt{6} - 4$.

对于 dz 的系数 $2z - x - y + 2 = 0$ 时代表的情况, 与上题类似也不取得极值.

3653. $(x^2 + y^2 + z^2)^2 = a^2(x^2 + y^2 - z^2)$.

解 微分一次, 得

$$\begin{aligned} 2(x^2 + y^2 + z^2)(xdx + ydy + zdz) \\ = a^2(xdx + ydy - zdz). \end{aligned}$$

令 $dz = 0$, 得方程

$$[2(x^2 + y^2 + z^2) - a^2](xdx + ydy) = 0.$$

解之, 得 $x = y = 0$ 及 $x^2 + y^2 + z^2 = \frac{a^2}{2}$.

以 $x = y = 0$ 代入原方程, 解得 $z = 0$. 这是隐函数的一个奇点. 把原式看作 z^2 的一个方程, 舍去增根, 可解出

$$z^2 = -(a^2 + x^2 + y^2) + \sqrt{a^4 + 3a^2(x^2 + y^2)},$$

显然 z 有正负两支在 $(0, 0, 0)$ 点相交. 因此, 不认为 z 在 $(0, 0, 0)$ 点取得极值.

以 $x^2 + y^2 + z^2 = \frac{a^2}{2}$ 代入原方程, 解得

$$x^2 + y^2 = \frac{3}{8}a^2, \quad z^2 = \frac{a^2}{8}.$$

为考虑极值，将一次微分式改写为

$$\begin{aligned} & [2(x^2 + y^2 + z^2) - a^2](x dx + y dy) + \\ & [2(x^2 + y^2 + z^2) + a^2]z dz = 0. \end{aligned}$$

将上式再微分一次，注意到 $dz=0$ 及 $x^2 + y^2 + z^2 = \frac{a^2}{2}$ ，即得

$$a^2 z d^2 z = -2(x dx + y dy)^2,$$

故当 $x^2 + y^2 = \frac{3}{8} a^2$ ， $z = \frac{a}{2\sqrt{2}}$ 时， $d^2 z \leq 0$ ，函

数 z 取得弱极大值 $z = \frac{a}{2\sqrt{2}}$ ；当 $x^2 + y^2 = \frac{3}{8} a^2$ ，

$z = -\frac{a}{2\sqrt{2}}$ 时， $d^2 z \geq 0$ ，函数 z 取得弱极小值 $z =$

$$-\frac{a}{2\sqrt{2}}.$$

求下列函数的条件极值点：

3654. $z = xy$ ，若 $x + y = 1$ 。

解 设 $F(x, y) = xy + \lambda(x + y - 1)$ 。解方程组

$$\begin{cases} \frac{\partial F}{\partial x} = y + \lambda = 0, \\ \frac{\partial F}{\partial y} = x + \lambda = 0, \\ x + y = 1 \end{cases}$$

得 $x = y = -\lambda = \frac{1}{2}$ ， $z = \frac{1}{4}$ 。由于当 $x \rightarrow \pm\infty$ 时， $y \rightarrow \mp$

∞ ，故 $z = xy \rightarrow -\infty$ 。从而得知：点 $x = \frac{1}{2}$ ， $y = \frac{1}{2}$

为条件极值点，且 $z = \frac{1}{4}$ 为极大值。

如将 $z = xy$ 改写为 $z = y(1-y)$ ，则成为普通极值。易知极大值点为 $y = \frac{1}{2}$ ，从而 $x = 1 - \frac{1}{2} = \frac{1}{2}$ ，

$$z = \frac{1}{4}.$$

3655. $z = \frac{x}{a} + \frac{y}{b}$ ，若 $x^2 + y^2 = 1$ 。

解 设 $F(x, y) = \frac{x}{a} + \frac{y}{b} + \lambda(x^2 + y^2 - 1)$ ，解方程组

$$\begin{cases} \frac{\partial F}{\partial x} = \frac{1}{a} + 2\lambda x = 0, \\ \frac{\partial F}{\partial y} = \frac{1}{b} + 2\lambda y = 0, \\ x^2 + y^2 = 1 \end{cases}$$

可得

$$\lambda = \pm \frac{\sqrt{a^2 + b^2}}{2|ab|}, \quad x = \mp \frac{b\varepsilon}{\sqrt{a^2 + b^2}},$$

$$y = \mp \frac{a\varepsilon}{\sqrt{a^2 + b^2}},$$

其中 $\varepsilon = \operatorname{sgn} ab \neq 0$ 。相应地， $z = \mp \frac{\sqrt{a^2 + b^2}}{|ab|}$ 。

由于函数 z 在闭圆周 $x^2 + y^2 = 1$ 上连续且不为常数，故必取得最大值和最小值并且最大值与最小值

不相等. 这里可疑点仅两个.

因此, 当 $x = -\frac{b\varepsilon}{\sqrt{a^2+b^2}}, y = -\frac{a\varepsilon}{\sqrt{a^2+b^2}}$ 时, 函数

值 $z = -\frac{\sqrt{a^2+b^2}}{|ab|}$ 必为最小值, 从而是极小值; 当

$x = \frac{b\varepsilon}{\sqrt{a^2+b^2}}, y = \frac{a\varepsilon}{\sqrt{a^2+b^2}}$ 时, $z = \frac{\sqrt{a^2+b^2}}{|ab|}$ 为最

大值, 从而是极大值.

3656. $z = x^2 + y^2$, 若 $\frac{x}{a} + \frac{y}{b} = 1$.

解 设 $F(x, y) = x^2 + y^2 + \lambda \left(\frac{x}{a} + \frac{y}{b} - 1 \right)$. 解方程组

$$\begin{cases} \frac{\partial F}{\partial x} = 2x + \frac{1}{a}\lambda = 0, \\ \frac{\partial F}{\partial y} = 2y + \frac{1}{b}\lambda = 0, \\ \frac{x}{a} + \frac{y}{b} = 1 \end{cases}$$

可得

$$\lambda = -\frac{2a^2b^2}{a^2+b^2}, \quad x = \frac{ab^2}{a^2+b^2}, \quad y = \frac{a^2b}{a^2+b^2}.$$

由于当 $x \rightarrow \infty, y \rightarrow \infty$ 时, $z \rightarrow +\infty$, 故函数 z 必在有限处取得最小值. 这里可疑点仅一个. 因此, 当

$x = \frac{ab^2}{a^2+b^2}, y = \frac{a^2b}{a^2+b^2}$ 时, 函数 z 取得极小值

$$z = \frac{a^2 b^2}{a^2 + b^2}.$$

注 如果用二阶微分判别, 则易从

$$d^2 z = 2(dx^2 + dy^2) > 0$$

(不论 dx, dy 之间有何约束条件, 此式恒成立) 可

知 $z = \frac{a^2 b^2}{a^2 + b^2}$ 为极小值.

3657. $z = Ax^2 + 2Bxy + Cy^2$, 若 $x^2 + y^2 = 1$.

解 设 $F(x, y) = Ax^2 + 2Bxy + Cy^2 - \lambda(x^2 + y^2 - 1)$. 解方程组

$$\begin{cases} \frac{\partial F}{\partial x} = 2[(A - \lambda)x + By] = 0, & (1) \\ \frac{\partial F}{\partial y} = 2[Bx + (C - \lambda)y] = 0, & (2) \\ x^2 + y^2 = 1. & (3) \end{cases}$$

由 $x^2 + y^2 = 1$ 知 x, y 不全为零, 故 λ 必须满足方程

$$\begin{vmatrix} A - \lambda & B \\ B & C - \lambda \end{vmatrix} = \lambda^2 - (A + C)\lambda + (AC - B^2) = 0. \quad (4)$$

当 $(A - C)^2 + 4B^2 = 0$ 时, 所研究的函数为常数; 当 $(A - C)^2 + 4B^2 \neq 0$ 时, 方程 (4) 有两个不等的实根, 记为 λ_1 和 λ_2 ($\lambda_1 > \lambda_2$). 由方程组 (1)、(2)、(3) 可解出

$$x_{1,2} = \frac{\pm(\lambda_1 - C)}{\sqrt{B^2 + (\lambda_1 - C)^2}}, y_{1,2} = \frac{\pm(\lambda_1 - A)}{\sqrt{B^2 + (\lambda_1 - A)^2}},$$

$$x_{3,4} = \frac{\pm(\lambda_2 - C)}{\sqrt{B^2 + (\lambda_2 - C)^2}}, y_{3,4} = \frac{\pm(\lambda_2 - A)}{\sqrt{B^2 + (\lambda_2 - A)^2}}.$$

相应地，有

$$\begin{aligned} z(x_1, y_1) &= Ax_1^2 + 2Bx_1y_1 + Cy_1^2 \\ &= (Ax_1 + By_1)x_1 + (Bx_1 + Cy_1)y_1. \end{aligned}$$

由 (1)、(2) 可解得

$$Ax_1 + By_1 = \lambda_1 x_1, \quad Bx_1 + Cy_1 = \lambda_1 y_1,$$

故得

$$z(x_1, y_1) = \lambda_1 x_1^2 + \lambda_1 y_1^2 = \lambda_1 (x_1^2 + y_1^2) = \lambda_1.$$

同理可得

$$z(x_2, y_2) = \lambda_1, \quad z(x_3, y_3) = z(x_4, y_4) = \lambda_2.$$

由于函数 z 在单位球面上连续且不为常数，故必取得最大值和最小值并且最大值和最小值不相等。这里可疑点仅四个 (x_i, y_i) ($i=1, 2, 3, 4$)，而且 $z(x_1, y_1) = z(x_2, y_2) = \lambda_1$ ， $z(x_3, y_3) = z(x_4, y_4) = \lambda_2$ 。于是，当 $x = x_{1,2}$ ， $y = y_{1,2}$ 时，函数 z 取得最大值 $z = \lambda_1$ ，因而也是极大值；当 $x = x_{3,4}$ ， $y = y_{3,4}$ 时，函数 z 取得最小值 $z = \lambda_2$ ，因而也是极小值。

3658. $z = \cos^2 x + \cos^2 y$ ，若 $x - y = \frac{\pi}{4}$ 。

解 设 $F(x, y) = \cos^2 x + \cos^2 y + \lambda(x - y - \frac{\pi}{4})$ 。

解方程组

$$\begin{cases} \frac{\partial F}{\partial x} = -\sin 2x + \lambda = 0, \\ \frac{\partial F}{\partial y} = -\sin 2y - \lambda = 0, \\ x - y = \frac{\pi}{4} \end{cases}$$

可得

$$x_k = \frac{\pi}{8} + \frac{k\pi}{2}, \quad y_k = -\frac{\pi}{8} + \frac{k\pi}{2} \quad (k=0, \pm 1, \pm 2, \dots).$$

相应地, 当 k 为偶数时, $z = 1 + \frac{1}{\sqrt{2}}$; 当 k 为奇数时, $z = 1 - \frac{1}{\sqrt{2}}$.

由于所给连续函数 z 必在任意有限区域内取得最大值和最小值, 而且 z 又是关于 x, y 的周期(周期为 π)函数, 故当 k 为偶数时, 函数 z 在点 (x_k, y_k) 取得最大值 $z = 1 + \frac{1}{\sqrt{2}}$, 从而是极大值; 当 k 为奇数时, 函数 z 在点 (x_k, y_k) 取得最小值 $z = 1 - \frac{1}{\sqrt{2}}$, 从而是极小值.

3659. $u = x - 2y + 2z$, 若 $x^2 + y^2 + z^2 = 1$.

解 设 $F(x, y, z) = x - 2y + 2z + \lambda(x^2 + y^2 + z^2 - 1)$.

解方程组

$$\begin{cases} \frac{\partial F}{\partial x} = 1 + 2\lambda x = 0, \\ \frac{\partial F}{\partial y} = -2 + 2\lambda y = 0, \\ \frac{\partial F}{\partial z} = 2 + 2\lambda z = 0, \\ x^2 + y^2 + z^2 = 1 \end{cases}$$

可得

$$x = \pm \frac{1}{3}, \quad y = \mp \frac{2}{3}, \quad z = \pm \frac{2}{3}.$$

相应地, $u = \pm 3$.

由于所给函数在闭球面上连续且不为常数, 故必取得最大值及最小值并且最大值与最小值不相等. 这里可疑点仅两个, 于是, 当 $x = \frac{1}{3}$, $y = -\frac{2}{3}$, $z = \frac{2}{3}$ 时, 函数 u 取得最大值 $u = 3$, 因而也是极大值; 当 $x = -\frac{1}{3}$, $y = \frac{2}{3}$, $z = -\frac{2}{3}$ 时, 函数 u 取得最小值 $u = -3$, 因而也是极小值.

3660. $u = x^m y^n z^p$, 若 $x + y + z = a$ ($m > 0, n > 0, p > 0, a > 0$)*).

解 设 $w = \ln u = m \ln x + n \ln y + p \ln z$.

$$F(x, y, z) = w - \frac{1}{\lambda}(x + y + z - a).$$

解方程组

$$\begin{cases} \frac{\partial F}{\partial x} = \frac{m}{x} - \frac{1}{\lambda} = 0, \\ \frac{\partial F}{\partial y} = \frac{n}{y} - \frac{1}{\lambda} = 0, \\ \frac{\partial F}{\partial z} = \frac{p}{z} - \frac{1}{\lambda} = 0, \\ x + y + z = a \end{cases}$$

*) 编者注: 应加上条件 $x > 0, y > 0, z > 0$.

可得

$$x = \frac{am}{m+n+p}, \quad y = \frac{an}{m+n+p}, \quad z = \frac{ap}{m+n+p}.$$

$$\text{相应地, } u = \frac{a^{m+n+p} m^m n^n p^p}{(m+n+p)^{m+n+p}}.$$

连续函数 w 定义在平面 $x+y+z=a$ 于第一卦限内的部分, 边界由三条直线

$$\begin{cases} x+y=a, & \begin{cases} y+z=a, \\ x=0, \end{cases} \\ z=0, & \\ \begin{cases} z+x=a, \\ y=0 \end{cases} \end{cases}$$

组成. 当点 P 趋于边界上的点时, 显然有 $w \rightarrow -\infty$. 因此, 函数 w 在区域内取得最大值. 由于可疑点仅

$$\text{一个, 故当 } x = \frac{am}{m+n+p}, \quad y = \frac{an}{m+n+p}$$

$$z = \frac{ap}{m+n+p} \text{ 时, 函数 } u \text{ 取得最大值}$$

$$u = \frac{a^{m+n+p} m^m n^n p^p}{(m+n+p)^{m+n+p}}, \text{ 因而也是极大值.}$$

$$3661. \quad u = x^2 + y^2 + z^2, \text{ 若 } \frac{x^2}{a^2} + \frac{y^2}{b^2} + \frac{z^2}{c^2} = 1 \quad (a > b > c > 0).$$

$$\text{解 设 } F(x, y, z) = x^2 + y^2 + z^2 + \lambda \left(\frac{x^2}{a^2} + \frac{y^2}{b^2} + \frac{z^2}{c^2} \right.$$

$\left. - 1 \right)$. 解方程组

$$\begin{cases} \frac{\partial F}{\partial x} = 2x\left(1 + \frac{\lambda}{a^2}\right) = 0, \\ \frac{\partial F}{\partial y} = 2y\left(1 + \frac{\lambda}{b^2}\right) = 0, \\ \frac{\partial F}{\partial z} = 2z\left(1 + \frac{\lambda}{c^2}\right) = 0, \\ \frac{x^2}{a^2} + \frac{y^2}{b^2} + \frac{z^2}{c^2} = 1 \end{cases}$$

可得

$$x = \pm a, y = z = 0; \quad x = z = 0, y = \pm b;$$

$$x = y = 0, z = \pm c.$$

相应地, 有

$u(\pm a, 0, 0) = a^2$, $u(0, \pm b, 0) = b^2$, $u(0, 0, \pm c) = c^2$. 由于 $a > b > c > 0$, 故连续函数 u 在点 $(\pm a, 0, 0)$ 取得最大值 a^2 , 因而也是极大值; 在点 $(0, 0, \pm c)$ 取得最小值 c^2 , 因而也是极小值.

在点 $(0, \pm b, 0)$ 处, 对应的 $\lambda = -b^2$, 且

$$\begin{aligned} d^2F &= 2\left(1 + \frac{\lambda}{a^2}\right) dx^2 + 2\left(1 + \frac{\lambda}{b^2}\right) dy^2 \\ &\quad + 2\left(1 + \frac{\lambda}{c^2}\right) dz^2 \\ &= 2\left(1 - \frac{b^2}{a^2}\right) dx^2 + 2\left(1 - \frac{b^2}{c^2}\right) dz^2. \end{aligned}$$

把 x, z 当自变量, y 看成由条件 $\frac{x^2}{a^2} + \frac{y^2}{b^2} + \frac{z^2}{c^2} = 1$ 所确定的 x 和 z 的函数. 在点 $(0, \pm b, 0)$, 有 $d^2u = d^2F$,

而 $1 - \frac{b^2}{a^2} > 0$, $1 - \frac{b^2}{c^2} < 0$. 因此, d^2u 的符号不定,

从而函数 u 在点 $(0, \pm b, 0)$ 不取得极值.

3662. $u = xy^2z^3$, 若 $x + 2y + 3z = a$ ($x > 0, y > 0, z > 0, a > 0$).

解 设 $w = \ln u = \ln x + 2 \ln y + 3 \ln z$,

$$F(x, y, z) = w - \frac{1}{\lambda}(x + 2y + 3z - a).$$

解方程组

$$\begin{cases} \frac{\partial F}{\partial x} = \frac{1}{x} - \frac{1}{\lambda} = 0, \\ \frac{\partial F}{\partial y} = \frac{2}{y} - \frac{2}{\lambda} = 0, \\ \frac{\partial F}{\partial z} = \frac{3}{z} - \frac{3}{\lambda} = 0, \\ x + 2y + 3z = a \end{cases}$$

可得

$$x = y = z = \frac{a}{6}.$$

类似3660题的讨论可知, 函数 u 当 $x = y = z = \frac{a}{6}$ 时取

得极大值 $u = \left(\frac{a}{6}\right)^6$.

3663. $u = xyz$, 若 $x^2 + y^2 + z^2 = 1$, $x + y + z = 0$.

解 设 $F(x, y, z) = xyz + \lambda(x^2 + y^2 + z^2 - 1) + \mu(x + y + z)$. 解方程组

$$\left\{ \begin{array}{l} \frac{\partial F}{\partial x} = yz + 2\lambda x + \mu = 0, \\ \frac{\partial F}{\partial y} = xz + 2\lambda y + \mu = 0, \\ \frac{\partial F}{\partial z} = xy + 2\lambda z + \mu = 0, \\ x^2 + y^2 + z^2 = 1, \\ x + y + z = 0. \end{array} \right. \quad (1)$$

$$(2)$$

$$(3)$$

$$(4)$$

$$(5)$$

(1) - (2), (2) - (3), 得

$$\left\{ \begin{array}{l} (x-y)(2\lambda-z) = 0, \\ (y-z)(2\lambda-x) = 0. \end{array} \right. \quad (6)$$

$$(7)$$

由(6), 若 $x-y=0$, 代入(5)得 $z=-2x$. 再代入

(4), 解得静止点 $P_1\left(\frac{1}{\sqrt{6}}, \frac{1}{\sqrt{6}}, -\frac{2}{\sqrt{6}}\right)$ 和

$$P_2\left(-\frac{1}{\sqrt{6}}, -\frac{1}{\sqrt{6}}, \frac{2}{\sqrt{6}}\right).$$

如果 $x-y \neq 0$, 则 $z=2\lambda$. 由(7), 若 $y-z=0$,

类似上面解法可得静止点 $P_3\left(-\frac{2}{\sqrt{6}}, \frac{1}{\sqrt{6}}, \frac{1}{\sqrt{6}}\right)$

和 $P_4\left(\frac{2}{\sqrt{6}}, -\frac{1}{\sqrt{6}}, -\frac{1}{\sqrt{6}}\right)$; 若 $y-z \neq 0$, 则

$x=2\lambda$, 故 $x=z$, 类似上面解法又可得静止点 $P_5\left(\frac{1}{\sqrt{6}},$

$-\frac{2}{\sqrt{6}}, \frac{1}{\sqrt{6}}\right)$ 和 $P_6\left(-\frac{1}{\sqrt{6}}, \frac{2}{\sqrt{6}}, -\frac{1}{\sqrt{6}}\right)$.

相应地, 有

$$u(P_1) = u(P_3) = u(P_5) = -\frac{1}{3\sqrt{6}},$$

$$u(P_2) = u(P_4) = u(P_6) = \frac{1}{3\sqrt{6}}.$$

类似前面各题的讨论可知, 函数 u 在点 P_1, P_3 及 P_5

取得极小值 $u = -\frac{1}{3\sqrt{6}}$; 在点 P_2, P_4 及 P_6 取得极

大值 $u = \frac{1}{3\sqrt{6}}$.

3664. $u = \sin x \sin y \sin z$, 若 $x + y + z = \frac{\pi}{2}$

$$(x > 0, y > 0, z > 0).$$

解 由 $x + y + z = \frac{\pi}{2}$ 及 $x > 0, y > 0, z > 0$ 不难得出

$$0 < x < \frac{\pi}{2}, \quad 0 < y < \frac{\pi}{2}, \quad 0 < z < \frac{\pi}{2}.$$

设 $w = \ln u = \ln \sin x + \ln \sin y + \ln \sin z$,

$$F(x, y, z) = w + \lambda \left(x + y + z - \frac{\pi}{2} \right).$$

解方程组

$$\begin{cases} \frac{\partial F}{\partial x} = \operatorname{ctg} x + \lambda = 0, \\ \frac{\partial F}{\partial y} = \operatorname{ctg} y + \lambda = 0, \\ \frac{\partial F}{\partial z} = \operatorname{ctg} z + \lambda = 0, \\ x + y + z = \frac{\pi}{2} \end{cases}$$

并注意到点 $P(x, y, z)$ 在第一卦限, 即得静止点 P_0

$$\left(\frac{\pi}{6}, \frac{\pi}{6}, \frac{\pi}{6}\right).$$

类似3660题的讨论, 当点 (x, y, z) 趋于平面 $x+y+z=\frac{\pi}{2}$ 在第一卦限部分的边界时, $u \rightarrow 0$; 而在边界内部 $u > 0$. 因此, 函数 u 在边界内部取得最大值, 故在点 P_0 取得极大值 $u(P_0) = \frac{1}{8}$.

3665. $u = \frac{x^2}{a^2} + \frac{y^2}{b^2} + \frac{z^2}{c^2}$, 若 $x^2 + y^2 + z^2 = 1$, $x \cos \alpha + y \cos \beta + z \cos \gamma = 0$ ($a > b > c > 0$, $\cos^2 \alpha + \cos^2 \beta + \cos^2 \gamma = 1$).

解 设 $F(x, y, z) = \frac{x^2}{a^2} + \frac{y^2}{b^2} + \frac{z^2}{c^2} - \lambda(x^2 + y^2 + z^2 - 1) + \mu(x \cos \alpha + y \cos \beta + z \cos \gamma)$.

解方程组

$$\begin{cases} \frac{\partial F}{\partial x} = 2\left(\frac{1}{a^2} - \lambda\right)x + \mu \cos \alpha = 0, & (1) \end{cases}$$

$$\begin{cases} \frac{\partial F}{\partial y} = 2\left(\frac{1}{b^2} - \lambda\right)y + \mu \cos \beta = 0, & (2) \end{cases}$$

$$\begin{cases} \frac{\partial F}{\partial z} = 2\left(\frac{1}{c^2} - \lambda\right)z + \mu \cos \gamma = 0, & (3) \end{cases}$$

$$\begin{cases} x^2 + y^2 + z^2 = 1, & (4) \end{cases}$$

$$\begin{cases} x \cos \alpha + y \cos \beta + z \cos \gamma = 0, & (5) \end{cases}$$

$$\begin{cases} \cos^2 \alpha + \cos^2 \beta + \cos^2 \gamma = 1. & (6) \end{cases}$$

将(1)、(2)、(3)三式分别乘以 x, y, z , 然后相加, 并注意到(4)、(5)两式, 即得

$$\lambda = \frac{x^2}{a^2} + \frac{y^2}{b^2} + \frac{z^2}{c^2} = u(x, y, z). \quad (7)$$

再将(1)、(2)、(3)三式分别乘以 $\cos\alpha, \cos\beta, \cos\gamma$, 然后相加, 并注意到(5)、(6)两式, 即得

$$\mu = -2\left(\frac{x\cos\alpha}{a^2} + \frac{y\cos\beta}{b^2} + \frac{z\cos\gamma}{c^2}\right). \quad (8)$$

将(8)式代入(1)、(2)、(3), 得

$$\begin{cases} \left(\frac{\sin^2\alpha}{a^2} - \lambda\right)x - \frac{\cos\alpha\cos\beta}{b^2}y - \frac{\cos\alpha\cos\gamma}{c^2}z = 0, \\ -\frac{\cos\alpha\cos\beta}{a^2}x + \left(\frac{\sin^2\beta}{b^2} - \lambda\right)y - \frac{\cos\beta\cos\gamma}{c^2}z = 0, \\ -\frac{\cos\alpha\cos\gamma}{a^2}x - \frac{\cos\beta\cos\gamma}{b^2}y + \left(\frac{\sin^2\gamma}{c^2} - \lambda\right)z = 0. \end{cases} \quad (9)$$

要 $\frac{x}{a^2}, \frac{y}{b^2}, \frac{z}{c^2}$ 为方程组(9)的非零解, 必须有

$$\begin{vmatrix} \sin^2\alpha - a^2\lambda & -\cos\alpha\cos\beta & -\cos\alpha\cos\gamma \\ -\cos\alpha\cos\beta & \sin^2\beta - b^2\lambda & -\cos\beta\cos\gamma \\ -\cos\alpha\cos\gamma & -\cos\beta\cos\gamma & \sin^2\gamma - c^2\lambda \end{vmatrix} = 0.$$

展开计算可得

$$\lambda \left[\lambda^2 - \left(\frac{\sin^2\alpha}{a^2} + \frac{\sin^2\beta}{b^2} + \frac{\sin^2\gamma}{c^2} \right) \lambda + \left(\frac{\cos^2\alpha}{b^2c^2} + \frac{\cos^2\beta}{c^2a^2} + \frac{\cos^2\gamma}{a^2b^2} \right) \right] = 0. \quad (10)$$

由(7)知 $\lambda \neq 0$, 且不难验证(10)式在消去 λ 后得到

的二次方程有两个不等的实根 $\lambda_1 < \lambda_2$.

固定 $\lambda = \lambda_1$, 代入方程组(9), 可得到关于 (x, y, z) 有一个自由度的一个解系, 再代入方程(4), 可得对应于 $\lambda = \lambda_1$ 的两个静止点 $P_1(x_1, y_1, z_1)$ 和 $P_2(x_2, y_2, z_2)$. 由(7)知, 对应的 $u(P_1) = u(P_2) = \lambda_1$. 同理可求得对应于 $\lambda = \lambda_2$ 的两个静止点 $P_3(x_3, y_3, z_3)$ 和 $P_4(x_4, y_4, z_4)$, 且有 $u(P_3) = u(P_4) = \lambda_2$.

P_1, P_2, P_3, P_4 为满足方程组(1)~(5)的一切解所对应的点. 类似前面各题的讨论可知, 函数 u 在点 P_1 及 P_2 取得极小值 λ_1 , 而在点 P_3 及 P_4 取得极大值 λ_2 .

$$3666^{\dagger} \quad u = (x - \xi)^2 + (y - \eta)^2 + (z - \zeta)^2, \text{ 若 } Ax + By + Cz = 0, x^2 + y^2 + z^2 = R^2, \frac{\xi}{\cos \alpha} = \frac{\eta}{\cos \beta} = \frac{\zeta}{\cos \gamma},$$

其中 $\cos^2 \alpha + \cos^2 \beta + \cos^2 \gamma = 1$.

解 设 $F(x, y, z) = (x - \xi)^2 + (y - \eta)^2 + (z - \zeta)^2 + \lambda(Ax + By + Cz) + \mu(x^2 + y^2 + z^2 - R^2)$.

记 $\xi = \rho \cos \alpha, \eta = \rho \cos \beta, \zeta = \rho \cos \gamma, \rho = \sqrt{\xi^2 + \eta^2 + \zeta^2}$.

解方程组

$$\begin{cases} \frac{\partial F}{\partial x} = 2(x - \rho \cos \alpha) + \lambda A + 2\mu x = 0, & (1) \\ \frac{\partial F}{\partial y} = 2(y - \rho \cos \beta) + \lambda B + 2\mu y = 0, & (2) \\ \frac{\partial F}{\partial z} = 2(z - \rho \cos \gamma) + \lambda C + 2\mu z = 0, & (3) \\ x^2 + y^2 + z^2 = R^2, & (4) \\ Ax + By + Cz = 0, & (5) \\ \cos^2 \alpha + \cos^2 \beta + \cos^2 \gamma = 1. & (6) \end{cases}$$

将(1)、(2)、(3)三式分别乘以 A 、 B 、 C ，然后相加，并注意到(5)式，即得

$$-2\rho(A\cos\alpha + B\cos\beta + C\cos\gamma) + \lambda(A^2 + B^2 + C^2) = 0,$$

$$\lambda = \frac{2\rho(A\cos\alpha + B\cos\beta + C\cos\gamma)}{A^2 + B^2 + C^2}. \quad (7)$$

再将(1)、(2)、(3)三式分别乘以 x 、 y 、 z ，然后相加，并注意到(4)式和(5)式，即得

$$2(1+\mu)R^2 = 2\rho(x\cos\alpha + y\cos\beta + z\cos\gamma). \quad (8)$$

又将(1)、(2)、(3)三式分别乘以 $\cos\alpha$ 、 $\cos\beta$ 、 $\cos\gamma$ ，然后相加，并注意到(6)式，即得

$$\begin{aligned} 2(1+\mu)(x\cos\alpha + y\cos\beta + z\cos\gamma) \\ &= 2\rho - \lambda(A\cos\alpha + B\cos\beta + C\cos\gamma) \\ &= 2\rho \left[1 - \frac{(A\cos\alpha + B\cos\beta + C\cos\gamma)^2}{A^2 + B^2 + C^2} \right]. \end{aligned} \quad (9)$$

由(8)、(9)可得

$$\begin{aligned} (1+\mu)^2 R^2 &= (1+\mu)\rho(x\cos\alpha + y\cos\beta + z\cos\gamma) \\ &= \rho^2 \left[1 - \frac{(A\cos\alpha + B\cos\beta + C\cos\gamma)^2}{A^2 + B^2 + C^2} \right]. \end{aligned}$$

即

$$1+\mu = \pm \frac{\rho}{R} \sqrt{1 - \frac{(A\cos\alpha + B\cos\beta + C\cos\gamma)^2}{A^2 + B^2 + C^2}}. \quad (10)$$

由(1)、(2)、(3)可得

$$\begin{aligned} x &= \frac{2\rho\cos\alpha - \lambda A}{2(1+\mu)}, \quad y = \frac{2\rho\cos\beta - \lambda B}{2(1+\mu)}, \\ z &= \frac{2\rho\cos\gamma - \lambda C}{2(1+\mu)}. \end{aligned}$$

把(7)式和(10)式代入上式, 即可得 $P_1(x_1, y_1, z_1)$ 和 $P_2(x_2, y_2, z_2)$, 其中 P_1 对应于(10)式取正号, 而 P_2 对应于(10)式取负号. 下面求 $u(P_1)$ 和 $u(P_2)$. 由(9)、(10)可得

$$\begin{aligned} & x \cos \alpha + y \cos \beta + z \cos \gamma \\ &= \pm R \sqrt{1 - \frac{(A \cos \alpha + B \cos \beta + C \cos \gamma)^2}{A^2 + B^2 + C^2}}. \end{aligned}$$

于是,

$$\begin{aligned} u(P_1) &= (x_1 - \rho \cos \alpha)^2 + (y_1 - \rho \cos \beta)^2 \\ &\quad + (z_1 - \rho \cos \gamma)^2 \\ &= (x_1^2 + y_1^2 + z_1^2) - 2\rho(x_1 \cos \alpha + y_1 \cos \beta \\ &\quad + z_1 \cos \gamma) + \rho^2 \\ &= R^2 + \rho^2 - 2\rho R \sqrt{1 - \frac{(A \cos \alpha + B \cos \beta + C \cos \gamma)^2}{A^2 + B^2 + C^2}}. \end{aligned}$$

同理可得

$$\begin{aligned} u(P_2) &= R^2 + \rho^2 + 2\rho R \\ &\quad \cdot \sqrt{1 - \frac{(A \cos \alpha + B \cos \beta + C \cos \gamma)^2}{A^2 + B^2 + C^2}}. \end{aligned}$$

类似以前各题的讨论可知: $u(P_2)$ 为极大值, $u(P_1)$ 为极小值.

3667. $u = x_1^2 + x_2^2 + \cdots + x_n^2$, 若 $\frac{x_1}{a_1} + \frac{x_2}{a_2} + \cdots + \frac{x_n}{a_n} = 1$

($a_i > 0$; $i = 1, 2, \dots, n$).

解 设 $F(x_1, x_2, \dots, x_n) = x_1^2 + x_2^2 + \cdots + x_n^2 + \lambda \left(\frac{x_1}{a_1} \right.$

$\left. + \frac{x_2}{a_2} + \cdots + \frac{x_n}{a_n} - 1 \right)$. 解方程组

$$\begin{cases} \frac{\partial F}{\partial x_i} = 2x_i + \frac{\lambda}{a_i} = 0 & (i=1, 2, \dots, n), \\ \sum_{i=1}^n \frac{x_i}{a_i} = 1 \end{cases}$$

可得静止点 $P_0(x_1, x_2, \dots, x_n)$, 其中

$$x_i = \frac{1}{a_i} \left(\sum_{j=1}^n \frac{1}{a_j^2} \right)^{-1} \quad (i=1, 2, \dots, n).$$

由于 $d^2u = d^2F = 2 \sum_{i=1}^n dx_i^2 > 0$ (它不受约束条件的

限制), 故当 $x_i = \frac{1}{a_i} \left(\sum_{j=1}^n \frac{1}{a_j^2} \right)^{-1}$ 时, 函数 u 取得极小值

$$u = \sum_{i=1}^n \left[\frac{1}{a_i} \left(\sum_{j=1}^n \frac{1}{a_j^2} \right)^{-1} \right]^2 = \left(\sum_{i=1}^n \frac{1}{a_i^2} \right)^{-1}.$$

3668. $u = x_1^p + x_2^p + \dots + x_n^p$ ($p > 1$), 若 $x_1 + x_2 + \dots + x_n = a$ ($a > 0$).

解 设 $F(x_1, x_2, \dots, x_n) = x_1^p + x_2^p + \dots + x_n^p + \lambda(x_1 + x_2 + \dots + x_n - a)$. 解方程组

$$\begin{cases} \frac{\partial F}{\partial x_i} = px_i^{p-1} + \lambda = 0 & (i=1, 2, \dots, n), \\ \sum_{i=1}^n x_i = a \end{cases}$$

得 $x_i = \frac{a}{n}$ ($i=1, 2, \dots, n$). 由于

$$\frac{\partial^2 F}{\partial x_i \partial x_j} = \begin{cases} p(p-1)x_i^{p-2}, & i=j, \\ 0 & , i \neq j, \end{cases}$$

故当 $x_i = \frac{a}{n}$ ($i=1, 2, \dots, n$) 时,

$$d^2F = p(p-1) \sum_{i=1}^n \left(\frac{a}{n}\right)^{p-2} dx_i^2 > 0 \quad \left(\text{当 } \sum_{i=1}^n dx_i^2 \neq 0 \text{ 时}\right),$$

它不受约束条件的限制, 故函数 u 取得极小值 $u = \frac{a^p}{n^{p-1}}$.

这里应该指出的是, 对于一般的实数 p , 应限定 $x_i > 0$.

3669. $u = \frac{\alpha_1}{x_1} + \frac{\alpha_2}{x_2} + \dots + \frac{\alpha_n}{x_n}$, 若 $\beta_1 x_1 + \beta_2 x_2 + \dots + \beta_n x_n = 1$ ($\alpha_i > 0, \beta_i > 0; i=1, 2, \dots, n$)*).

解 设 $F(x_1, x_2, \dots, x_n) = \frac{\alpha_1}{x_1} + \frac{\alpha_2}{x_2} + \dots + \frac{\alpha_n}{x_n} + \lambda(\beta_1 x_1 + \beta_2 x_2 + \dots + \beta_n x_n - 1)$.

解方程组

$$\begin{cases} \frac{\partial F}{\partial x_i} = -\frac{\alpha_i}{x_i^2} + \lambda\beta_i = 0 & (i=1, 2, \dots, n), \\ \sum_{i=1}^n \beta_i x_i = 1 \end{cases}$$

得 $x_i = \sqrt{\frac{\alpha_i}{\beta_i}} \left(\sum_{j=1}^n \sqrt{\alpha_j \beta_j}\right)^{-1}$ ($i=1, 2, \dots, n$). 由于

$$d^2F = 2 \sum_{i=1}^n \frac{\alpha_i}{x_i^3} dx_i^2 > 0,$$

* 编者注: 本题应加条件 $x_i > 0$ ($i=1, 2, \dots, n$).

故当 $x_i = \sqrt{\frac{\alpha_i}{\beta_i}} \left(\sum_{i=1}^n \sqrt{\alpha_i \beta_i} \right)^{-1}$ 时, 函数 u 取得极小值

$$u = \left(\sum_{i=1}^n \sqrt{\alpha_i \beta_i} \right)^2.$$

3670. $u = x_1^{\alpha_1} x_2^{\alpha_2} \cdots x_n^{\alpha_n}$, 若 $x_1 + x_2 + \cdots + x_n = a$ ($a > 0$, $\alpha_i > 1$, $i = 1, 2, \dots, n$)^{*}).

解 设 $w = \ln u = \sum_{i=1}^n \alpha_i \ln x_i$,

$$\begin{aligned} F(x_1, x_2, \dots, x_n) &= w - \frac{1}{\lambda} \left(\sum_{i=1}^n x_i - a \right) \\ &= \sum_{i=1}^n \left(\alpha_i \ln x_i - \frac{x_i}{\lambda} \right) + \frac{a}{\lambda}. \end{aligned}$$

解方程组

$$\begin{cases} \frac{\partial F}{\partial x_i} = \frac{\alpha_i}{x_i} - \frac{1}{\lambda} = 0 & (i=1, 2, \dots, n), \\ \sum_{i=1}^n x_i = a \end{cases}$$

得 $x_i = \frac{a \alpha_i}{\alpha_1 + \alpha_2 + \cdots + \alpha_n}$ ($i=1, 2, \dots, n$). 由于

$$d^2 w = - \sum_{i=1}^n \frac{\alpha_i}{x_i^2} dx_i^2 < 0 \quad \left(\text{当 } \sum_{i=1}^n dx_i^2 \neq 0 \text{ 时} \right)$$

不论 dx_i 之间有什么约束条件恒成立, 故函数 w 当

$x_i = \frac{a \alpha_i}{\alpha_1 + \alpha_2 + \cdots + \alpha_n}$ ($i=1, 2, \dots, n$) 时取得极大值,

^{*} 编者注: 本题应加条件 $x_i > 0$ ($i=1, 2, \dots, n$).

即函数 u 当 $x_i = \frac{\alpha \alpha_i}{\alpha_1 + \alpha_2 + \dots + \alpha_n}$ 时取得极大值

$$u = \left(\frac{\alpha}{\alpha_1 + \alpha_2 + \dots + \alpha_n} \right)^{\alpha_1 + \alpha_2 + \dots + \alpha_n} \cdot \alpha_1^{\alpha_1} \alpha_2^{\alpha_2} \dots \alpha_n^{\alpha_n}.$$

3671. 若 $\sum_{i=1}^n x_i^2 = 1$, 求二次型 $u = \sum_{i,j=1}^n a_{ij} x_i x_j$ ($a_{ij} = a_{ji}$) 的极值.

解 设 $F(x_1, x_2, \dots, x_n) = u - \lambda(x_1^2 + x_2^2 + \dots + x_n^2 - 1)$. 解方程组

$$\begin{cases} \frac{1}{2} \frac{\partial F}{\partial x_1} = (a_{11} - \lambda)x_1 + a_{12}x_2 + \dots + a_{1n}x_n = 0, & (1) \\ \frac{1}{2} \frac{\partial F}{\partial x_2} = a_{21}x_1 + (a_{22} - \lambda)x_2 + \dots + a_{2n}x_n = 0, & (2) \\ \dots\dots\dots \\ \frac{1}{2} \frac{\partial F}{\partial x_n} = a_{n1}x_1 + a_{n2}x_2 + \dots + (a_{nn} - \lambda)x_n = 0, & (n) \\ x_1^2 + x_2^2 + \dots + x_n^2 = 1. & (n+1) \end{cases}$$

前 n 个方程要有非零解, 必须矩阵 (a_{ij}) 的特征方程 $|A - \lambda E| = 0$ 有解, 其中 A 为以 a_{ij} 为元素的实对称矩阵, E 为单位矩阵. 由线性代数中关于欧氏空间的理论知, 此特征方程必有 n 个实根, 即有 $\lambda_1 \geq \lambda_2 \geq \dots \geq \lambda_n$ 满足 $|A - \lambda E| = 0$. 对于任一根 λ_k , 代入方程 (1)~(n), 可求得 (x_1, x_2, \dots, x_n) 的一个解空间, 解空间的维数, 等于 λ_k 的重数. 解空间中的单位元素即方程组 (1)~(n+1) 的根. 当 λ_k 是单重根时, 解空

间是一维的, 单位元素只有两个. 当 λ_k 是多重根时, 对应 λ_k 的单位元素就有无穷多个了.

对于 λ_k 的解 (x_1, x_2, \dots, x_n) , 显然满足方程组 (1)~(n+1). 因此, 有 $\sum_{j=1}^n a_{ij}x_j = \lambda_k x_i$ ($i=1, 2, \dots, n$). 从而得

$$\begin{aligned} u(x_1, x_2, \dots, x_n) &= \sum_{i,j=1}^n a_{ij}x_i x_j = \sum_{i=1}^n x_i \left(\sum_{j=1}^n a_{ij}x_j \right) \\ &= \sum_{i=1}^n \lambda_k x_i^2 = \lambda_k \sum_{i=1}^n x_i^2 = \lambda_k. \end{aligned}$$

由于函数 u 在 n 维球面 $x_1^2 + x_2^2 + \dots + x_n^2 = 1$ 上连续, 故必取得最大值和最小值. 于是, 对应于 λ_1 和 λ_n 的解, 分别使函数 u 取得最大值 λ_1 和最小值 λ_n , 因而也是 u 的极大值和极小值, 或是 u 的弱极大值和弱极小值, 视 λ_1 和 λ_n 的重数而定 (多重时为弱极值). 由线性代数中把 d^2F 化标准型的方法, 可证: 对于不等于 λ_1 和 λ_n 的 λ_k , 二次型不取得极值.

3672. 若 $n \geq 1$ 及 $x \geq 0$, $y \geq 0$, 证明不等式

$$\frac{x^n + y^n}{2} \geq \left(\frac{x+y}{2} \right)^n.$$

证 考虑函数 $z = \frac{x^n + y^n}{2}$ 在条件 $x+y=a$ ($a>0, x \geq 0, y \geq 0$) 下的极值问题. 设

$$F(x, y) = \frac{1}{2}(x^n + y^n) + \lambda(x + y - a).$$

解方程组

$$\begin{cases} \frac{\partial F}{\partial x} = \frac{n}{2} x^{n-1} + \lambda = 0, \\ \frac{\partial F}{\partial y} = \frac{n}{2} y^{n-1} + \lambda = 0, \\ x + y = a \end{cases}$$

可得 $x = y = \frac{a}{2}$.

将点 $(\frac{a}{2}, \frac{a}{2})$ 与边界点 $(0, a)$ 、 $(a, 0)$ 的函数值进行比较 (注意到 $n \geq 1$):

$$z(0, a) = z(a, 0) = \frac{a^n}{2} \geq \left(\frac{a}{2}\right)^n = z\left(\frac{a}{2}, \frac{a}{2}\right) \quad (n > 1),$$

即知函数 z 当 $x + y = a$ 时的最小值为 $\left(\frac{a}{2}\right)^n$. 从而有

$$\frac{x^n + y^n}{2} \geq \left(\frac{a}{2}\right)^n$$

(当 $x + y = a$, $x \geq 0$, $y \geq 0$ 时). (1)

下面我们证明

$$\frac{x^n + y^n}{2} \geq \left(\frac{x + y}{2}\right)^n \quad (\text{当 } x \geq 0, y \geq 0 \text{ 时}). \quad (2)$$

当 $x = y = 0$ 时, 不等式(2)显然成立; 当 $x \geq 0$, $y \geq 0$ 且 x, y 不同时为零时, 令 $x + y = a$, 则 $a > 0$. 于是, 由不等式(1)即得

$$\frac{x^n + y^n}{2} \geq \left(\frac{a}{2}\right)^n = \left(\frac{x + y}{2}\right)^n.$$

由此可知, 不等式(2)成立. 证毕.

3673. 证明和尔塞不等式

$$\sum_{i=1}^n a_i x_i \leq \left(\sum_{i=1}^n a_i^k \right)^{\frac{1}{k}} \left(\sum_{i=1}^n x_i^{k'} \right)^{\frac{1}{k'}}$$

($a_i \geq 0, x_i \geq 0, i=1, 2, \dots, n; k > 1, \frac{1}{k} + \frac{1}{k'} = 1$).

证 我们首先证明函数

$$u = \left(\sum_{i=1}^n a_i^k \right)^{\frac{1}{k}} \left(\sum_{i=1}^n x_i^{k'} \right)^{\frac{1}{k'}}$$

在条件 $\sum_{i=1}^n a_i x_i = A$ ($A > 0$) 下的最小值是 A . 为此,

对 n 用数学归纳法.

当 $n=1$ 时, 显然有

$$(a_1^k)^{\frac{1}{k}} (x_1^{k'})^{\frac{1}{k'}} = a_1 x_1 = A.$$

设当 $n=m$ 时, 命题为真, 故对任意 m 个数 $a_1,$

a_2, \dots, a_m ($a_i \geq 0$), 当 $\sum_{i=1}^m a_i x_i = A$ ($x_1 \geq 0, \dots, x_m \geq 0$) 时, 必有

$$A \leq \left(\sum_{i=1}^m a_i^k \right)^{\frac{1}{k}} \left(\sum_{i=1}^m x_i^{k'} \right)^{\frac{1}{k'}}.$$

我们证明当 $n=m+1$ 时命题也真. 设 $\sum_{i=1}^{m+1} a_i x_i = A,$

$u = a \left(\sum_{i=1}^{m+1} x_i^{k'} \right)^{\frac{1}{k'}}$, 其中 $a = \sum_{i=1}^{m+1} a_i^k$, 求 u 的最小

值. 令

$$F(x_1, x_2, \dots, x_{m+1}) = u(x_1, x_2, \dots, x_{m+1}) \\ - \lambda \left(\sum_{i=1}^{m+1} a_i x_i - A \right).$$

解方程组

$$\begin{cases} \frac{\partial F}{\partial x_i} = \frac{a_i^{\frac{1}{k}}}{k'} \left(\sum_{i=1}^{m+1} x_i^{k'} \right)^{\frac{1}{k'}-1} (k' x_i^{k'-1}) - \lambda a_i = 0 \\ \sum_{i=1}^{m+1} a_i x_i = A \end{cases} \quad (i=1, 2, \dots, m+1),$$

可得

$$\frac{x_i^{k'-1}}{a_i} = \frac{\lambda}{a_i^{\frac{1}{k}}} \left(\sum_{i=1}^{m+1} x_i^{k'} \right)^{\frac{1}{k}} = \mu^{k'-1} \quad (i=1, 2, \dots, m+1).$$

(这里引入了记号 μ)，即

$$x_i = (a_i \mu^{k'-1})^{\frac{1}{k'-1}} = a_i^{\frac{1}{k'-1}} \mu = \mu a_i^{k-1},$$

从而有

$$\mu \sum_{i=1}^{m+1} a_i a_i^{k-1} = \mu \sum_{i=1}^{m+1} a_i^k = \mu a = A,$$

$$\mu = \frac{A}{a}.$$

于是，解得满足极值必要条件的唯一解

$$x_i^0 = \frac{A}{a} a_i^{k-1} \quad (i=1, 2, \dots, m+1).$$

对应的函数值为

$$\begin{aligned} u_0 &= u(x_1^0, x_2^0, \dots, x_{m+1}^0) = a^{\frac{1}{k}} \left[\sum_{i=1}^{m+1} \left(\frac{A}{a} a_i^{k-1} \right)^{k'} \right]^{\frac{1}{k'}} \\ &= a^{\frac{1}{k}} \frac{A}{a} \left[\sum_{i=1}^{m+1} a_i^{(k-1)k'} \right]^{\frac{1}{k'}} = a^{\frac{1}{k}-1} A \left(\sum_{i=1}^{m+1} a_i^k \right)^{\frac{1}{k'}} \\ &= A a^{\frac{1}{k}-1} a^{\frac{1}{k'}} = A. \end{aligned}$$

所研究的区域 $\sum_{i=1}^{m+1} a_i x_i = A, x_i \geq 0 (i=1, 2, \dots, m+1)$

是 $m+1$ 维空间中一个 m 维平面在第一卦限的部份，其边界由 $m+1$ 个 $m-1$ 维平面(之一部分)所组成：

$x_i = 0, \sum_{i=1}^{m+1} a_i x_i = A (a_i \geq 0, x_i \geq 0; i=1, 2, \dots,$

$m+1)$ 。在这些边界面上，求

$$u(x_1, x_2, \dots, x_{m+1})$$

$$= u(x_1, x_2, \dots, x_{i-1}, 0, x_{i+1}, \dots, x_{m+1})$$

$$= a^{\frac{1}{k}} \left(\sum_{j=1}^{i-1} x_j^{k'} + \sum_{j=i+1}^{m+1} x_j^{k'} \right)^{\frac{1}{k}}$$

的最小值变为求 m 个变量的最小值。以估计 $x_{m+1} = 0$,

$\sum_{i=1}^m a_i x_i = A$ 的最小值为例。根据归纳法假设，注意到

$$a = \sum_{i=1}^{m+1} a_i^k \geq \sum_{i=1}^m a_i^k, \text{ 即有}$$

$$u(x_1, x_2, \dots, x_m, 0) = a^{\frac{1}{k}} \left(\sum_{i=1}^m x_i^{k'} \right)^{\frac{1}{k}}$$

$$\geq \left(\sum_{i=1}^m a_i^k \right)^{\frac{1}{k}} \cdot \left(\sum_{i=1}^m x_i^{k'} \right)^{\frac{1}{k}} \geq \sum_{i=1}^m a_i x_i = A.$$

因此， u 在边界面上的最小值不小于 A 。由此可知，

u 在区域上的最小值为 $u(x_1^0, x_2^0, \dots, x_{m+1}^0) = A$ ，故命题

当 $n = m+1$ 时为真。于是，由归纳法可知

$$\left(\sum_{i=1}^n a_i^k \right)^{\frac{1}{k}} \left(\sum_{i=1}^n x_i^{k'} \right)^{\frac{1}{k}} \geq A,$$

当 $\sum_{i=1}^n a_i x_i = A, x_i \geq 0 (i=1, 2, \dots, n)$ 时。(1)

下面我们证明和尔塞不等式

$$\sum_{i=1}^n a_i x_i \leq \left(\sum_{i=1}^n a_i^k \right)^{\frac{1}{k}} \left(\sum_{i=1}^n x_i^{k'} \right)^{\frac{1}{k'}} \quad (a_i \geq 0, x_i \geq 0) \quad (2)$$

成立. 事实上, 若 $\sum_{i=1}^n a_i x_i = 0$, 则(2)式显然成立;

若 $\sum_{i=1}^n a_i x_i > 0$, 令 $\sum_{i=1}^n a_i x_i = A$, 则 $A > 0$. 于是, 根

$$\text{据不等式(1)知} \left(\sum_{i=1}^n a_i^k \right)^{\frac{1}{k}} \left(\sum_{i=1}^n x_i^{k'} \right)^{\frac{1}{k'}} \geq A = \sum_{i=1}^n a_i x_i,$$

故不等式(2)成立. 证毕.

注. 和尔塞(Hölder)不等式是一个重要而常用的不等式, 而且还可推广到一般的形式, 证明方法也很多. 例如, 可参看 G. H. Hardy, J. E. Littlewood, G. Pólya 合著的名著 "Inequalities" (Second Edition, 1952), Chapter I, 2.7-2.8.

3674. 对于 n 阶行列式 $A = |a_{ij}|$ 证明 哈达马不等式

$$A^2 \leq \prod_{i=1}^n \left(\sum_{j=1}^n a_{ij}^2 \right).$$

证 证法一

为区别起见, 以下用 A 表矩阵 (a_{ij}) , $|A|$ 表行列式 $|a_{ij}|$. 考虑函数 $u = |A| = |a_{ij}|$ 在条件 $\sum_{j=1}^n a_{ij}^2 = S_i$ ($i = 1, 2, \dots, n$) 下的极值问题. 其中 $S_i > 0$ ($i = 1, 2, \dots, n$).

由于上述 n 个条件限制下的 n^2 元点集是有界闭集, 故连续函数 u 必在其上取得最大值和最小值. 下面我们求函数 u 满足条件极值的必要条件. 设

$$F = u - \sum_{i=1}^n \lambda_i \left(\sum_{j=1}^n a_{ij}^2 - S_i \right).$$

由于函数 u 是多项式，当按第 i 行展开时，有

$$u = |A| = \sum_{j=1}^n a_{ij} A_{ij},$$

其中 A_{ij} 是 a_{ij} 的代数余子式。解方程组

$$\frac{\partial F}{\partial a_{ij}} = A_{ij} - 2\lambda_i a_{ij} = 0 \quad (i, j = 1, 2, \dots, n)$$

得 $a_{ij} = \frac{A_{ij}}{2\lambda_i}$ 。当 $i \neq k$ 时，有

$$\sum_{j=1}^n a_{ij} a_{kj} = \sum_{j=1}^n \frac{A_{ij} a_{kj}}{2\lambda_i} = \frac{1}{2\lambda_i} \sum_{j=1}^n A_{ij} a_{kj} = 0,$$

故当函数 u 满足极值的必要条件时，行列式不同的两行所对应的向量必直交。若以 A' 表示 A 的转置矩阵，则由行列式的乘法得

$$u^2 = |A'| \cdot |A| = \begin{vmatrix} S_1 0 & \cdots & 0 \\ 0 S_2 & \cdots & 0 \\ \cdots & \cdots & \cdots \\ 0 0 & \cdots & S_n \end{vmatrix} = \prod_{i=1}^n S_i.$$

因此，函数 u 满足极值的必要条件时，必有

$$u = \pm \sqrt{\prod_{i=1}^n S_i}.$$

由于显然函数 u 在条件 $\sum_{j=1}^n a_{ij}^2 = S_i$ ($i = 1, 2, \dots, n$) 下不恒为常数，故

$$u_{max} = \sqrt{\prod_{i=1}^n S_i}, \quad u_{min} = -\sqrt{\prod_{i=1}^n S_i}.$$

从而

$$|A|^2 \leq \prod_{i=1}^n S_i,$$

$$\text{当 } \sum_{j=1}^n a_{ij}^2 = S_i \quad (i=1, 2, \dots, n) \text{ 时,} \quad (1)$$

下面我们证明

$$|A|^2 \leq \prod_{i=1}^n \left(\sum_{j=1}^n a_{ij}^2 \right). \quad (2)$$

若至少有一个 i , 使 $\sum_{j=1}^n a_{ij}^2 = 0$, 则 $a_{ij} = 0$ ($j=1, 2, \dots, n$). 从而 $|A| = 0$, 于是不等式(2)显然成立.

若对一切 i ($i=1, 2, \dots, n$), 都有 $\sum_{j=1}^n a_{ij}^2 \neq 0$. 令

$S_i = \sum_{j=1}^n a_{ij}^2$, 则 $S_i > 0$ ($i=1, 2, \dots, n$). 于是, 根据不等式(1)即得

$$|A|^2 \leq \prod_{i=1}^n S_i = \prod_{i=1}^n \left(\sum_{j=1}^n a_{ij}^2 \right),$$

故不等式(2)成立. 证毕.

证法二

如将原题归一化, 则也可获证. 设

$$\bar{a}_{ij} = \frac{a_{ij}}{\left(\sum_{j=1}^n a_{ij}^2 \right)^{\frac{1}{2}}} \quad (i, j=1, 2, \dots, n),$$

则有

$$\sum_{i=1}^n \bar{a}_{ij}^2 = 1 \quad (i=1, 2, \dots, n).$$

从而原命题就可转化为证明不等式

$$|A| \leq 1,$$

其中 $\sum_{i=1}^n a_{ij}^2 = 1 (i=1, 2, \dots, n)$, $A = (a_{ij})$, $|A| = |a_{ij}|$.

设 $F = |A| + \sum_{i=1}^n \lambda_i \left(\sum_{j=1}^n a_{ij}^2 - 1 \right)$. 解方程组

$$\frac{\partial F}{\partial a_{ij}} = A_{ij} + 2\lambda_i a_{ij} = 0,$$

其中 A_{ij} 为 a_{ij} 的代数余子式 ($i, j=1, 2, \dots, n$). 于上式两端乘以 a_{ij} , 并对 $j=1, 2, \dots, n$ 求和, 即得

$$|A| + 2\lambda_i = 0 \quad (i=1, 2, \dots, n).$$

从而有

$$\lambda_i = -\frac{|A|}{2} \quad (i=1, 2, \dots, n),$$

也即

$$A_{ij} = a_{ij}|A| \quad (i, j=1, 2, \dots, n),$$

故得

$$\begin{vmatrix} A_{11} & \dots & A_{1n} \\ \vdots & & \vdots \\ A_{n1} & \dots & A_{nn} \end{vmatrix} = \begin{vmatrix} a_{11}|A| & \dots & a_{1n}|A| \\ \vdots & & \vdots \\ a_{n1}|A| & \dots & a_{nn}|A| \end{vmatrix},$$

上式左端的行列式叫做 $|A|$ 的附属行列式, 记为 $|A^*|$. 由线性代数知识可知, 当 $|A|=0$ 时, $|A^*|=0$. 当 $|A|$

$$\neq 0 \text{ 时, } |A||A^*| = \begin{vmatrix} |A| & 0 & \dots & 0 \\ 0 & |A| & \dots & 0 \\ \dots & \dots & \dots & \dots \\ 0 & 0 & \dots & |A| \end{vmatrix} = |A|^n, \text{ 故有}$$

$|A^*| = |A|^{n-1}$. 于是,

$$|A|^{n-1} = |A|^{n+1}.$$

由于 $|A|$ 的极值必须满足上式, 故不难推知 $|A|_{\max} =$

1 , $|A|_{\min} = -1$. 从而得知: 当 $\sum_{i=1}^n a_{ij}^2 = 1$ ($i=1,$

$2, \dots, n$) 时, 恒有

$$|A|^2 \leq 1 \text{ 或 } |A| \leq 1.$$

求下列函数在指定域内的上确界(sup)和下确界(inf):

3675. $z = x - 2y - 3$, 若 $0 \leq x \leq 1$, $0 \leq y \leq 1$, $0 \leq x + y \leq 1$.

解 以 D 表区域 $0 \leq x \leq 1$, $0 \leq y \leq 1$, $0 \leq x + y \leq 1$, 它是一个有界闭区域(为一闭三角形), 故连续函数 z 在其上必有最大值和最小值. 由于 z 是 x, y 的线性函数, 故不存在静止点, 因此, 最大值与最小值都在 D 的边界上达到. D 的边界为三条直线段: $y = 0$ ($0 \leq x \leq 1$), $x = 0$ ($0 \leq y \leq 1$), $x + y = 1$ ($0 \leq x \leq 1$); 在其上 z 分别变成一元函数: $z = x - 3$ ($0 \leq x \leq 1$), $z = -2y - 3$ ($0 \leq y \leq 1$), $z = 3x - 5$ ($0 \leq x \leq 1$). 由于这些函数都是一元线性函数, 故也无静止点, 其最大值与最小值必在此三线段的端点(即点 $(0, 0)$, 点 $(1, 0)$, 点 $(0, 1)$) 达到. 由此可知, z 在 D 上的最大值与最小值必在此三点 $(0, 0), (1, 0), (0, 1)$ 中达到.

由于

$$z(0, 0) = -3, \quad z(1, 0) = -2, \quad z(0, 1) = -5,$$

故

$$\sup z = -2, \quad \inf z = -5.$$

3676. $z = x^2 + y^2 - 12x + 16y$, 若 $x^2 + y^2 \leq 25$.

解 考虑函数 z 在区域 $x^2 + y^2 \leq 25$ 内的静止点:

$$\begin{cases} \frac{\partial z}{\partial x} = 2x - 12 = 0, \\ \frac{\partial z}{\partial y} = 2y + 16 = 0. \end{cases}$$

在区域内无解, 故连续函数 z 的最大值与最小值必在边界 $x^2 + y^2 = 25$ 上达到.

考虑函数 z 在边界 $x^2 + y^2 = 25$ 上的条件极值. 设 $F(x, y) = z - \lambda(x^2 + y^2 - 25)$. 解方程组

$$\begin{cases} \frac{\partial F}{\partial x} = 2x - 12 - 2\lambda x = 0, \\ \frac{\partial F}{\partial y} = 2y + 16 - 2\lambda y = 0, \\ x^2 + y^2 = 25 \end{cases}$$

可得静止点 $P_1(3, -4)$ 及 $P_2(-3, 4)$. 由于

$$z(3, -4) = -75, \quad z(-3, 4) = 125,$$

故得

$$\sup z = 125, \quad \inf z = -75.$$

3677. $z = x^2 - xy + y^2$, 若 $|x| + |y| \leq 1$.

解 求函数 z 在区域 $|x| + |y| \leq 1$ 内的静止点:

$$\begin{cases} \frac{\partial z}{\partial x} = 2x - y = 0, \\ \frac{\partial z}{\partial y} = 2y - x = 0, \end{cases}$$

解得静止点 $P_0(0, 0)$. 相应地, $z(P_0) = 0$.

再在边界: $x \geq 0, y \geq 0, x+y=1$ 上求静止点. 设 $F_1 = x^2 - xy + y^2 - \lambda(x+y-1)$.

解方程组

$$\begin{cases} \frac{\partial F_1}{\partial x} = 2x - y - \lambda = 0, \\ \frac{\partial F_1}{\partial y} = 2y - x - \lambda = 0, \\ x + y = 1 \end{cases}$$

得静止点 $P_1(\frac{1}{2}, \frac{1}{2})$. 相应地, $z(P_1) = \frac{1}{4}$.

同法可在另外三条边界线: $x \geq 0, y \leq 0, x - y = 1$ 上; $x \leq 0, y \geq 0, x - y = -1$ 上; $x \leq 0, y \leq 0, x + y = -1$ 上分别求得静止点 $P_2(\frac{1}{2}, -\frac{1}{2})$, $P_3(-\frac{1}{2}, \frac{1}{2})$ 及 $P_4(-\frac{1}{2}, -\frac{1}{2})$. 相应地, $z(P_2) = z(P_3) = \frac{3}{4}$, $z(P_4) = \frac{1}{4}$.

最后, 在上述四条边界线的端点 $P_5(1, 0), P_6(0, 1), P_7(-1, 0)$ 及 $P_8(0, -1)$ 上求得函数值:

$$z(P_5) = z(P_6) = z(P_7) = z(P_8) = 1.$$

比较 $z(P_i)$ ($i=0, 1, 2, \dots, 8$), 即得

$$\sup z = 1, \quad \inf z = 0.$$

3678. $u = x^2 + 2y^2 + 3z^2$, 若 $x^2 + y^2 + z^2 \leq 100$.

解 容易求得函数 u 在区域 $x^2 + y^2 + z^2 \leq 100$ 内的静止点为 $P_0(0, 0, 0)$, 而在边界 $x^2 + y^2 + z^2 = 100$ 上的静止点为 $P_1(10, 0, 0), P_2(-10, 0, 0), P_3(0, 10, 0),$

$P_4(0, -10, 0)$, $P_5(0, 0, 10)$ 及 $P_6(0, 0, -10)$. 相应地, $u(P_0) = 0$, $u(P_1) = u(P_2) = 100$, $u(P_3) = u(P_4) = 200$, $u(P_5) = u(P_6) = 300$. 于是,

$$\sup u = 300, \quad \inf u = 0.$$

3679. $u = x + y + z$, 若 $x^2 + y^2 \leq z \leq 1$.

解 所讨论的立体区域由曲面 $x^2 + y^2 = z$ ($0 \leq z \leq 1$) 和平面 $z = 1$, $x^2 + y^2 \leq 1$ 所围成, 两个曲面的交线为 $x^2 + y^2 = z = 1$.

显见在立体区域内部无静止点. 在边界面 $z = 1$, $x^2 + y^2 \leq 1$ 的内部, $u(x, y, 1) = x + y + 1$ 也无静止点. 在边界面 $x^2 + y^2 = z$ ($0 \leq z \leq 1$) 上, 有

$$u = x + y + x^2 + y^2 \quad (x^2 + y^2 \leq 1).$$

解方程组

$$\begin{cases} \frac{\partial u}{\partial x} = 1 + 2x = 0, \\ \frac{\partial u}{\partial y} = 1 + 2y = 0 \end{cases}$$

得静止点 $P_1(-\frac{1}{2}, -\frac{1}{2}, \frac{1}{2})$. 相应地, $u(P_1) = -\frac{1}{2}$.

在边界线 $x^2 + y^2 = z = 1$ 上, 设

$$F(x, y) = x + y + 1 + \lambda(x^2 + y^2 - 1).$$

解方程组

$$\begin{cases} \frac{\partial F}{\partial x} = 1 + 2\lambda x = 0, \\ \frac{\partial F}{\partial y} = 1 + 2\lambda y = 0, \\ x^2 + y^2 = 1 \end{cases}$$

得静止点 $P_2\left(\frac{1}{\sqrt{2}}, \frac{1}{\sqrt{2}}, 1\right)$ 及 $P_3\left(-\frac{1}{\sqrt{2}}, -\frac{1}{\sqrt{2}}, 1\right)$. 相应地, $u(P_2) = 1 + \sqrt{2}$, $u(P_3) = 1 - \sqrt{2}$. 于是,

$$\sup u = 1 + \sqrt{2}, \inf u = -\frac{1}{2}.$$

3680. 求函数

$$u = (x + y + z)e^{-(x+2y+3z)}$$

在域 $x > 0$, $y > 0$, $z > 0$ 内的下确界 (inf) 与上确界 (sup).

解 函数 u 在区域 $x \geq 0$, $y \geq 0$, $z \geq 0$ 上是连续函数, 因此, 把区域扩大包括边界时, 上、下确界不变, 下面就扩大后的区域加以讨论.

显然当 $x \geq 0$, $y \geq 0$, $z \geq 0$ 时 $u \geq 0$, 且 $u(0, 0, 0) = 0$, 故 $\inf u = 0$.

在区域内部, 由于

$$\frac{\partial u}{\partial x} = e^{-(x+2y+3z)} [1 - (x+y+z)],$$

$$\frac{\partial u}{\partial y} = e^{-(x+2y+3z)} [1 - 2(x+y+z)],$$

$$\frac{\partial u}{\partial z} = e^{-(x+2y+3z)} [1 - 3(x+y+z)],$$

而 $e^{-(x+2y+3z)} \neq 0$, 故函数 u 在域内无静止点.

又因

$$\begin{aligned} u &= (x+y+z)e^{-(x+2y+3z)} = (x+y+z)e^{-(x+y+z)} \\ &\cdot e^{-(y+2z)} \leq (x+y+z)e^{-(x+y+z)} \rightarrow 0 \quad [(x+y+z) \rightarrow \\ &+\infty], \end{aligned}$$

故函数 u 的最大值必在有限的边界上达到. 考虑界面:

$$x=0; u(0, y, z) = (y+z)e^{-(2y+3z)}, y \geq 0, z \geq 0.$$

$$y=0; u(x, 0, z) = (x+z)e^{-(x+3z)}, x \geq 0, z \geq 0.$$

$$z=0; u(x, y, 0) = (x+y)e^{-(x+2y)}, x \geq 0, y \geq 0.$$

同样可证明, 这些界面上无静止点.

最后考虑边界线: $x=0, y=0, z \geq 0,$

$$u(0, 0, z) = ze^{-3z}$$

可解得静止点 $P_1(0, 0, \frac{1}{3})$. 相应地, $u(P_1) = \frac{1}{3}e^{-1}$.

同法在边界线: $x=0, z=0, y \geq 0$ 上可解得静止

点 $P_2(0, \frac{1}{2}, 0)$; 在边界线: $y=0, z=0, x \geq 0$

上可解得静止点 $P_3(1, 0, 0)$. 相应地, $u(P_2) = \frac{1}{2}e^{-1},$

$u(P_3) = e^{-1}$. 至于边界线的一端为原点, 另一端伸向无穷远, 均已讨论过. 于是,

$$\sup u = e^{-1}.$$

3681. 证明: 函数 $z = (1+e^y) \cos x - ye^y$ 有无穷多个极大值而无一极小值.

证 解方程组

$$\begin{cases} \frac{\partial z}{\partial x} = -(1+e^y) \sin x = 0, \\ \frac{\partial z}{\partial y} = e^y(\cos x - 1 - y) = 0 \end{cases}$$

得 $x = k\pi, y = (-1)^k - 1$ ($k = 0, \pm 1, \pm 2, \dots$).

由于

$$\frac{\partial^2 z}{\partial x^2} = -(1+e^y)\cos x, \quad \frac{\partial^2 z}{\partial x \partial y} = -e^y \sin x,$$

$$\frac{\partial^2 z}{\partial y^2} = e^y(\cos x - 2 - y),$$

故在点 $(2m\pi, 0)$ ($m=0, \pm 1, \dots$), $A=-2, B=0, C=-1$ 及 $AC-B^2=2 > 0$, 此时函数 z 取得极大值; 而在点 $((2m+1)\pi, -2)$ ($m=0, \pm 1, \dots$), $A=1+e^{-2}, B=0, C=-e^{-2}$ 及 $AC-B^2=-e^{-2}-e^{-4} < 0$, 此时函数 z 无极值.

3682. 函数 $f(x, y)$ 在点 $M_0(x_0, y_0)$ 有极小值的充分条件是否为此函数在沿着过 M_0 点的每一条直线上有极小值呢?

解 研究函数

$$f(x, y) = (x - y^2)(2x - y^2).$$

对于每一条通过原点的直线: $y = kx$ ($-\infty < x < +\infty$) 均有

$$\begin{aligned} f(x, kx) &= (x - k^2x^2)(2x - k^2x^2) \\ &= x^2(1 - k^2x)(2 - k^2x), \end{aligned}$$

当 $0 < |x| < \frac{1}{k^2}$ 时, $f(x, kx) > 0$. 但是 $f(0, 0) = 0$, 因此, 函数 $f(x, y)$ 在直线 $y = kx$ 上在原点取得极小值零.

对于通过原点的另一条直线: $x = 0$, 有 $f(0, y) = y^4$, 故在原点也取得极小值零.

因此, 函数 $f(x, y)$ 在一切通过原点的直线上均有极小值. 但是,

$$f(a, \sqrt{1.5a}) = -0.25a^2 < 0 \quad (a > 0),$$

因此, 函数 $f(x, y)$ 在 $(0, 0)$ 点不取得极小值.

此例说明: 尽管 $f(x, y)$ 在沿着过点 M_0 的每一条直线上在 M_0 均有极小值, 但却不能保证 $f(x, y)$ 作为二元函数在点 M_0 一定有极小值.

3683. 分解已知正数 a 为 n 个正的因数, 使得它们的倒数的和为最小.

解 按题设, 我们应求函数 $u = \sum_{i=1}^n \frac{1}{x_i}$ 在条件 $a = \prod_{i=1}^n x_i$

或 $\ln a = \sum_{i=1}^n \ln x_i$ ($a > 0, x_i > 0$) 下的极值. 设 $F(x_1,$

$x_2, \dots, x_n) = u + \lambda \left(\sum_{i=1}^n \ln x_i - \ln a \right)$. 解方程组

$$\begin{cases} \frac{\partial F}{\partial x_i} = -\frac{1}{x_i^2} + \frac{\lambda}{x_i} = 0 & (i=1, 2, \dots, n), \\ a = \prod_{i=1}^n x_i \end{cases}$$

可得 $x_i = \frac{1}{\lambda}$ ($i=1, 2, \dots, n$). 从而解得

$$x_1^0 = x_2^0 = \dots = x_n^0 = a^{\frac{1}{n}}, u(x_1^0, x_2^0, \dots, x_n^0) = na^{-\frac{1}{n}}.$$

当点 $P(x_1, x_2, \dots, x_n)$ 趋向于边界时, 至少有一个 $x_i \rightarrow 0$, 即 $\frac{1}{x_i} \rightarrow +\infty$, 而 $u \geq \frac{1}{x_i}$, 故 $u \rightarrow +\infty$.

因此, 函数 u 必在区域内部取得最小值. 于是, 将正数 a 分为 n 个相等的正的因数 $a^{\frac{1}{n}}$ 时, 其倒数和 $na^{-\frac{1}{n}}$ 最小.

3684. 分解已知正数 a 为 n 个相加数, 使得它们的平方和为最小.

解 考虑函数 $u = \sum_{i=1}^n x_i^2$ 在条件 $a = \sum_{i=1}^n x_i$ ($a > 0$) 下的极值. 设 $F(x_1, x_2, \dots, x_n) = u + \lambda \left(\sum_{i=1}^n x_i - a \right)$. 解方程组

$$\begin{cases} \frac{\partial F}{\partial x_i} = 2x_i + \lambda = 0 & (i=1, 2, \dots, n), \\ \sum_{i=1}^n x_i = a \end{cases}$$

得 $x_1^0 = x_2^0 = \dots = x_n^0 = \frac{a}{n}$, $u(x_1^0, x_2^0, \dots, x_n^0) = \frac{a^2}{n}$.

当 n 个相加数中有若干个相加数 $\rightarrow \pm \infty$ 时, 平方和 $\rightarrow +\infty$. 因此, 函数 u 必在有限区域内取得最小值. 于是, 将正数 a 分解为 n 个相等的相加数 $\frac{a}{n}$ 时, 其平方和 $\frac{a^2}{n}$ 最小.

3685. 分解已知正数 a 为 n 个正的因数, 使得它们的已知正乘幂的和为最小.

解 考虑函数 $u = \sum_{i=1}^n x_i^{\alpha_i}$ ($\alpha_i > 0$) 在条件 $\ln a = \sum_{i=1}^n \ln x_i$ ($a > 0, x_i > 0$) 下的极值. 设 $F = u - \lambda \left(\sum_{i=1}^n \ln x_i - \ln a \right)$. 解方程组

$$\begin{cases} \frac{\partial F}{\partial x_i} = \alpha_i x_i^{\alpha_i - 1} - \frac{\lambda}{x_i} = 0 & (i=1, 2, \dots, n), \quad (1) \\ \sum_{i=1}^n \ln x_i = \ln a. \quad (2) \end{cases}$$

由 (1) 得 $x_i = \left(\frac{\lambda}{\alpha_i}\right)^{\frac{1}{\alpha_i}}$. 代入 (2), 得

$$\ln a + \sum_{i=1}^n \frac{\ln \alpha_i}{\alpha_i} = \ln \lambda \sum_{i=1}^n \frac{1}{\alpha_i}.$$

令 $\beta = \sum_{i=1}^n \frac{1}{\alpha_i}$, 则有

$$\lambda = a^{\frac{1}{\beta}} \prod_{i=1}^n \alpha_i^{\frac{1}{\beta \alpha_i}} = \left(a \prod_{i=1}^n \alpha_i^{\frac{1}{\alpha_i}} \right)^{\frac{1}{\beta}},$$

$$x_i^0 = \frac{\left(a \prod_{i=1}^n \alpha_i^{\frac{1}{\alpha_i}} \right)^{\frac{1}{\sum_{i=1}^n \frac{1}{\alpha_i}}}}{\left(\alpha_i \right)^{\frac{1}{\alpha_i}}} \quad (i=1, 2, \dots, n),$$

$$u = \sum_{i=1}^n \frac{\lambda}{\alpha_i} = \beta \lambda = \left(\sum_{i=1}^n \frac{1}{\alpha_i} \right) \left(a \prod_{i=1}^n \alpha_i^{\frac{1}{\alpha_i}} \right)^{\frac{1}{\sum_{i=1}^n \frac{1}{\alpha_i}}}.$$

显然, 函数 u 在区域内部达到最小值. 于是, 所求得的 u 即为最小值.

3686. 已知在平面上的 n 个质点 $P_1(x_1, y_1), P_2(x_2, y_2), \dots, P_n(x_n, y_n)$, 其质量分别为 m_1, m_2, \dots, m_n .

$P(x, y)$ 点在怎样的位置, 这一体系对于此点的转动惯量为最小?

解 设 $f(x, y) = \sum_{i=1}^n m_i [(x-x_i)^2 + (y-y_i)^2]$. 解方

$$\begin{cases} \frac{\partial f}{\partial x} = 2 \sum_{i=1}^n m_i (x - x_i) = 0, \\ \frac{\partial f}{\partial y} = 2 \sum_{i=1}^n m_i (y - y_i) = 0 \end{cases}$$

得

$$x_0 = \frac{1}{M} \sum_{i=1}^n m_i x_i, \quad y_0 = \frac{1}{M} \sum_{i=1}^n m_i y_i,$$

其中 $M = \sum_{i=1}^n m_i$.

当 $x \rightarrow \infty$ 或 $y \rightarrow \infty$ 时, 显然 $f \rightarrow +\infty$. 因此, 点 $P(x_0, y_0)$ 即为所求.

3687. 已知容积为 V 的开顶长方浴盆, 当其尺寸怎样时, 有最小的表面积?

解 设浴盆长、宽、高分别为 x 、 y 、 h , 则考虑函数 $S = 2(x+y)h + xy$ 在条件 $V = xyh$ ($x > 0$, $y > 0$, $h > 0$) 下的极值.

设 $F(x, y, h) = S - \lambda(xyh - V)$. 解方程组

$$\begin{cases} \frac{\partial F}{\partial x} = y + 2h - \lambda y h = 0, & (1) \\ \frac{\partial F}{\partial y} = x + 2h - \lambda x h = 0, & (2) \\ \frac{\partial F}{\partial h} = 2(x+y) - \lambda xy = 0, & (3) \\ xyh = V. \end{cases}$$

(1), (2), (3) 可改写为

$$\frac{1}{h} + \frac{2}{y} = \lambda = \frac{1}{h} + \frac{2}{x} = \frac{2}{x} + \frac{2}{y},$$

故有

$$x_0 = y_0 = 2h_0 = \sqrt[3]{2V}, \quad h_0 = \frac{1}{2}\sqrt[3]{2V} = \sqrt[3]{\frac{V}{4}}.$$

从实际问题的常识可以断定,一定在某一处达到最小.

因此,当长宽均为 $\sqrt[3]{2V}$,高为 $\sqrt[3]{\frac{V}{4}}$ 时,浴盆的表面积最小,且最小表面积为 $S = 3\sqrt[3]{4V^2}$.

从数学上来考虑,应讨论 x, y, h 趋于边界的情况.当 x, y, h 中有任一个趋于零,例如, $h \rightarrow +0$,则由 $V = xyh$ 即可断定 $xy \rightarrow +\infty$.但是, $S \gg xy$,故 $S \rightarrow +\infty$.当 x, y, h 中有任一个趋于 $+\infty$ 时,一定引起至少有另一个趋于零.重复上面的讨论可知 $S \rightarrow +\infty$.因此,连续函数 S 必在区域内部取得最小值.

3688. 横断面为半圆形的圆柱形的张口浴盆,其表面积等于 S ,当其尺寸怎样时,此盆有最大的容积?

解 设圆柱半径为 r ,高为 h ,则考虑函数 $V = \frac{1}{2}\pi r^2 h$ 在条件 $S = \pi(r^2 + rh)$ ($r > 0, h > 0$)下的极值.为简单起见,忽略系数 $\frac{1}{2}\pi$.设 $F = r^2 h - \lambda(r^2 + rh - \frac{S}{\pi})$.

解方程组

$$\begin{cases} \frac{\partial F}{\partial r} = 2rh - \lambda(2r + h) = 0, \\ \frac{\partial F}{\partial h} = r^2 - \lambda r = 0, \\ r^2 + rh = \frac{S}{\pi} \end{cases}$$

得

$$r_0 = \sqrt{\frac{S}{3\pi}}, \quad h_0 = 2\sqrt{\frac{S}{3\pi}},$$

$$\text{从而有 } V_0 = \frac{1}{2} \pi r_0^2 h_0 = \sqrt{\frac{S^3}{27\pi^3}}.$$

由实际情况知, V 一定达到最大体积. 因此, 当 $h_0 = 2r_0 = 2\sqrt{\frac{S}{3\pi}}$ 时, 体积 $V_0 = \sqrt{\frac{S^3}{27\pi^3}}$ 最大.

从数学角度看, 由 $r^2 + rh = \frac{S}{\pi}$ 知 r^2 和 rh 恒有界.

当 $r \rightarrow +0$ 或 $h \rightarrow +0$ 时必有 $V \rightarrow 0$. 当 $h \rightarrow +\infty$ 时, 由 rh 有界可推出 $r \rightarrow +0$. 因而 $V \rightarrow 0$ (显然不可能 $r \rightarrow +\infty$). 于是, 体积 V 必在区域内部达到最大值.

3689. 在球面 $x^2 + y^2 + z^2 = 1$ 上求出一点, 这点到 n 个已知点 $M_i(x_i, y_i, z_i) (i=1, 2, \dots, n)$ 距离的平方和为最小.

解 考虑函数 $u = \sum_{i=1}^n [(x-x_i)^2 + (y-y_i)^2 + (z-z_i)^2]$ 在条件 $x^2 + y^2 + z^2 = 1$ 下的极值. 设 $F(x, y, z) = u - \lambda(x^2 + y^2 + z^2 - 1)$.

解方程组

$$\begin{cases} \frac{\partial F}{\partial x} = 2 \left[\sum_{i=1}^n (x-x_i) - \lambda x \right] = 2 \left[(n-\lambda)x - \sum_{i=1}^n x_i \right] \\ \quad = 0, & (1) \\ \frac{\partial F}{\partial y} = 2 \left[(n-\lambda)y - \sum_{i=1}^n y_i \right] = 0, & (2) \\ \frac{\partial F}{\partial z} = 2 \left[(n-\lambda)z - \sum_{i=1}^n z_i \right] = 0, & (3) \\ x^2 + y^2 + z^2 = 1. & (4) \end{cases}$$

由 (1), (2), (3) 得

$$x = \frac{1}{n-\lambda} \sum_{i=1}^n x_i, \quad y = \frac{1}{n-\lambda} \sum_{i=1}^n y_i, \quad z = \frac{1}{n-\lambda} \sum_{i=1}^n z_i,$$

代入 (4), 得

$$(n-\lambda)^2 = \left(\sum_{i=1}^n x_i \right)^2 + \left(\sum_{i=1}^n y_i \right)^2 + \left(\sum_{i=1}^n z_i \right)^2 = N^2$$

($N > 0$). 于是, 得

$$x' = \frac{1}{N} \sum_{i=1}^n x_i, \quad y' = \frac{1}{N} \sum_{i=1}^n y_i, \quad z' = \frac{1}{N} \sum_{i=1}^n z_i$$

及

$$x'' = -\frac{1}{N} \sum_{i=1}^n x_i, \quad y'' = -\frac{1}{N} \sum_{i=1}^n y_i, \quad z'' = -\frac{1}{N} \sum_{i=1}^n z_i.$$

从而,

$$\begin{aligned} u(x', y', z') &= \sum_{i=1}^n \left[(x' - x_i)^2 + (y' - y_i)^2 + (z' - z_i)^2 \right] \\ &= n(x'^2 + y'^2 + z'^2) - 2x' \sum_{i=1}^n x_i - 2y' \sum_{i=1}^n y_i \\ &\quad - 2z' \sum_{i=1}^n z_i + \sum_{i=1}^n (x_i^2 + y_i^2 + z_i^2) \\ &= n - \frac{2}{N} \left[\left(\sum_{i=1}^n x_i \right)^2 + \left(\sum_{i=1}^n y_i \right)^2 + \left(\sum_{i=1}^n z_i \right)^2 \right] \\ &\quad + \sum_{i=1}^n (x_i^2 + y_i^2 + z_i^2) \\ &= n - 2N + \sum_{i=1}^n (x_i^2 + y_i^2 + z_i^2). \end{aligned}$$

同法可求得

$$\begin{aligned} u(x'', y'', z'') &= n + 2N + \sum_{i=1}^n (x_i^2 + y_i^2 + z_i^2) \\ &> u(x', y', z'). \end{aligned}$$

由于函数 u 在闭球面 $x^2 + y^2 + z^2 = 1$ 上连续, 故必取得最大值及最小值. 于是, 当 $x = x', y = y', z = z'$ 时, u 最小 (同时也证明了当 $x = x'', y = y'', z = z''$ 时, u 最大).

3690. 由直圆柱及以直圆锥作顶构成一个体. 当已知体的全表面积等于 Q 时, 求它的尺寸大小, 使得体的体积为最大.

解 设圆柱部分的底半径为 R , 高为 h ; 圆锥部分的母线与底面的夹角为 α , 则有 $\pi R^2 + 2\pi Rh + \frac{\pi R^2}{\cos \alpha} = Q$ (常数) ($R > 0, h > 0, 0 \leq \alpha < \frac{\pi}{2}$). 考虑函数 $V(\alpha, h, R) = \pi R^2 h + \frac{1}{3} \pi R^3 \operatorname{tg} \alpha$ 在上述条件下的极值. 设

$$F(\alpha, h, R) = 3R^2 h + R^3 \operatorname{tg} \alpha - \lambda \left(R^2 + 2Rh + \frac{R^2}{\cos \alpha} - \frac{Q}{\pi} \right).$$

解方程组

$$\begin{cases} \frac{\partial F}{\partial \alpha} = \frac{R^3}{\cos^2 \alpha} - \frac{\lambda R^2 \sin \alpha}{\cos^2 \alpha} = 0, & (1) \\ \frac{\partial F}{\partial h} = 3R^2 - 2R\lambda = 0, & (2) \\ \frac{\partial F}{\partial R} = 6Rh + 3R^2 \operatorname{tg} \alpha - \left(2R + 2h + \frac{2R}{\cos \alpha} \right) \lambda = 0, & (3) \\ R^2 + 2Rh + \frac{R^2}{\cos \alpha} = \frac{Q}{\pi}. & (4) \end{cases}$$

由 (2) 得 $\lambda = \frac{3}{2}R$. 代入 (1), 得 $\sin\alpha = \frac{2}{3}$. 由于 $0 \leq \alpha < \frac{\pi}{2}$, 故由 $\sin\alpha = \frac{2}{3}$ 得 $\cos\alpha = \frac{\sqrt{5}}{3}$, $\operatorname{tg}\alpha = \frac{2}{\sqrt{5}}$. 代入 (3), 得

$$6Rh + \frac{6}{\sqrt{5}}R^2 = 3R^2 + 3Rh + \frac{9}{\sqrt{5}}R^2,$$

即

$$Rh = R^2 + \frac{R^2}{\sqrt{5}} \text{ 或 } h = \left(1 + \frac{1}{\sqrt{5}}\right)R.$$

代入 (4), 得

$$R^2 + \left(2 + \frac{2}{\sqrt{5}}\right)R^2 + \frac{3}{\sqrt{5}}R^2 = \frac{Q}{\pi}.$$

于是,

$$R = \frac{\sqrt{2}(\sqrt{5}-1)}{4} \sqrt{\frac{Q}{\pi}}.$$

相应地, 有

$$\begin{aligned} V_0 &= \pi R^2 h + \frac{1}{3}\pi R^3 \operatorname{tg}\alpha = \left(1 + \frac{1}{\sqrt{5}} + \frac{2}{3\sqrt{5}}\right)\pi R^3 \\ &= \left(1 + \frac{5}{3\sqrt{5}}\right)\pi R^2 \cdot R = \frac{3 + \sqrt{5}}{3} \pi \cdot \frac{3 - \sqrt{5}}{4} \frac{Q}{\pi} \\ &= \frac{\sqrt{2}(\sqrt{5}-1)}{4} \sqrt{\frac{Q}{\pi}} = \frac{\sqrt{2}(\sqrt{5}-1)}{12} \sqrt{\frac{Q^3}{\pi}}. \end{aligned}$$

现在讨论边界情况. 由 (4) 知 R^2 , Rh 及 $\frac{R^2}{\cos\alpha}$ 均为正的有界量.

(i) 当 $R \rightarrow +0$ 时, 由 Rh 及 $\frac{R^2}{\cos\alpha}$ 有界可知

$$V = \pi(Rh)R + \frac{\pi}{3} \left(\frac{R^2}{\cos \alpha} \right) \sin \alpha \cdot R \rightarrow 0.$$

(ii) 当 $h \rightarrow +0$ (所研究的体退化为圆锥) 时, 需要求当圆锥全表面积 $\pi R^2 + \frac{\pi R^2}{\cos \alpha} = Q$ (常数) 时圆锥体积 $V = \frac{1}{3} \pi R^3 \operatorname{tg} \alpha$ 的最大值. 用 l 表圆锥的斜

$$\text{高, 即 } l = \frac{R}{\cos \alpha}, R \operatorname{tg} \alpha = \sqrt{\frac{R^2}{\cos^2 \alpha} - R^2} = \sqrt{l^2 - R^2}.$$

于是, $l = \frac{Q - \pi R^2}{\pi R}$, $V = \frac{1}{3} \pi R^2 \sqrt{l^2 - R^2}$, 故

$$V^2 = \frac{1}{9} QR^2(Q - 2\pi R^2) \left(0 < R < \sqrt{\frac{Q}{\pi}} \right).$$

由此易知 V^2 (从而 V) 当 $R^2 = \frac{Q}{4\pi}$ (即 $R = \frac{1}{2} \sqrt{\frac{Q}{\pi}}$) 时达最大值, 并且最大体积 $V_1 = \frac{1}{6\sqrt{2}} \sqrt{\frac{Q^3}{\pi}}$.

不难验证 $V_1 < V_0$.

(iii) 当 $h \rightarrow +\infty$ 时, 由 Rh 有界知 $R \rightarrow +0$. 由(i)知 $V \rightarrow 0$.

(iv) 当 $\alpha \rightarrow \frac{\pi}{2} - 0$ 时, 由 $\frac{R^2}{\cos \alpha}$ 有界可知 $R \rightarrow +0$, 由(i)知 $V \rightarrow 0$.

(v) 当 $\alpha \rightarrow +0$ (所研究的体退化为圆柱) 时, 可以求得达到最大体积的尺寸为 $h = 2R$ 及 $Q = \sqrt[3]{54\pi} V_2^{\frac{2}{3}}$ (参看1563题), 即

$$V_2 = \sqrt{\frac{Q^3}{54\pi}} = \frac{\sqrt{6}}{18} \sqrt{\frac{Q^3}{\pi}}.$$

不难证明 $V_2 \leq V_0$.

综上所述, 我们得到当 $R = \frac{\sqrt{2}(\sqrt{5}-1)}{4} \sqrt{\frac{Q}{\pi}}$,
 $\alpha = \arcsin \frac{2}{3}$ 时, 所研究的体积 V 达到最大值

$$V_0 = \frac{\sqrt{2}(\sqrt{5}-1)}{12} \sqrt{\frac{Q^3}{\pi}}.$$

3691. 一个体, 其体积等于 V , 形为直角平行直六面体, 上底及下底为正的四角锥. 当角锥的侧面对它们的底成怎样的倾角, 体的全表面积为最小?

解 设长方体两底 (正方形) 边长为 a , 高为 h , 棱锥侧面与底面的夹角为 α , 则 $V = a^2 h + \frac{1}{3} a^3 \operatorname{tg} \alpha$. 考虑函数 $S = 4ah + \frac{2a^2}{\cos \alpha}$ 在上述条件下的极值. 设 $F =$

$S - \lambda \left(a^2 h + \frac{1}{3} a^3 \operatorname{tg} \alpha - V \right)$. 解方程组

$$\begin{cases} \frac{\partial F}{\partial a} = 4h + \frac{4a}{\cos \alpha} - 2\lambda ah - \lambda a^2 \operatorname{tg} \alpha = 0, & (1) \\ \frac{\partial F}{\partial h} = 4a - \lambda a^2 = 0, & (2) \\ \frac{\partial F}{\partial \alpha} = \frac{2a^2 \sin \alpha}{\cos^2 \alpha} - \frac{\lambda a^3}{3 \cos^2 \alpha} = 0, & (3) \\ a^2 h + \frac{1}{3} a^3 \operatorname{tg} \alpha = V. & (4) \end{cases}$$

由 (2), (3) 可得 $\alpha = \arcsin \frac{2}{3}$. 同3690题进一步可求出 a 和 h .

类似3687题的讨论, 当 $a \rightarrow +0$, $a \rightarrow +\infty$, $h \rightarrow +\infty$, $\alpha \rightarrow \frac{\pi}{2} - 0$ 等情况均能证明 $S \rightarrow +\infty$. 对于边

界为 $\alpha = 0$ 及 $h = 0$ 这两种退化情况, 类似 3690 题, 可证明此时的全表面积比 $\alpha = \arcsin \frac{2}{3}$ 时的全表面积为大. 于是, 当 $\alpha = \arcsin \frac{2}{3}$ 时, 体的全表面积最小.

3692. 已知矩形的周长为 $2p$, 将它绕其一边旋转而构成一体积, 求所得体积为最大的那个矩形.

解 设矩形的边长为 x 及 y , 则考虑函数 $V = \pi y^2 x$ 在条件 $x + y = p$ 下的极值. 设 $F = V - \lambda(x + y - p)$. 解方程组

$$\begin{cases} \frac{\partial F}{\partial x} = \pi y^2 - \lambda = 0, \\ \frac{\partial F}{\partial y} = 2\pi xy - \lambda = 0, \\ x + y = p \end{cases}$$

得 $x = \frac{p}{3}$, $y = \frac{2p}{3}$.

由于在边界上, 一边为零, 一边为 p , 推出 $V = 0$.

于是, 当矩形的两边分别为 $\frac{p}{3}$ 及 $\frac{2p}{3}$ 时, 旋转体的体积最大.

3693. 已知三角形的周长为 $2p$, 求出这样的三角形, 当它绕着自己的一边旋转所构成的体积最大.

解 如图 6.43 所示, 以 AC 为轴旋转, 取参数: 高 h 及二角 α, β . 考虑函数



图 6.43

$$V = \frac{1}{3}\pi h^3(\operatorname{tg}\alpha + \operatorname{tg}\beta).$$

在条件 $\frac{h}{\cos\alpha} + \frac{h}{\cos\beta} + h(\operatorname{tg}\alpha + \operatorname{tg}\beta) = 2p$ 下的极值. 为

计算简单起见, 略去常数 $\frac{1}{3}\pi$. 设 $F = h^3(\operatorname{tg}\alpha + \operatorname{tg}\beta) - \lambda\left(\frac{h}{\cos\alpha} + \frac{h}{\cos\beta} + h\operatorname{tg}\alpha + h\operatorname{tg}\beta - 2p\right)$.

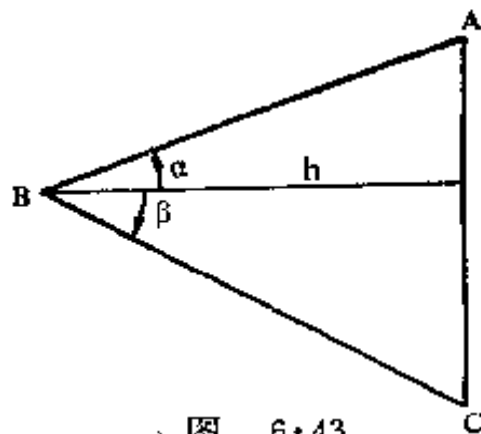
解方程组

$$\begin{cases} \frac{\partial F}{\partial h} = 3h^2(\operatorname{tg}\alpha + \operatorname{tg}\beta) - \lambda\left(\frac{1}{\cos\alpha} + \frac{1}{\cos\beta} + \operatorname{tg}\alpha + \operatorname{tg}\beta\right) = 0, & (1) \\ \frac{\partial F}{\partial \alpha} = \frac{h^3}{\cos^2\alpha} - \lambda h\left(\frac{\sin\alpha}{\cos^2\alpha} + \frac{1}{\cos^2\alpha}\right) = 0, & (2) \\ \frac{\partial F}{\partial \beta} = \frac{h^3}{\cos^2\beta} - \lambda h\left(\frac{\sin\beta}{\cos^2\beta} + \frac{1}{\cos^2\beta}\right) = 0, & (3) \\ h\left(\frac{1}{\cos\alpha} + \frac{1}{\cos\beta} + \operatorname{tg}\alpha + \operatorname{tg}\beta\right) = 2p. & (4) \end{cases}$$

由 (2) 及 (3) 得 $\alpha = \beta$ 及 $\lambda = \frac{h^2}{1 + \sin\alpha} = \frac{h^2}{1 + \sin\beta}$.

代入 (1) 式, 得 $\sin\alpha = \sin\beta = \frac{1}{3}$. 于是, $h\operatorname{tg}\alpha = \frac{h}{3\cos\alpha}$, 代入 (4) 式, 即得 $\frac{h}{\cos\alpha} = \frac{3}{4}p$. 从而, 得三边分别为

$$AB = BC = \frac{3}{4}p, \quad AC = 2h\operatorname{tg}\alpha = \frac{p}{2}.$$

讨论边界情况. 当 $h \rightarrow +0$ 或 $h \rightarrow p$ 时, 显然有

$V \rightarrow 0$, 对于二角 α 及 β 必有大小限制: $0 \leq \alpha < \frac{\pi}{2}$,
 $-\alpha \leq \beta \leq \alpha$ (注意 α, β 的方向规定不同), 当 $\alpha \rightarrow +0$
 或 $\alpha \rightarrow \frac{\pi}{2} - 0$ 或 $\beta \rightarrow -\alpha$ 时, 同样均有 $V \rightarrow 0$. 于是,
 当三角形的三边长分别为 $\frac{p}{2}$, $\frac{3p}{4}$ 及 $\frac{3p}{4}$, 并绕长为 $\frac{p}{2}$
 的边旋转时, 所得的体积最大.

3694. 在半径为 R 的半球内嵌入有最大体积的直角平行六面体.

解 不妨设此长方体的一个底面与半球所在的底面重合, 另外四个顶点在半球球面上, 且半球面在直角坐标系下的方程为

$$x^2 + y^2 + z^2 = R^2, z \geq 0.$$

又设长方体的长、宽、高分别为 $2x$ 、 $2y$ 及 z ($x > 0$,
 $y > 0, z > 0$). 考虑函数 $V = 4xyz$ 在上述条件下的极值. 设 $F = xyz - \lambda(x^2 + y^2 + z^2 - R^2)$.

解方程组

$$\begin{cases} \frac{\partial F}{\partial x} = yz - 2\lambda x = 0, \\ \frac{\partial F}{\partial y} = xz - 2\lambda y = 0, \\ \frac{\partial F}{\partial z} = xy - 2\lambda z = 0, \\ x^2 + y^2 + z^2 = R^2 \end{cases}$$

可得 $x = y = z = \frac{R}{\sqrt{3}}$.

由于在边界上(即 $x \rightarrow +0$ 或 $y \rightarrow +0$ 或 $z \rightarrow +0$ 时)显然 $V \rightarrow 0$, 故当直角平行六面体的长、宽、高为 $\frac{2R}{\sqrt{3}}$, $\frac{2R}{\sqrt{3}}$ 及 $\frac{R}{\sqrt{3}}$ 时, 其体积最大.

3695. 在已知的直圆锥内嵌入有最大体积的直角平行六面体.

解 不妨设直圆锥的底面半径为 R , 高为 H , 且长方体的一个面与直圆锥的底面重合, 两个边长为 $2x$ 和 $2y$, 四个顶点在直圆锥面上, 高为 z . 过直圆锥的高和长方体底面的对角



图 6.44

线作一截面, 如图6.44所示, 则 $CD=H$, $EK=FG=z$, $AD=R$, $DE=\sqrt{x^2+y^2}$, $(H-z)R=H \cdot \sqrt{x^2+y^2}$ (R, H 为常数). 考虑函数 $V=4xyz$ 在上述条件下的极值 ($x>0, y>0, z>0$). 为计算简单计, 略去常数4. 设

$$F = xyz - \lambda [H \sqrt{x^2 + y^2} - (H - z)R].$$

解 方程组

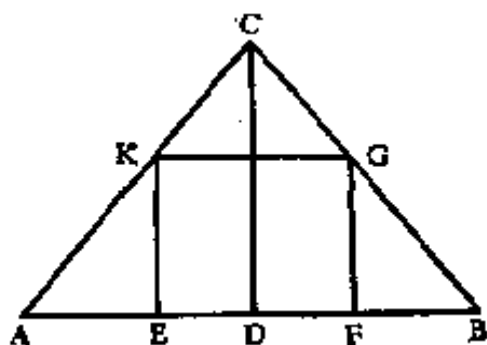
$$\begin{cases} \frac{\partial F}{\partial x} = yz - \frac{\lambda H x}{\sqrt{x^2 + y^2}} = 0, & (1) \\ \frac{\partial F}{\partial y} = xz - \frac{\lambda H y}{\sqrt{x^2 + y^2}} = 0, & (2) \\ \frac{\partial F}{\partial z} = xy - \lambda R = 0, & (3) \\ (H - z) R = H \sqrt{x^2 + y^2}. & (4) \end{cases}$$

由(1)、(2)得 $x=y$, 代入(3), 得 $x=y=\sqrt{\lambda R}$.

又由(1)可得 $z = \frac{\lambda H}{\sqrt{2\lambda R}}$. 将 x, y, z 代入(4)得

$$H = \frac{\lambda H}{\sqrt{2\lambda R}} = \frac{H}{R} \sqrt{2\lambda R},$$

解之得 $\lambda = \frac{2}{9}R$, 从而有

$$x = y = \frac{\sqrt{2}}{3}R, z = \frac{1}{3}H, V = \frac{\sqrt{2}}{36}R^2H.$$

显然, 在所论区域的边界上 (即 $x \rightarrow +0$ 或 $y \rightarrow +0$ 或 $z \rightarrow +0$ 时), 有 $V \rightarrow 0$, 故当直角平行六面

体的高等于 $\frac{1}{3}$ 圆锥的高时, 其体积最大.

3696. 在椭球

$$\frac{x^2}{a^2} + \frac{y^2}{b^2} + \frac{z^2}{c^2} = 1$$

内嵌入有最大体积的直角平行六面体.

解 此直角平行六面体的对称中心为原点, 设其一个顶点为 (x, y, z) , 则按题意, 我们应考虑函数 $V =$

$8xyz$ 在条件 $\frac{x^2}{a^2} + \frac{y^2}{b^2} + \frac{z^2}{c^2} = 1$ ($x > 0, y > 0,$

$z > 0$) 下的极值. 为计算简单计, 略去常数 8. 设 F

$= xyz - \lambda \left(\frac{x^2}{a^2} + \frac{y^2}{b^2} + \frac{z^2}{c^2} - 1 \right)$. 解方程组

$$\begin{cases} \frac{\partial F}{\partial x} = yz - 2\lambda \cdot \frac{x}{a^2} = 0, \\ \frac{\partial F}{\partial y} = xz - 2\lambda \cdot \frac{y}{b^2} = 0, \\ \frac{\partial F}{\partial z} = xy - 2\lambda \cdot \frac{z}{c^2} = 0, \\ \frac{x^2}{a^2} + \frac{y^2}{b^2} + \frac{z^2}{c^2} = 1 \end{cases}$$

得 $x = \frac{a}{\sqrt{3}}$, $y = \frac{b}{\sqrt{3}}$, $z = \frac{c}{\sqrt{3}}$, 这时 $V = \frac{8}{3\sqrt{3}} \cdot abc > 0$.

现在讨论边界情况. 当 $x \rightarrow a - 0$, $y \rightarrow b - 0$, $z \rightarrow c - 0$ 中有任一个成立时, 则另两个变量必皆趋于零; 又若 x, y, z 中有一个趋于零时, 则体积 V 趋于零. 总之, 在边界上, 恒有 $V \rightarrow 0$. 于是, 具有最大体积的直角平行六面体的长、宽、高分别为 $\frac{2a}{\sqrt{3}}$, $\frac{2b}{\sqrt{3}}$, $\frac{2c}{\sqrt{3}}$.

3697. 直圆锥的母线 l 与底平面成倾角 α . 试在此直圆锥中嵌入具最大全表面积的直角平行六面体.

解 设圆锥的底半径为 R , 高为 H , 则有 $R = l \cos \alpha$, $H = l \sin \alpha$, $\frac{H}{R} = \operatorname{tg} \alpha$. 内接长方体的放置方法与 3695 题相同. 设底面的两边分别为 $2d \cos \theta$ 和 $2d \sin \theta$, 高为 h , 则 $0 < d < R$, $0 < h < H$, $0 < \theta < \frac{\pi}{2}$, 且 h ,

d 由条件 $\frac{H-h}{H} = \frac{d}{R}$ 约束, 此条件可改写为

$$d \cdot \operatorname{tg} \alpha + h = H = l \sin \alpha.$$

所求的全表面积为

$$S = 4(d^2 \sin 2\theta + dh \sin \theta + dh \cos \theta).$$

(i) 固定 d 和 h , 考虑 $S = S(\theta)$ 的变化情况. 由一元函数极值求法, 不难断定, 仅有 $S'(\frac{\pi}{4}) = 0$.

$S(\theta)$ 在 $\frac{\pi}{4}$ 处达到最大值 $S = 4(d^2 + \sqrt{2}dh)$, 即底面为正方形时, S 才取得最大值. 因此, 原问题可化为在条件 $d \cdot \operatorname{tg} \alpha + h = l \sin \alpha$ ($d > 0, h > 0$) 下, 求函数 $S = 4(d^2 + \sqrt{2}dh)$ 的极值.

(ii) 此问题的边界值: 当 $d \rightarrow +0$ (此时 $h \rightarrow H - 0$) 时, 显然 $S \rightarrow 0$; 而当 $h \rightarrow +0$ (这时 $d \rightarrow R - 0$) 时, $S \rightarrow 4R^2$. 在后一种情况下, 全表面积退化为上、下两个正方形面积之和.

(iii) 在区域内部, 设

$$F = 4(d^2 + \sqrt{2}dh) - \lambda(d \cdot \operatorname{tg} \alpha + h - l \sin \alpha).$$

解方程组

$$\begin{cases} \frac{\partial F}{\partial d} = 8d + 4\sqrt{2}h - \lambda \operatorname{tg} \alpha = 0, & (1) \end{cases}$$

$$\begin{cases} \frac{\partial F}{\partial h} = 4\sqrt{2}d - \lambda = 0, & (2) \end{cases}$$

$$\begin{cases} d \cdot \operatorname{tg} \alpha + h = l \sin \alpha. & (3) \end{cases}$$

由 (2) 得 $\lambda = 4\sqrt{2}d$, 代入 (1), 得

$$h = (\operatorname{tg} \alpha - \sqrt{2})d. \quad (4)$$

由 $h > 0$ 及 $d > 0$ 知, 当 $\operatorname{tg} \alpha \leq \sqrt{2}$ 时, 方程组在所研究的区域内无解. 此时, S 的最大值必在边界上达到, 即在 $h \rightarrow +0$ 时达到 $4R^2$. 当 $\operatorname{tg} \alpha > \sqrt{2}$ 时, 将 (4) 式代入 (3) 式, 可得

$$d = \frac{l \sin \alpha}{2 \operatorname{tg} \alpha - \sqrt{2}}, \quad h = l \sin \alpha \cdot \frac{\operatorname{tg} \alpha - \sqrt{2}}{2 \operatorname{tg} \alpha - \sqrt{2}}.$$

此时

$$S = 4(d^2 + \sqrt{2} dh) = \frac{2l^2 \sin^2 \alpha}{\sqrt{2} \operatorname{tg} \alpha - 1} = \frac{2R^2 \operatorname{tg}^2 \alpha}{\sqrt{2} \operatorname{tg} \alpha - 1}.$$

由于 $(\operatorname{tg} \alpha - \sqrt{2})^2 = \operatorname{tg}^2 \alpha - 2(\sqrt{2} \operatorname{tg} \alpha - 1) > 0$, 故 $\frac{\operatorname{tg}^2 \alpha}{\sqrt{2} \operatorname{tg} \alpha - 1} > 2$. 从而, $S > 4R^2$, 即在该点的值大于

边界上的值. 因此, 它为最大值. 于是, 当 $\operatorname{tg} \alpha > \sqrt{2}$,

长方体底面为正方形, 边长为 $2d \sin \frac{\pi}{4} = \frac{l \sin \alpha}{\sqrt{2} \operatorname{tg} \alpha - 1}$,

高 $h = l \sin \alpha \cdot \frac{\operatorname{tg} \alpha - \sqrt{2}}{2 \operatorname{tg} \alpha - \sqrt{2}}$ 时, 全表面积为最大.

3698. 在椭圆抛物面 $\frac{z}{c} = \frac{x^2}{a^2} + \frac{y^2}{b^2}$, $z = c$ 的一段中嵌入有最大体积的直角平行六面体.

解 设长方体的长、宽、高为 $2x$, $2y$ 及 $h = c - z$, 则

按题设考虑函数 $V = 4xyh = 4xy(c - z)$ 在条件 $\frac{x^2}{a^2} + \frac{y^2}{b^2} = \frac{z}{c}$ ($x > 0$, $y > 0$, $0 < z < c$) 下的极值. 为

计算简单起见, 作 F 时略去常数 4. 令 $F = xy(c - z)$

$$- \lambda \left(\frac{x^2}{a^2} + \frac{y^2}{b^2} - \frac{z}{c} \right).$$

解方程组

$$\left\{ \begin{array}{l} \frac{\partial F}{\partial x} = y(c-z) - 2\lambda \cdot \frac{x}{a^2} = 0, \quad (1) \\ \frac{\partial F}{\partial y} = x(c-z) - 2\lambda \cdot \frac{y}{b^2} = 0, \quad (2) \\ \frac{\partial F}{\partial z} = -xy + \frac{\lambda}{c} = 0, \quad (3) \\ \frac{x^2}{a^2} + \frac{y^2}{b^2} = \frac{z}{c}. \quad (4) \end{array} \right.$$

将(1)、(2)、(3)三式分别乘以 x 、 y 、 $(c-z)$,

比较即得 $\frac{x^2}{a^2} = \frac{y^2}{b^2} = \frac{c-z}{2c}$. 代入(4)式, 可得

$$x = \frac{a}{2}, \quad y = \frac{b}{2}, \quad z = \frac{c}{2}, \quad h = c - z = \frac{c}{2}.$$

由于边界上 V 趋于零, 故长方体的最大值必在区域内达到. 于是, 当平行六面体的尺寸为 a 、 b 及 $\frac{c}{2}$ 时, 其体积最大.

3699. 求点 $M_0(x_0, y_0, z_0)$ 至平面 $Ax + By + Cz + D = 0$ 的最短距离.

解 按题设, 我们应求函数

$$r^2 = (x - x_0)^2 + (y - y_0)^2 + (z - z_0)^2$$

在条件 $Ax + By + Cz + D = 0$ 下的极值. 设

$$F(x, y, z) = r^2 + \lambda(Ax + By + Cz + D).$$

解方程组

$$\left\{ \begin{array}{l} \frac{\partial F}{\partial x} = 2(x-x_0) + \lambda A = 0, \\ \frac{\partial F}{\partial y} = 2(y-y_0) + \lambda B = 0, \\ \frac{\partial F}{\partial z} = 2(z-z_0) + \lambda C = 0, \\ Ax + By + Cz + D = 0. \end{array} \right. \quad (1)$$

$$\frac{\partial F}{\partial y} = 2(y-y_0) + \lambda B = 0, \quad (2)$$

$$\frac{\partial F}{\partial z} = 2(z-z_0) + \lambda C = 0, \quad (3)$$

$$Ax + By + Cz + D = 0. \quad (4)$$

由 (1), (2), (3) 可得

$$x = x_0 - \frac{1}{2}\lambda A, \quad y = y_0 - \frac{1}{2}\lambda B, \quad z = z_0 - \frac{1}{2}\lambda C. \quad (5)$$

代入 (4), 得

$$\lambda = \frac{2(Ax_0 + By_0 + Cz_0 + D)}{A^2 + B^2 + C^2}, \quad (6)$$

将 (5), (6) 代入 $r^2 = (x-x_0)^2 + (y-y_0)^2 + (z-z_0)^2$ 中, 得

$$r = \frac{|Ax_0 + By_0 + Cz_0 + D|}{\sqrt{A^2 + B^2 + C^2}}.$$

当 x, y, z 中有任一个趋于无穷时, r 趋于无穷. 因此, 在区域内 r 必取最小值.

于是, 点 $M_0(x_0, y_0, z_0)$ 至平面 $Ax + By + Cz + D = 0$ 的最短距离为

$$r = \frac{|Ax_0 + By_0 + Cz_0 + D|}{\sqrt{A^2 + B^2 + C^2}}.$$

3700. 求空间二直线

$$\text{和} \quad \frac{x-x_1}{m_1} = \frac{y-y_1}{n_1} = \frac{z-z_1}{p_1}$$

$$\frac{x-x_2}{m_2} = \frac{y-y_2}{n_2} = \frac{z-z_2}{p_2}$$

之间的最短距离.

解 显然, 当两直线不平行时, 直线上一点趋于无穷远处时, 与另一直线上各点的距离, 都趋于无穷. 因此, 不平行两直线的最短距离必在有限处达到.

为了书写简洁, 我们采用向量的表达形式. 用

$$\vec{r}_1(t) = \vec{l}_1 t + \vec{r}_{10} \text{ 表示直线 } \frac{x-x_1}{m_1} = \frac{y-y_1}{n_1} = \frac{z-z_1}{p_1}, \quad (1)$$

$$\vec{r}_2(s) = \vec{l}_2 s + \vec{r}_{20} \text{ 表示直线 } \frac{x-x_2}{m_2} = \frac{y-y_2}{n_2} = \frac{z-z_2}{p_2}, \quad (2)$$

其中 t, s 为参数, $\vec{l}_1 = \{m_1, n_1, p_1\}$, $\vec{l}_2 = \{m_2, n_2, p_2\}$,
 $\vec{r}_{10} = \{x_1, y_1, z_1\}$, $\vec{r}_{20} = \{x_2, y_2, z_2\}$.

又记

$$\vec{r}_0 = \vec{r}_{10} - \vec{r}_{20} = \{x_1 - x_2, y_1 - y_2, z_1 - z_2\}.$$

始端在直线 (2) 上, 终端在直线 (1) 上的向量为:

$$\begin{aligned} \vec{u}(t, s) &= (\vec{l}_1 t + \vec{r}_{10}) - (\vec{l}_2 s + \vec{r}_{20}) \\ &= \vec{l}_1 t - \vec{l}_2 s + \vec{r}_0. \end{aligned} \quad (3)$$

本题即求 $|\vec{u}(t, s)|$ 的最小值, 它必在有限的 t, s 上取得. 令

$$\begin{aligned} w &= |\vec{u}(t, s)|^2 = |\vec{l}_1 t - \vec{l}_2 s + \vec{r}_0|^2 \\ &= l_1^2 t^2 + l_2^2 s^2 + r_0^2 - 2(\vec{l}_1 \cdot \vec{l}_2)st + 2(\vec{l}_1 \cdot \vec{r}_0)t \\ &\quad - 2(\vec{l}_2 \cdot \vec{r}_0)s, \end{aligned}$$

其中 $l_1^2 = \vec{l}_1 \cdot \vec{l}_1$, $l_2^2 = \vec{l}_2 \cdot \vec{l}_2$, $r_0^2 = \vec{r}_0 \cdot \vec{r}_0$.

w 取得极值的必要条件为

$$\frac{\partial w}{\partial t} = 2[l_1^2 t - (\vec{l}_1 \cdot \vec{l}_2) s + (\vec{l}_1 \cdot \vec{r}_0)] = 0,$$

$$\frac{\partial w}{\partial s} = 2[l_2^2 s - (\vec{l}_1 \cdot \vec{l}_2) t - (\vec{l}_2 \cdot \vec{r}_0)] = 0.$$

由此可解得唯一的静止点 (t_0, s_0) :

$$t_0 = -\frac{l_2^2 (\vec{l}_1 \cdot \vec{r}_0) - (\vec{l}_1 \cdot \vec{l}_2) (\vec{l}_2 \cdot \vec{r}_0)}{l_1^2 l_2^2 - (\vec{l}_1 \cdot \vec{l}_2)^2},$$

$$s_0 = \frac{l_1^2 (\vec{l}_2 \cdot \vec{r}_0) - (\vec{l}_1 \cdot \vec{l}_2) (\vec{l}_1 \cdot \vec{r}_0)}{l_1^2 l_2^2 - (\vec{l}_1 \cdot \vec{l}_2)^2}.$$

于是 $|\vec{u}(t_0, s_0)|$ 即为所求的最短距离. 下面计算 $|\vec{u}(t_0,$

$s_0)|$. 令 $\Delta = \sqrt{l_1^2 l_2^2 - (\vec{l}_1 \cdot \vec{l}_2)^2}$, 显然有

$$\begin{aligned} \Delta^2 &= |\vec{l}_1|^2 \cdot |\vec{l}_2|^2 - [|\vec{l}_1| \cdot |\vec{l}_2| \cos(\widehat{\vec{l}_1, \vec{l}_2})]^2 \\ &= |\vec{l}_1|^2 \cdot |\vec{l}_2|^2 \sin^2(\widehat{\vec{l}_1, \vec{l}_2}) = |\vec{l}_1 \times \vec{l}_2|^2, \end{aligned}$$

即

$$\Delta = |\vec{l}_1 \times \vec{l}_2|.$$

将 t_0 及 s_0 代入 (3) 式, 得

$$\begin{aligned} \vec{u}(t_0, s_0) &= -\frac{1}{\Delta^2} (\vec{l}_1 \cdot \vec{r}_0) [l_2^2 \vec{l}_1 - (\vec{l}_1 \cdot \vec{l}_2) \vec{l}_2] \\ &\quad - \frac{1}{\Delta^2} (\vec{l}_2 \cdot \vec{r}_0) [l_1^2 \vec{l}_2 - (\vec{l}_1 \cdot \vec{l}_2) \vec{l}_1] + \vec{r}_0. \end{aligned}$$

通过计算, 不难得出

$$\begin{aligned} \vec{u}(t_0, s_0) \cdot \vec{l}_1 &= -\frac{1}{\Delta^2} (\vec{l}_1 \cdot \vec{r}_0) [l_2^2 l_1^2 - (\vec{l}_1 \cdot \vec{l}_2)^2] - \frac{1}{\Delta^2} \\ &\quad \cdot (\vec{l}_2 \cdot \vec{r}_0) [l_1^2 (\vec{l}_1 \cdot \vec{l}_2) - (\vec{l}_1 \cdot \vec{l}_2) l_1^2] + (\vec{r}_0 \cdot \vec{l}_1) = 0, \end{aligned}$$

$$\vec{u}(t_0, s_0) \cdot \vec{l}_2 = 0.$$

因此, 得知

$$\vec{u}(t_0, s_0) \parallel \vec{l}_1 \times \vec{l}_2.$$

$$\text{令 } \vec{n}_0 = \frac{\vec{l}_1 \times \vec{l}_2}{\Delta}, \text{ 则 } |\vec{n}_0| = 1,$$

$$|\vec{u}(t_0, s_0)| = |\vec{u}(t_0, s_0) \cdot \vec{n}_0| = \frac{|\vec{r}_2 \cdot (\vec{l}_1 \times \vec{l}_2)|}{\Delta}$$

$$= \pm \frac{1}{\Delta} \begin{vmatrix} x_1 - x_2 & y_1 - y_2 & z_1 - z_2 \\ m_1 & n_1 & p_1 \\ m_2 & n_2 & p_2 \end{vmatrix},$$

其中

$$\Delta = \sqrt{\begin{vmatrix} m_1 & n_1 \\ m_2 & n_2 \end{vmatrix}^2 + \begin{vmatrix} m_1 & p_1 \\ n_2 & p_2 \end{vmatrix}^2 + \begin{vmatrix} p_1 & m_1 \\ p_2 & m_2 \end{vmatrix}^2},$$

且正负号的选取保证所得结果为正值。

2701. 求抛物线 $y = x^2$ 和直线 $x - y - 2 = 0$ 之间的最短距离。

解 设 (x_1, y_1) 为抛物线 $y = x^2$ 上任一点, (x_2, y_2) 为直线 $x - y - 2 = 0$ 上的任一点. 按题意, 我们应求函数

$$r^2 = (x_2 - x_1)^2 + (y_2 - y_1)^2$$

在条件 $y_1 - x_1^2 = 0$ 及 $x_2 - y_2 - 2 = 0$ 下的极值. 显然, 由几何知, 当两点 (x_1, y_1) 和 (x_2, y_2) 至少有一伸向无穷时, r 也必趋于无穷大, 故 r 的最小值必在有限处达到.

设 $F(x_1, x_2, y_1, y_2) = r^2 + \lambda_1(y_1 - x_1^2) + \lambda_2(x_2 - y_2 - 2)$

- 2).

解方程组

$$\begin{cases} \frac{\partial F}{\partial x_1} = -2(x_2 - x_1) - 2\lambda_1 x_1 = 0, \\ \frac{\partial F}{\partial x_2} = 2(x_2 - x_1) + \lambda_2 = 0, \\ \frac{\partial F}{\partial y_1} = -2(y_2 - y_1) + \lambda_1 = 0, \\ \frac{\partial F}{\partial y_2} = 2(y_2 - y_1) - \lambda_2 = 0, \\ y_1 = x_1^2, \\ x_2 - y_2 - 2 = 0. \end{cases}$$

得唯一的一组解 $x_1 = \frac{1}{2}$, $y_1 = \frac{1}{4}$; $x_2 = \frac{11}{8}$, $y_2 = -\frac{5}{8}$.

于是, 所求的最短距离为

$$r_0 = \sqrt{\left(\frac{11}{8} - \frac{1}{2}\right)^2 + \left(-\frac{5}{8} - \frac{1}{4}\right)^2} = \frac{7}{8}\sqrt{2}.$$

3702. 求有心二次曲线

$$Ax^2 + 2Bxy + Cy^2 = 1$$

的半轴.

解 设 (x_0, y_0) 为二次曲线 $Ax^2 + 2Bxy + Cy^2 = 1$ 上的点, 则 $(-x_0, -y_0)$ 也为该曲线上的点. 因此, 原点 $(0, 0)$ 即为曲线的中心. 按题意, 应求函数 $u = x^2 + y^2$ 在条件 $Ax^2 + 2Bxy + Cy^2 = 1$ 下的极值. 设 $F = x^2 + y^2 - \lambda(Ax^2 + 2Bxy + Cy^2 - 1)$.

解方程组

$$\begin{cases} -\frac{1}{2} \frac{\partial F}{\partial x} = (\lambda A - 1)x + \lambda B y = 0, \\ -\frac{1}{2} \frac{\partial F}{\partial y} = \lambda B x + (\lambda C - 1)y = 0, \\ Ax^2 + 2Bxy + Cy^2 = 1. \end{cases}$$

要方程组有非零解, λ 必须满足二次方程

$$\begin{vmatrix} \lambda A - 1 & \lambda B \\ \lambda B & \lambda C - 1 \end{vmatrix} = 0. \quad (1)$$

由题设知二次曲线为有心的, 因此 $AC^2 - B^2 \neq 0$.

由方程 (1) 可求得两根 λ_1 和 λ_2 ($\lambda_1 \geq \lambda_2$). 将 λ 的值代入方程组, 求得对应于 λ_1 的解 (x_1, y_1) 及对应于 λ_2 的解 (x_2, y_2) . 相应地, 有

$$\begin{aligned} u(x_1, y_1) &= x_1^2 + y_1^2 = x_1[\lambda_1(Ax_1 + By_1)] \\ &\quad + y_1[\lambda_1(Bx_1 + Cy_1)] \\ &= \lambda_1(Ax_1^2 + 2Bx_1y_1 + Cy_1^2) = \lambda_1, \end{aligned}$$

同理 $u(x_2, y_2) = x_2^2 + y_2^2 = \lambda_2$.

(i) 当 $AC - B^2 > 0$ 且 $A + C > 0$ (或 $A > 0$) 时, 由 (1) 解得

$$\lambda_i = \frac{(A+C) \pm \sqrt{(A+C)^2 - 4(AC - B^2)}}{2(AC - B^2)} > 0,$$

即有 $\lambda_1 \geq \lambda_2 > 0$. 显然 u 的最大值及最小值必在区域内达到. 因此, λ_1 及 λ_2 分别为 u 的最大值及最小值. 此时, 所对应的曲线为椭圆, 长、短半轴的平方分别为 λ_1 及 λ_2 . 当 $\lambda_1 = \lambda_2$ ($A = C, B = 0$) 时为圆.

当 $A+C < 0$ (或 $A < 0$) 时, 两根 λ_i 均为负, 相应曲线无轨迹.

(ii) 当 $AC - B^2 < 0$ 时, $\lambda_1 > 0$, $\lambda_2 < 0$. 此时只有一个极值 λ_1 . 对应的曲线为双曲线. λ_1 为实半轴的平方 (λ_2 表面上无意义, 但实质上为虚半轴的平方), 其中特别是 $B = 0$ 时, 曲线退化为一对相交直线.

3703. 求有心二次曲面

$$Ax^2 + By^2 + Cz^2 + 2Dxy + 2Eyz + 2Fxz = 1$$

的半轴.

解 同上题可知, 曲面的中心为 $(0, 0, 0)$. 按题意, 达到曲面半轴的点 (x, y, z) 一定是函数 $u(x, y, z) = x^2 + y^2 + z^2$ 在条件

$$Ax^2 + By^2 + Cz^2 + 2Dxy + 2Eyz + 2Fxz = 1$$

下的静止点 (但不一定是极值点. 例如, 椭球面的中间轴所在的点). 设

$$F = u - \lambda(Ax^2 + By^2 + Cz^2 + 2Dxy + 2Eyz + 2Fxz - 1).$$

解方程组

$$\begin{cases} -\frac{1}{2} \frac{\partial F}{\partial x} = (\lambda A - 1)x + \lambda D y + \lambda F z = 0, \\ -\frac{1}{2} \frac{\partial F}{\partial y} = \lambda D x + (\lambda B - 1)y + \lambda E z = 0, \\ -\frac{1}{2} \frac{\partial F}{\partial z} = \lambda F x + \lambda E y + (\lambda C - 1)z = 0, \\ Ax^2 + By^2 + Cz^2 + 2Dxy + 2Eyz + 2Fxz = 1. \end{cases}$$

上述方程组要有非零解， λ 必须满足三次方程

$$\begin{vmatrix} \lambda A - 1 & \lambda D & \lambda F \\ \lambda D & \lambda B - 1 & \lambda E \\ \lambda F & \lambda E & \lambda C - 1 \end{vmatrix} = 0.$$

设三根为 $\lambda_1 \geq \lambda_2 \geq \lambda_3$ ，对应于此三根可求出满足方程组的静止点。与3702题相同，可证明在这些静止点处 $u(x, y, z)$ 的值恰为 λ_i ($i=1, 2, 3$)，即 λ_i 为曲面半轴的平方（严格地说，当 $\lambda_i < 0$ 时不能认为它是半轴的平方）。

与二次曲线的情况类似，根据 λ_i 的正负可讨论曲面半轴的虚、实等问题，这对熟悉二次曲面分类的读者无实质性的困难，因此省略掉这些烦琐的讨论。

3704. 求用平面

$$Ax + By + Cz = 0$$

与圆柱

$$\frac{x^2}{a^2} + \frac{y^2}{b^2} = 1$$

相交所成椭圆的面积。

解 我们只要确定所得椭圆的长短半轴 \bar{a} 及 \bar{b} ，即可按公式 $S = \pi \bar{a} \bar{b}$ 求得椭圆的面积。

注意到原点 $(0, 0, 0)$ 在原圆柱面的中心轴上，且截平面 $Ax + By + Cz = 0$ 又通过它，因此，原点是截线椭圆的中心，从而长短半轴 \bar{a} 及 \bar{b} 的平方 \bar{a}^2 及 \bar{b}^2 ，分别为函数 $u = x^2 + y^2 + z^2$ 在条件 $Ax + By + Cz = 0$ 及 $\frac{x^2}{a^2} + \frac{y^2}{b^2} = 1$ 下的最大值和最小值。设

$$F = u + 2\lambda(Ax + By + Cz) - \mu\left(\frac{x^2}{a^2} + \frac{y^2}{b^2} - 1\right).$$

于是,达到最大值、最小值的点的坐标必须满足方程组

$$\begin{cases} \frac{1}{2} \frac{\partial F}{\partial x} = \left(1 - \frac{\mu}{a^2}\right)x + \lambda A = 0, & (1) \end{cases}$$

$$\begin{cases} \frac{1}{2} \frac{\partial F}{\partial y} = \left(1 - \frac{\mu}{b^2}\right)y + \lambda B = 0, & (2) \end{cases}$$

$$\begin{cases} \frac{1}{2} \frac{\partial F}{\partial z} = z + \lambda C = 0, & (3) \end{cases}$$

$$\begin{cases} Ax + By + Cz = 0, & (4) \end{cases}$$

$$\begin{cases} \frac{x^2}{a^2} + \frac{y^2}{b^2} = 1. & (5) \end{cases}$$

将(1)、(2)、(3)三式分别乘以 x 、 y 、 z 后,然后相加,得 $x^2 + y^2 + z^2 = \mu$,即从方程组可解得

$u(x, y, z) = \mu$. 由(1)、(2)、(3)、(4)知,若要 x, y, z 及 λ 不全为零, μ 必须满足下列方程(同时 μ 只要满足下列方程,静止点 (x, y, z) 也一定有解):

$$\begin{vmatrix} 1 - \frac{\mu}{a^2} & 0 & 0 & A \\ 0 & 1 - \frac{\mu}{b^2} & 0 & B \\ 0 & 0 & 1 & C \\ A & B & C & 0 \end{vmatrix} = 0.$$

展开后,得

$$\begin{aligned} \frac{C^2}{a^2 b^2} \mu^2 - \left(\frac{B^2}{a^2} + \frac{A^2}{b^2} + \frac{C^2}{a^2} + \frac{C^2}{b^2} \right) \mu \\ + (A^2 + B^2 + C^2) = 0. \end{aligned}$$

此方程有两正根，显然即为最大值及最小值 \bar{a}^2 、 \bar{b}^2 ，由韦达定理知

$$\frac{\bar{a}^2 \bar{b}^2}{a^2 b^2} = \frac{a^2 b^2 (A^2 + B^2 + C^2)}{C^2},$$

故椭圆面积 $\pi \bar{a} \bar{b} = \frac{\pi ab \sqrt{A^2 + B^2 + C^2}}{|C|}$ ($C \neq 0$).

当 $C=0$ 时，平面 $Ax + By = 0$ 过 Oz 轴，显然得不到椭圆截面。

3705. 求用平面

$$x \cos \alpha + y \cos \beta + z \cos \gamma = 0$$

(其中 $\cos^2 \alpha + \cos^2 \beta + \cos^2 \gamma = 1$)与椭球面

$$\frac{x^2}{a^2} + \frac{y^2}{b^2} + \frac{z^2}{c^2} = 1$$

相截所成截面的面积。

解 截面为一椭圆。与3704题一样，我们只要先考虑函数 $u = x^2 + y^2 + z^2$ 在条件

$$x \cos \alpha + y \cos \beta + z \cos \gamma = 0 \text{ 及 } \frac{x^2}{a^2} + \frac{y^2}{b^2} + \frac{z^2}{c^2} = 1$$

下的极值 ($a > 0$, $b > 0$, $c > 0$)。设

$$F = u + 2\lambda_1(x \cos \alpha + y \cos \beta + z \cos \gamma) - \lambda_2 \left(\frac{x^2}{a^2} + \frac{y^2}{b^2} + \frac{z^2}{c^2} - 1 \right).$$

解方程组

$$\begin{cases} \frac{1}{2} \frac{\partial F}{\partial x} = \left(1 - \frac{\lambda_2}{a^2}\right)x + \lambda_1 \cos \alpha = 0, & (1) \\ \frac{1}{2} \frac{\partial F}{\partial y} = \left(1 - \frac{\lambda_2}{b^2}\right)y + \lambda_1 \cos \beta = 0, & (2) \\ \frac{1}{2} \frac{\partial F}{\partial z} = \left(1 - \frac{\lambda_2}{c^2}\right)z + \lambda_1 \cos \gamma = 0, & (3) \\ x \cos \alpha + y \cos \beta + z \cos \gamma = 0, & (4) \\ \frac{x^2}{a^2} + \frac{y^2}{b^2} + \frac{z^2}{c^2} = 1. & (5) \end{cases}$$

将(1), (2), (3)三式分别乘以 x, y, z ,然后相加,即得

$$u = x^2 + y^2 + z^2 = \lambda_2.$$

由(1)、(2)、(3)、(4)知,若要 x, y, z 及 λ_1 不全为零, λ_2 必须满足下列方程

$$\begin{vmatrix} 1 - \frac{\lambda_2}{a^2} & 0 & 0 & \cos \alpha \\ 0 & 1 - \frac{\lambda_2}{b^2} & 0 & \cos \beta \\ 0 & 0 & 1 - \frac{\lambda_2}{c^2} & \cos \gamma \\ \cos \alpha & \cos \beta & \cos \gamma & 0 \end{vmatrix} = 0.$$

展开整理得

$$\begin{aligned} & \left(\frac{\cos^2 \alpha}{b^2 c^2} + \frac{\cos^2 \beta}{c^2 a^2} + \frac{\cos^2 \gamma}{a^2 b^2} \right) \lambda_2^2 - \left(\frac{\cos^2 \alpha}{b^2} + \frac{\cos^2 \alpha}{c^2} \right. \\ & \left. + \frac{\cos^2 \beta}{c^2} + \frac{\cos^2 \beta}{a^2} + \frac{\cos^2 \gamma}{a^2} + \frac{\cos^2 \gamma}{b^2} \right) \lambda_2 + 1 = 0. \end{aligned}$$

此方程有两正根，显然即为椭圆的长短半轴的平方 \bar{a}^2 、 \bar{b}^2 ，由韦达定理知

$$\frac{\bar{a}^2 \bar{b}^2}{a^2 b^2} = \frac{a^2 b^2 c^2}{a^2 \cos^2 \alpha + b^2 \cos^2 \beta + c^2 \cos^2 \gamma}.$$

于是，所求椭圆的面积为

$$S = \pi \bar{a} \bar{b} = \frac{\pi abc}{\sqrt{a^2 \cos^2 \alpha + b^2 \cos^2 \beta + c^2 \cos^2 \gamma}}.$$

3706. 根据费耳马原则，从 A 点射出而达于 B 点的光线，沿着需要最短时间的曲线传播。

假定点 A 和点 B 位于以平面所分开的不同的光介质中，并且光传播的速度在第一介质中等于 v_1 ，而在第二介质中等于 v_2 ，推出光的折射定律。

解 如图 6.45 所示，光线从 A 点射出，沿着折线 AMB 到达 B 点。由 A 、 B 作垂直于 l 的直线 AC 及 BD ，并与直线 l 交于 C 点及 D 点。设 $AC = a$ ， $BD = b$ ， $CD = d$ 。选择角度 α, β 为变量，则



图 6.45

$$AM = \frac{a}{\cos \alpha}, \quad BM = \frac{b}{\cos \beta},$$

$$CM = a \operatorname{tg} \alpha, \quad MD = b \operatorname{tg} \beta.$$

于是，我们的问题就是求函数

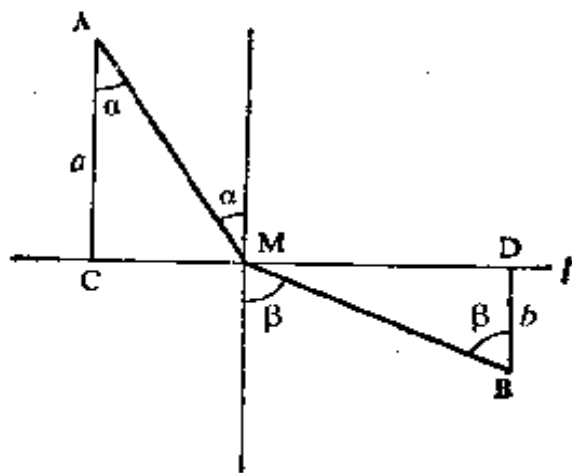
$$f(\alpha, \beta) = \frac{a}{v_1 \cos \alpha} + \frac{b}{v_2 \cos \beta}$$

在条件 $a \operatorname{tg} \alpha + b \operatorname{tg} \beta = d$ 下的最小值, 其中 $-\frac{\pi}{2} < \alpha < \frac{\pi}{2}$, $-\frac{\pi}{2} < \beta < \frac{\pi}{2}$ (当 M 在 C 与 D 之间时, $\alpha > 0$, $\beta > 0$; 当 M 在 C 点的左边时, $\alpha < 0$, $\beta > 0$; 当 M 在点 D 的右边时, $\alpha > 0$, $\beta < 0$). 显然 $f(\alpha, \beta)$ 是连续函数; 又当 $\alpha \rightarrow \frac{\pi}{2} - 0$ 时 (这时点 M 从右边伸向无穷远, $\beta \rightarrow -\frac{\pi}{2} + 0$), 显然 $f(\alpha, \beta) \rightarrow +\infty$; 当 $\alpha \rightarrow -\frac{\pi}{2} + 0$ 时 (这时点 M 从左边伸向无穷远, $\beta \rightarrow \frac{\pi}{2} - 0$), 显然也有 $f(\alpha, \beta) \rightarrow +\infty$. 由此可知 $f(\alpha, \beta)$ 在有限处达到最小值, 此处必为静止点. 设

$$F = \frac{a}{v_1 \cos \alpha} + \frac{b}{v_2 \cos \beta} - \lambda(a \operatorname{tg} \alpha + b \operatorname{tg} \beta - d).$$

注意到由

$$\begin{cases} \frac{\partial F}{\partial \alpha} = \frac{a \sin \alpha}{v_1 \cos^2 \alpha} - \frac{\lambda a}{\cos^2 \alpha} = 0, \\ \frac{\partial F}{\partial \beta} = \frac{b \sin \beta}{v_2 \cos^2 \beta} - \frac{\lambda b}{\cos^2 \beta} = 0, \end{cases}$$

即得

$$\frac{\sin \alpha}{v_1} = \lambda, \quad \frac{\sin \beta}{v_2} = \lambda.$$

于是, 在静止点必满足

$$\frac{\sin \alpha}{\sin \beta} = \frac{v_1}{v_2}.$$

由此可知，光的传播路径必满足上面的关系。这就是著名的光线折射定律。此时，由点 A 到点 B 的光线传播所需要的时间最短。

3707. 当投射角怎样时，光线的折射（即投射线与出射线之间的角）为最小？

（此光线经过棱镜的折射角为 α ，折射系数为 n ）。求出此最小的折射。

解 如图 6.46 所示， ABC 为棱镜。 $\angle BAC = \alpha$ 为棱镜顶角（即



图 6.46

棱镜的折射角)， DE 为入射光线，折射后从 F 点折射出棱镜，射出线为 FG 。 IH 和 JH 分别为入射点和射出点的法线，它们相交于 H ($IH \perp AC$, $JH \perp AB$)。入射线 DE 的延长线 DM 与射出线的反向延长线 FL 交于 K 。令 $\angle DEI = \beta$, $\angle GFJ = \gamma$, $\angle GKM = \delta$, $\angle HEF = \lambda$, $\angle EFH = \mu$ 。

按题意即问：当 β 在 $(0, \frac{\pi}{2})$ 之间的一定范围内变化时， δ 何时达到极小值。这本是一元函数的极值问题，然因牵涉的变量关系太多，因此把它看作多元函数的条件极值问题。

由折射定律（3706题）可知：

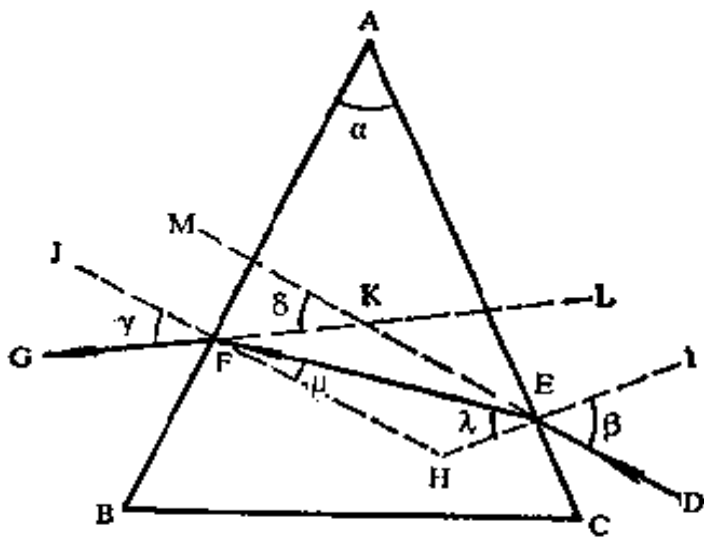
$$\sin\beta = n\sin\lambda, \quad (1)$$

$$\sin\gamma = n\sin\mu. \quad (2)$$

由几何关系不难求出 $\alpha, \beta, \gamma, \delta, \lambda$ 及 μ 之间的关系:

$$\lambda + \mu = \alpha, \quad (3)$$

$$\delta = \beta + \gamma - \alpha. \quad (4)$$

由于 α 为常数, 故从 (1)、(2)、(3)、(4) 四式中消去 λ, μ 及 γ 就得到 δ 作为 β 的函数. 令

$$F(\beta, \gamma, \lambda, \mu) = \beta + \gamma - \alpha + k_1(\sin\beta - n\sin\lambda) \\ + k_2(n\sin\mu - \sin\gamma) + k_3(\lambda + \mu - \alpha).$$

静止点适合下列方程组

$$\left\{ \begin{array}{l} \frac{\partial F}{\partial \beta} = 1 + k_1 \cos\beta = 0, \end{array} \right. \quad (5)$$

$$\left\{ \begin{array}{l} \frac{\partial F}{\partial \gamma} = 1 - k_2 \cos\gamma = 0, \end{array} \right. \quad (6)$$

$$\left\{ \begin{array}{l} \frac{\partial F}{\partial \lambda} = -k_1 n \cos\lambda + k_3 = 0, \end{array} \right. \quad (7)$$

$$\left\{ \begin{array}{l} \frac{\partial F}{\partial \mu} = k_2 n \cos\mu + k_3 = 0. \end{array} \right. \quad (8)$$

由 (7)、(8) 消去 k_3 , 得 $k_1 \cos\lambda = -k_2 \cos\mu$. (9)

由 (5)、(6) 得 $k_1 = -\frac{1}{\cos\beta}$, $k_2 = \frac{1}{\cos\gamma}$. 代入 (9),

两边平方, 即得

$$\frac{\cos^2\lambda}{\cos^2\beta} = \frac{\cos^2\mu}{\cos^2\gamma} \text{ 或 } \frac{1 - \sin^2\lambda}{1 - \sin^2\beta} = \frac{1 - \sin^2\mu}{1 - \sin^2\gamma}. \quad (10)$$

将 (1)、(2) 代入 (10), 得

$$\frac{1 - \sin^2\lambda}{1 - n^2 \sin^2\lambda} = \frac{1 - \sin^2\mu}{1 - n^2 \sin^2\mu}$$

整理后得

$$(n^2 - 1)(\sin^2 \lambda - \sin^2 \mu) = 0.$$

由于 $0 < \lambda < \frac{\pi}{2}$, $0 < \mu < \frac{\pi}{2}$, 故 $\sin \lambda = \sin \mu$ 或 $\lambda = \mu$.

代入(3), 得 $\lambda = \mu = \frac{\alpha}{2}$. 从而 $\beta = \gamma = \arcsin\left(n \sin \frac{\alpha}{2}\right)$.

于是,

$$\delta = \beta + \gamma - \alpha = 2 \arcsin\left(n \sin \frac{\alpha}{2}\right) - \alpha.$$

所求得的 β 即为唯一的静止点.

根据物理知识, 作为本题所讨论的对象: 顶角较小的分光棱镜, 在区域内确实存在着最小的折射. 于是,

当入射角

$$\beta = \arcsin\left(n \sin \frac{\alpha}{2}\right)$$

时, 则

$$\delta = 2 \arcsin\left(n \sin \frac{\alpha}{2}\right) - \alpha$$

应为最小折射. 至于作其它用途的各种棱镜, 光线的折射路径不仅与顶角有关, 而且大都与整个棱镜的构造有关, 这已不属于本题所考虑的对象, 因而也不再对它们进行讨论.

3708. 变量 x 和 y 满足线性方程式

$$y = ax + b,$$

它的系数需要确定. 由于一系列的等精确测定的结果, 对于量 x 和 y 得到值 x_i, y_i ($i = 1, 2, \dots, n$).

利用最小二乘方的方法, 求系数 a 和 b 的最可靠数值.

解 根据最小二乘方的方法, 系数 a 和 b 的最可靠数

值是这样的：对于它们，误差的平方和

$$M = \sum_{i=1}^n (ax_i + b - y_i)^2$$

为最小。因此，上述问题可以通过求方程组

$$\begin{cases} \frac{\partial M}{\partial a} = 2 \sum_{i=1}^n (ax_i + b - y_i)x_i = 0, \\ \frac{\partial M}{\partial b} = 2 \sum_{i=1}^n (ax_i + b - y_i) = 0 \end{cases}$$

的解来解决。记

$$[x, y] = \sum_{i=1}^n x_i y_i, \quad [x, x] = \sum_{i=1}^n x_i^2,$$

$$[x, 1] = \sum_{i=1}^n x_i, \quad [y, 1] = \sum_{i=1}^n y_i,$$

则上述方程组化为

$$\begin{cases} a[x, x] + b[x, 1] = [x, y], \\ a[x, 1] + bn = [y, 1]. \end{cases}$$

系数行列式

$$\begin{aligned} \Delta &= \begin{vmatrix} [x, x] & [x, 1] \\ [x, 1] & n \end{vmatrix} = n \sum_{i=1}^n x_i^2 - \left(\sum_{i=1}^n x_i \right)^2 \\ &= (n-1) \sum_{i=1}^n x_i^2 - 2 \sum_{i < j} x_i x_j = \sum_{i < j} (x_i - x_j)^2. \end{aligned}$$

当 $\Delta \neq 0$ 时，方程组有唯一的一组解，且

$$a = \frac{\begin{vmatrix} [x, y] & [x, 1] \\ [y, 1] & n \end{vmatrix}}{\begin{vmatrix} [x, x] & [x, 1] \\ [x, 1] & n \end{vmatrix}} = \frac{n \sum_{i=1}^n x_i y_i - \left(\sum_{i=1}^n x_i \right) \left(\sum_{i=1}^n y_i \right)}{\sum_{i < j} (x_i - x_j)^2}$$

$$b = \frac{\begin{vmatrix} [x, x] & [x, y] \\ [x, 1] & [y, 1] \end{vmatrix}}{\begin{vmatrix} [x, x] & [x, 1] \\ [x, 1] & n \end{vmatrix}}$$

$$= \frac{\left(\sum_{i=1}^n x_i^2\right)\left(\sum_{i=1}^n y_i\right) - \left(\sum_{i=1}^n x_i y_i\right)\left(\sum_{i=1}^n x_i\right)}{\sum_{i=1}^n (x_i - \bar{x})^2}$$

显然, 此时 M 为最小. 因此, 上述 a 和 b 即为所求.

3709. 在平面上已知 n 个点 $M_i(x_i, y_i)$ ($i=1, 2, \dots, n$).

直线 $x \cos \alpha + y \sin \alpha - p = 0$ 在怎样的位置时, 已知点与此直线的偏差的平方和为最小?

解 已知点与直线的偏差平方和

$$M(\alpha, p) = \sum_{i=1}^n (x_i \cos \alpha + y_i \sin \alpha - p)^2.$$

记

$$\bar{x} = \frac{1}{n} \sum_{i=1}^n x_i, \quad \bar{y} = \frac{1}{n} \sum_{i=1}^n y_i.$$

$$\overline{xy} = \frac{1}{n} \sum_{i=1}^n x_i y_i, \quad \overline{x^2} = \frac{1}{n} \sum_{i=1}^n x_i^2, \quad \overline{y^2} = \frac{1}{n} \sum_{i=1}^n y_i^2,$$

则所求直线的参数 α 和 p 应满足方程

$$\begin{aligned} \frac{\partial M}{\partial \alpha} &= 2 \sum_{i=1}^n (x_i \cos \alpha + y_i \sin \alpha - p) (y_i \cos \alpha - x_i \sin \alpha) \\ &= 2 \sum_{i=1}^n [x_i y_i \cos 2\alpha + (y_i^2 - x_i^2) \frac{\sin 2\alpha}{2} \\ &\quad - y_i p \cos \alpha + x_i p \sin \alpha] \\ &= n [2 \overline{xy} \cos 2\alpha + (\overline{y^2} - \overline{x^2}) \sin 2\alpha - 2p (\overline{y} \cos \alpha \\ &\quad - \overline{x} \sin \alpha)] = 0, \end{aligned} \quad (1)$$

$$\begin{aligned}\frac{\partial M}{\partial p} &= -2 \sum_{i=1}^n (x_i \cos \alpha + y_i \sin \alpha - p) \\ &= -2n(\bar{x} \cos \alpha + \bar{y} \sin \alpha - p) = 0.\end{aligned}\quad (2)$$

由(2)式, 解得

$$p = \bar{x} \cos \alpha + \bar{y} \sin \alpha.\quad (3)$$

将(3)式代入(1)式, 即可解出

$$\operatorname{tg} 2\alpha = \frac{2(\bar{x} \cdot \bar{y} - \overline{xy})}{[\bar{x}^2 - (\overline{x^2})][\bar{y}^2 - (\overline{y^2})]}.\quad (4)$$

在 $(0, 2\pi)$ 范围内, (4)式的解 α 共有四个:

$$\alpha_0; \alpha_0 + \frac{\pi}{2}; \alpha_0 + \pi; \alpha_0 + \frac{3\pi}{2};$$

其中 $0 \leq \alpha_0 < \frac{\pi}{2}$. 将这四个解代入(3)式可以求出 p .

根据习惯, 取 $p \geq 0$, 故上述四个 α 只有两个满足 $p \geq 0$ 的要求^{**}). 记为 $\alpha_1, p_1; \alpha_2, p_2$. 这样就得到两条互相垂直的直线:

$$\begin{cases} x \cos \alpha_1 + y \sin \alpha_1 - p_1 = 0, & (5) \\ x \cos \alpha_2 + y \sin \alpha_2 - p_2 = 0. & (6) \end{cases}$$

显然, $M(\alpha, p)$ 一定在 p 为有限值的点上取得最小值. 因此, 只要比较 $M(\alpha_1, p_1)$ 和 $M(\alpha_2, p_2)$ 的值, M 较小的那条直线即为所求^{***}).

*) 当(4)式分母为零而分子不为零时, 解为 $2\alpha =$

$$\frac{\pi}{2}, \frac{3\pi}{2}, \frac{5\pi}{2}, \frac{7\pi}{2}.$$

当分子分母同时为零时, 有无穷

多个解, 即任意一条过 n 个点的重心的直线均使 $M(\alpha,$

p)为最小, 具体的讨论不进行了.

**) 也可能同时有一对或两对 α 使 $p=0$, 但此时代表的直线仍只有互相垂直的两条, 只是直线方程(5)或(6)有两种不同的表示法而已.

***) 特殊情况下也可能有 $M(\alpha_1, p_1) = M(\alpha_2, p_2)$, 此时使 M 取得最小值的直线有两条.

3710. 在区间(1,3)内用线性函数 $ax+b$, 来近似地代替函数 x^2 , 使得绝对偏差

$$\Delta = \sup |x^2 - (ax+b)| \quad (1 \leq x \leq 3)$$

为最小.

解 考虑函数

$$u(a,b) = \Delta^2 = \sup_{1 \leq x \leq 3} [x^2 - (ax+b)]^2,$$

$$f(x,a,b) = x^2 - (ax+b).$$

由于 $\frac{\partial f}{\partial x} = 2x - a$, 故当固定 a, b 时, $f(x, a, b)$ 只在

$x = \frac{a}{2}$ 处达到极值 $f(\frac{a}{2}, a, b)$. 当限制 $1 \leq x \leq 3$ 时,

只有当 $2 < a < 6$ 时, $f(x, a, b)$ 才可能在 $1 < x < 3$ 内部达到极值. 于是,

$$u(a,b) = \begin{cases} \max\{f^2(1,a,b), f^2(3,a,b), \\ f^2(\frac{a}{2}, a, b)\}, & 2 < a < 6; \\ \max\{f^2(1,a,b), f^2(3,a,b)\}, & a \leq 2 \text{ 或 } a \geq 6. \end{cases}$$

从上式得知, 对一切 (a, b) 均有 $u(a, b) \geq 0$.

设从上式已解出平面区域 Ω_1, Ω_2 及 Ω_3 , 使得

$$u(a, b) = \begin{cases} f^2(1, a, b) = (1 - a - b)^2, & (a, b) \in \Omega_1; \\ f^2(3, a, b) = (9 - 3a - b)^2, & (a, b) \in \Omega_2; \\ f^2\left(\frac{a}{2}, a, b\right) = \left(\frac{a^2}{4} + b\right)^2, & (a, b) \in \Omega_3, \\ 2 \leq a \leq 6. \end{cases}$$

由于 $u(a, b) \geq 0$ ，不难看出 $u(a, b)$ 在区域 Ω_i ($i=1, 2, 3$) 内部均无静止点。再看区域边界的情况。以 Ω_1 及 Ω_3 的边界为例。根据 $u(a, b)$ 的连续性，即知在边界上有 $u(a, b) = (1 - a - b)^2$ ，且满足条件

$$(1 - a - b)^2 = \left(\frac{a^2}{4} + b\right)^2.$$

下面我们求满足条件极值的必要条件的点。设

$$F(a, b) = (1 - a - b)^2 + \lambda \left[(1 - a - b)^2 - \left(\frac{a^2}{4} + b\right)^2 \right],$$

则

$$\begin{cases} \frac{\partial F}{\partial a} = -2(1 + \lambda)(1 - a - b) - \lambda a \left(\frac{a^2}{4} + b\right), \\ \frac{\partial F}{\partial b} = -2(1 + \lambda)(1 - a - b) - 2\lambda \left(\frac{a^2}{4} + b\right). \end{cases}$$

使 $\frac{\partial F}{\partial a} = 0$ ， $\frac{\partial F}{\partial b} = 0$ 且满足条件 $1 - a - b \neq 0$ ， $\frac{a^2}{4} + b \neq 0$ 的点没有。

同法可证。

在 Ω_1, Ω_2 及 Ω_2, Ω_3 的边界上也无静止点。但是， $u(a, b)$ 一定在区域内达到最小值。因此，只能在 $\Omega_1, \Omega_2, \Omega_3$ 的边界交点上取得最小值，即在满足方程

$$(1 - a - b)^2 = (9 - 3a - b)^2 = \left(\frac{a^2}{4} + b\right)^2 \quad (1)$$

的点 (a, b) 上取得最小值, 方程(1)可转化为下面四组方程

$$\begin{cases} 1-a-b=9-3a-b=-\left(\frac{a^2}{4}+b\right), & (2) \end{cases}$$

$$\begin{cases} 1-a-b=9-3a-b=\frac{a^2}{4}+b, & (3) \end{cases}$$

$$\begin{cases} 1-a-b=-(9-3a-b)=-\left(\frac{a^2}{4}+b\right), & (4) \end{cases}$$

$$\begin{cases} 1-a-b=-(9-3a-b)=\frac{a^2}{4}+b. & (5) \end{cases}$$

方程组(2)无解.

方程组(3)的解为 $a=4, b=-\frac{7}{2}$. 对应的 $\Delta=\frac{1}{2}$.

方程组(4)的解为 $a=2, b=1$. 对应的 $\Delta=2$.

方程组(5)的解为 $a=6, b=-7$. 对应的 $\Delta=2$.

综上所述, 可知: 在区间 $(1, 3)$ 内, 用线性函数 $4x - \frac{7}{2}$ 来近似地代替函数 x^2 , 即可使绝对偏差 Δ 为最小, 且 $\Delta_{\min}=\frac{1}{2}$.

第七章 带参数的积分

§ 1. 带参数的常义积分

1° 积分的连续性 若函数 $f(x, y)$ 于有界的域 $R (a \leq x \leq A, b \leq y \leq B)$ 内有定义并且是连续的, 则

$$F(y) = \int_a^A f(x, y) dx$$

是在闭区间 $b \leq y \leq B$ 上的连续函数.

2° 积分符号下的微分法 若除在 1° 中所已指明的条件之外, 并且偏导函数 $f'_y(x, y)$ 在区域 R 内连续, 则当 $b < y < B$ 时 莱布尼兹公式

$$\frac{d}{dy} \int_a^A f(x, y) dx = \int_a^A f'_y(x, y) dx$$

为真.

在更普遍的情况下, 当积分的限为参数 y 的可微分函数 $\varphi(y)$ 和 $\psi(y)$ 并且当 $b < y < B$ 时 $a \leq \varphi(y) \leq A, a \leq \psi(y) \leq A$, 有:

$$\begin{aligned} & \frac{d}{dy} \int_{\varphi(y)}^{\psi(y)} f(x, y) dx \\ &= f[\psi(y), y] \psi'(y) - f[\varphi(y), y] \varphi'(y) \\ &+ \int_{\varphi(y)}^{\psi(y)} f'_y(x, y) dx \quad (b < y < B). \end{aligned}$$

3° 积分符号下的积分法 在 1° 的条件下有

$$\int_a^B dy \int_a^A f(x, y) dx = \int_a^A dx \int_a^B f(x, y) dy.$$

3711. 证明: 不连续函数 $f(x, y) = \text{sgn}(x - y)$ 的积分

$$F(y) = \int_0^1 f(x, y) dx$$

为连续函数. 作出函数 $u = F(y)$ 的图形.

证 当 $-\infty < y < 0$ 时,

$$F(y) = \int_0^1 1 \cdot dx = 1;$$

当 $0 \leq y \leq 1$ 时,

$$F(y) = \int_0^y (-1) dx + \int_y^1 1 \cdot dx = 1 - 2y;$$

当 $1 < y < +\infty$ 时,

$$F(y) = \int_0^1 (-1) dx = -1.$$

由于

$$\lim_{y \rightarrow +0} F(y) = \lim_{y \rightarrow +0} (1 - 2y) = 1, \quad \lim_{y \rightarrow -0} F(y) = 1$$

且 $F(0) = 1$, 即有



图 7.1

$$F(+0) = F(-0) = F(0),$$

故 $u = F(y)$ 当 $y = 0$ 时为连续的。

同法可证 $u = F(y)$ 当 $y = 1$ 时为连续的。当 $y \neq 0, y \neq 1$ 时, $u = F(y)$ 显然连续。于是, $u = F(y)$ 在整个 Oy 轴上均为连续的。如图 7·1 所示。

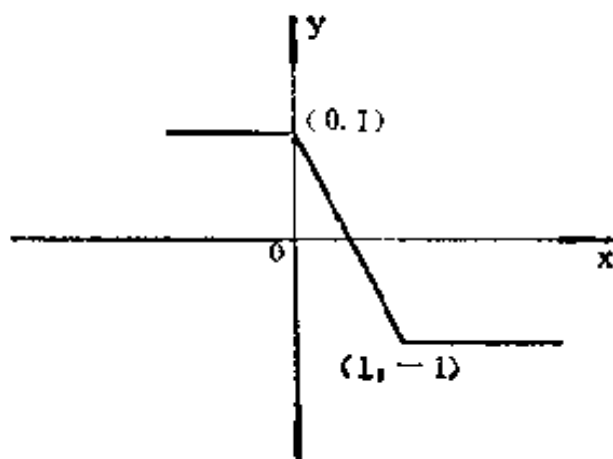
3712. 研究函数

$$F(y) = \int_0^1 \frac{y f(x)}{x^2 + y^2} dx$$

的连续性, 其中 $f(x)$ 在闭区间 $[0, 1]$ 上是正的连续函数。

解 当 $y \neq 0$ 时, 被积函数是连续的。因此, $F(y)$ 为连续函数。

当 $y = 0$ 时, 显然有 $F(0) = 0$ 。

当 $y > 0$ 时, 设 m 为 $f(x)$ 在 $[0, 1]$ 上的最小值, 则 $m > 0$ 。由于

$$F(y) \geq m \int_0^1 \frac{y}{x^2 + y^2} dx = m \operatorname{arc} \operatorname{tg} \frac{1}{y}$$

及

$$\lim_{y \rightarrow +0} \operatorname{arc} \operatorname{tg} \frac{1}{y} = \frac{\pi}{2},$$

故有

$$\lim_{y \rightarrow +0} F(y) \geq \frac{m\pi}{2} > 0.$$

于是, $F(y)$ 当 $y = 0$ 时不连续。

3713. 求:

$$(a) \lim_{\alpha \rightarrow 0} \int_{\alpha}^{1+\alpha} \frac{dx}{1+x^2+\alpha^2};$$

$$(b) \lim_{\alpha \rightarrow 0} \int_{-1}^1 \sqrt{x^2+\alpha^2} dx;$$

$$(B) \lim_{\alpha \rightarrow 0} \int_0^2 x^2 \cos \alpha x dx;$$

$$(r) \lim_{n \rightarrow \infty} \int_0^1 \frac{dx}{1+\left(1+\frac{x}{n}\right)^n}.$$

解 (a) 因 $\frac{1}{1+x^2+\alpha^2}$, α , $1+\alpha$ 都是连续函数,

故含参变量 α 的积分 $F(\alpha) = \int_{\alpha}^{1+\alpha} \frac{dx}{1+x^2+\alpha^2}$ 是 α 在 $-\infty < \alpha < +\infty$ 上的连续函数, 因此

$$\begin{aligned} & \lim_{\alpha \rightarrow 0} \int_{\alpha}^{1+\alpha} \frac{dx}{1+x^2+\alpha^2} \\ &= \lim_{\alpha \rightarrow 0} F(\alpha) = F(0) = \int_0^1 \frac{dx}{1+x^2} \\ &= \arctg x \Big|_0^1 = \frac{\pi}{4}. \end{aligned}$$

(b) 同样, $F(\alpha) = \int_{-1}^1 \sqrt{x^2+\alpha^2} dx$ 是 $-\infty < \alpha < +\infty$ 上的连续函数, 因此

$$\begin{aligned} & \lim_{\alpha \rightarrow 0} \int_{-1}^1 \sqrt{x^2+\alpha^2} dx \\ &= \lim_{\alpha \rightarrow 0} F(\alpha) = F(0) = \int_{-1}^1 \sqrt{x^2} dx \end{aligned}$$

$$= 2 \int_0^1 x dx = 1.$$

(B) 同样, $F(a) = \int_0^2 x^2 \cos ax dx$ 是 $-\infty < a < +\infty$ 上的连续函数, 故

$$\begin{aligned} & \lim_{a \rightarrow 0} \int_0^2 x^2 \cos ax dx \\ &= \lim_{a \rightarrow 0} F(a) = F(0) = \int_0^2 x^2 dx = \frac{8}{3}. \end{aligned}$$

(C) 考虑二元函数

$$f(x, y) = \begin{cases} \frac{1}{1 + (1 + xy)^{\frac{1}{y}}}, & \text{当 } 0 \leq x \leq 1, \\ & 0 < y \leq 1 \text{ 时;} \\ \frac{1}{1 + e^x}, & \text{当 } 0 \leq x \leq 1, y = 0 \text{ 时.} \end{cases}$$

由 $\lim_{u \rightarrow +0} (1+u)^{\frac{1}{u}} = e$ 易知 $f(x, y)$ 是 $0 \leq x \leq 1, 0 \leq y$

≤ 1 上的连续函数. 从而积分 $F(y) = \int_0^1 f(x, y) dx$ 是 $0 \leq y \leq 1$ 上的连续函数, 因此

$$\lim_{y \rightarrow +0} F(y) = F(0),$$

从而更有

$$\lim_{n \rightarrow \infty} \int_0^1 \frac{dx}{1 + \left(1 + \frac{x}{n}\right)^n}$$

$$\begin{aligned}
&= \lim_{n \rightarrow \infty} F\left(\frac{1}{n}\right) = F(0) = \int_0^1 f(x, 0) dx \\
&= \int_0^1 \frac{dx}{1+e^x} = \ln \frac{e^x}{1+e^x} \Big|_0^1 = \ln \frac{2e}{1+e}.
\end{aligned}$$

3714. 设函数 $f(x)$ 在闭区间 $[a, A]$ 上连续. 证明

$$\lim_{h \rightarrow +0} \frac{1}{h} \int_a^x [f(t+h) - f(t)] dt = f(x) - f(a)$$

($a < x < A$).

证 由于 $f(x)$ 在 (a, A) 上连续, 故在 (a, A) 上存在原函数. 于是,

$$\begin{aligned}
&\lim_{h \rightarrow +0} \frac{1}{h} \int_a^x [f(t+h) - f(t)] dt \\
&= \lim_{h \rightarrow +0} \frac{1}{h} [F(x+h) - F(a+h) - F(x) + F(a)] \\
&= \lim_{h \rightarrow +0} \frac{F(x+h) - F(x)}{h} - \lim_{h \rightarrow +0} \frac{F(a+h) - F(a)}{h} \\
&= F'(x) - F'(a) = f(x) - f(a).
\end{aligned}$$

3715. 在下式中可否于积分符号下完成极限运算

$$\lim_{y \rightarrow 0} \int_0^1 \frac{x}{y^2} e^{-\frac{x^2}{y^2}} dx ?$$

解 不能. 事实上,

$$\begin{aligned}
&\lim_{y \rightarrow 0} \int_0^1 \frac{x}{y^2} e^{-\frac{x^2}{y^2}} dx = \lim_{y \rightarrow 0} \left(-\frac{1}{2} e^{-\frac{x^2}{y^2}} \Big|_0^1 \right) \\
&= \lim_{y \rightarrow 0} \left(\frac{1}{2} - \frac{1}{2} e^{-\frac{1}{y^2}} \right) = \frac{1}{2},
\end{aligned}$$

而

$$\int_0^1 \left(\lim_{y \rightarrow 0} \frac{x}{y^2} e^{-\frac{x^2}{y^2}} \right) dx = \int_0^1 0 \cdot dx = 0.$$

3716. 当 $y = 0$ 时, 可否根据莱布尼兹法则计算函数

$$F(y) = \int_0^1 \ln \sqrt{x^2 + y^2} dx$$

的导数?

解 不能. 事实上, 我们有: 当 $y \neq 0$ 时,

$$\begin{aligned} F(y) &= \int_0^1 \ln \sqrt{x^2 + y^2} dx \\ &= x \ln \sqrt{x^2 + y^2} \Big|_{x=0}^{x=1} \\ &\quad - \int_0^1 \frac{x^2}{x^2 + y^2} dx \\ &= \ln \sqrt{1 + y^2} - \int_0^1 \left(1 - \frac{y^2}{x^2 + y^2} \right) dx \\ &= \ln \sqrt{1 + y^2} - 1 + y \operatorname{arc} \operatorname{tg} \frac{1}{y}. \end{aligned}$$

又有

$$F(0) = \int_0^1 \ln x dx = x \ln x \Big|_0^1 - \int_0^1 dx = -1.$$

由此可知

$$F'_+(0) = \lim_{y \rightarrow +0} \frac{F(y) - F(0)}{y}$$

$$\begin{aligned}
&= \lim_{y \rightarrow +0} \left[\frac{\ln(1+y^2)}{2y} + \operatorname{arctg} \frac{1}{y} \right] \\
&= \frac{\pi}{2},
\end{aligned}$$

$$\begin{aligned}
F'_-(0) &= \lim_{y \rightarrow -0} \frac{F(y) - F(0)}{y} \\
&= \lim_{y \rightarrow -0} \left[\frac{\ln(1+y^2)}{2y} + \operatorname{arctg} \frac{1}{y} \right] \\
&= -\frac{\pi}{2},
\end{aligned}$$

故 $F'(0)$ 不存在.

另一方面, 当 $x > 0$ 时,

$$\begin{aligned}
&\left(\frac{\partial}{\partial y} \ln \sqrt{x^2 + y^2} \right) \Big|_{y=0} \\
&= \frac{y}{x^2 + y^2} \Big|_{y=0} = 0,
\end{aligned}$$

故

$$\int_0^1 \left(\frac{\partial}{\partial y} \ln \sqrt{x^2 + y^2} \right) \Big|_{y=0} dx = 0.$$

由此可知, 当 $y = 0$ 时不能在积分号下求导数, 就是求右导数或求左导数也不行, 因为

$$\begin{aligned}
F'_+(0) &= \frac{\pi}{2} \neq 0 \\
&= \int_0^1 \left(\frac{\partial}{\partial y} \ln \sqrt{x^2 + y^2} \right) \Big|_{y=0} dx,
\end{aligned}$$

$$\begin{aligned}
 F'_-(0) &= -\frac{\pi}{2} \neq 0 \\
 &= \int_0^1 \left(\frac{\partial}{\partial y} \ln \sqrt{x^2 + y^2} \right) \Big|_{y=0} dx.
 \end{aligned}$$

3717. 若

$$F(x) = \int_x^{x^2} e^{-xy^2} dy,$$

计算 $F'(x)$.

$$\begin{aligned}
 \text{解 } F'(x) &= \frac{d}{dx} (x^2) \cdot e^{-xy^2} \Big|_{y=x^2} \\
 &\quad - \frac{dx}{dx} \cdot e^{-xy^2} \Big|_{y=x} \\
 &\quad + \int_x^{x^2} \frac{\partial}{\partial x} (e^{-xy^2}) dy \\
 &= 2xe^{-x^5} - e^{-x^3} - \int_x^{x^2} y^2 e^{-xy^2} dy.
 \end{aligned}$$

3718. 设:

$$(a) F(a) = \int_{\sin a}^{\cos a} e^{a\sqrt{1-x^2}} dx;$$

$$(b) F(a) = \int_{a+a}^{b+a} \frac{\sin ax}{x} dx;$$

$$(c) F(a) = \int_0^a \frac{\ln(1+ax)}{x} dx;$$

$$(d) F(a) = \int_0^a f(x+a, x-a) dx;$$

$$(A) F(a) = \int_0^{a^2} dx \int_{x-a}^{x+a} \sin(x^2 + y^2 - a^2) dy,$$

求 $F'(a)$.

$$\text{解 (a) } F'(a) = -\sin a \cdot e^{a \cdot \sin a} - \cos a \cdot e^{a |\cos a|}$$

$$+ \int_{\sin a}^{\cos a} \sqrt{1-x^2} e^{a\sqrt{1-x^2}} dx.$$

$$(b) F'(a) = \frac{\sin a(b+a)}{b+a} - \frac{\sin a(a+a)}{a+a}$$

$$+ \int_{a+a}^{b+a} \cos ax dx$$

$$= \left(\frac{1}{a} + \frac{1}{b+a} \right) \sin a(b+a)$$

$$- \left(\frac{1}{a} + \frac{1}{a+a} \right) \sin a(a+a).$$

$$(B) F'(a) = \frac{1}{a} \ln(1+a^2) + \int_0^a \frac{1}{1+ax} dx$$

$$= \frac{2}{a} \ln(1+a^2).$$

(r) 设 $u=x+a$, $v=x-a$, 则

$$F(a) = \int_0^a f(u,v) dx.$$

于是,

$$F'(a) = f(2a, 0) + \int_0^a [f'_u(u,v) - f'_v(u,v)] dx$$

$$= f(2a, 0) + 2 \int_0^a f'_u(u,v) dx$$

$$\begin{aligned}
& - \int_0^a [f'_u(u, v) + f'_v(u, v)] dx \\
& = f(2a, 0) + 2 \int_0^a f'_u(u, v) dx \\
& \quad - \int_0^a \frac{d}{dx} f(u, v) dx \\
& = f(2a, 0) + 2 \int_0^a f'_u(u, v) dx \\
& \quad - f(x+a, x-a) \Big|_{x=0}^{x=a} \\
& = f(2a, 0) + 2 \int_0^a f'_u(u, v) dx \\
& \quad - [f(2a, 0) - f(a, -a)] \\
& = f(a, -a) + 2 \int_0^a f'_u(u, v) dx.
\end{aligned}$$

$$\begin{aligned}
(\text{B}) \quad F'(\alpha) & = 2\alpha \int_{\alpha^2 - \alpha}^{\alpha^2 + \alpha} \sin(\alpha^4 + y^2 - \alpha^2) dy \\
& + \int_0^{\alpha^2} \left[\frac{\partial}{\partial \alpha} \int_{x-\alpha}^{x+\alpha} \sin(x^2 + y^2 - \alpha^2) dy \right] dx \\
& = 2\alpha \int_{\alpha^2 - \alpha}^{\alpha^2 + \alpha} \sin(\alpha^4 + y^2 - \alpha^2) dy \\
& + \int_0^{\alpha^2} \left\{ \sin[x^2 + (x+\alpha)^2 - \alpha^2] \right. \\
& \quad \left. - \sin[x^2 + (x-\alpha)^2 - \alpha^2] \right\} \cdot (-1)
\end{aligned}$$

$$\begin{aligned}
& + \int_{x-a}^{x+a} (-2\alpha) \cos(x^2 + y^2 - \alpha^2) dy \} dx \\
& = 2\alpha \int_{a^2-a}^{a^2+a} \sin(\alpha^4 + y^2 - \alpha^2) dy \\
& + \int_0^{a^2} \{ \sin(2x^2 + 2\alpha x) + \sin(2x^2 - 2\alpha x) \\
& + \int_{x-a}^{x+a} (-2\alpha) \cos(x^2 + y^2 - \alpha^2) dy \} dx \\
& = 2\alpha \int_{a^2-a}^{a^2+a} \sin(\alpha^4 + y^2 - \alpha^2) dy \\
& + 2 \int_0^{a^2} \sin 2x^2 \cos 2\alpha x dx \\
& - 2\alpha \int_0^{a^2} dx \int_{x-a}^{x+a} \cos(x^2 + y^2 - \alpha^2) dy.
\end{aligned}$$

3719. 若

$$F(x) = \int_0^x (x+y)f(y)dy,$$

其中 $f(x)$ 为可微分的函数, 求 $F''(x)$.

$$\text{解 } F'(x) = 2xf(x) + \int_0^x f(y)dy,$$

$$\begin{aligned}
F''(x) &= 2f(x) + 2xf'(x) + f(x) \\
&= 3f(x) + 2xf'(x).
\end{aligned}$$

3720. 设:

$$F(x) = \int_a^b f(y)|x-y|dy,$$

其中 $a < b$ 及 $f(y)$ 为可微分的函数, 求 $F''(x)$.

解 当 $x \in (a, b)$ 时, 由于

$$F(x) = \int_a^x (x-y)f(y)dy + \int_x^b (y-x)f(y)dy,$$

故有

$$\begin{aligned} F'(x) &= \frac{d}{dx} \int_a^x (x-y)f(y)dy \\ &\quad - \frac{d}{dx} \int_x^b (y-x)f(y)dy \\ &= \int_a^x \frac{\partial}{\partial x} [(x-y)f(y)]dy \\ &\quad - \int_x^b \frac{\partial}{\partial x} [(y-x)f(y)]dy \\ &= \int_a^x f(y)dy + \int_x^b f(y)dy, \end{aligned}$$

$$F''(x) = f(x) + f(x) = 2f(x).$$

当 $x \in (a, b)$ 时, 例如 $x \leq a$, 则

$$F(x) = \int_a^b (y-x)f(y)dy,$$

故有

$$\begin{aligned} F'(x) &= \int_a^b \frac{\partial}{\partial x} [(y-x)f(y)]dy \\ &= - \int_a^b f(y)dy, \end{aligned}$$

$$F''(x) = 0;$$

同理, 对于 $x \geq b$ 也可得 $F''(x) = 0$. 总之,

$$F''(x) = \begin{cases} 2f(x), & \text{当 } x \in (a, b); \\ 0, & \text{当 } x \notin (a, b). \end{cases}$$

3721. 设:

$$F(x) = \frac{1}{h^2} \int_0^h d\xi \int_0^h f(x+\xi+\eta) d\eta \quad (h > 0),$$

其中 $f(x)$ 为连续函数, 求 $F''(x)$.

$$\begin{aligned} \text{解 } F(x) &= \frac{1}{h^2} \int_0^h d\xi \int_0^h f(x+\xi+\eta) d\eta \\ &= \frac{1}{h^2} \int_0^h d\xi \int_{x+\xi}^{x+\xi+h} f(u) du. \end{aligned}$$

于是,

$$\begin{aligned} F'(x) &= \frac{1}{h^2} \int_0^h \left[\frac{\partial}{\partial x} \int_{x+\xi}^{x+\xi+h} f(u) du \right] d\xi \\ &= \frac{1}{h^2} \int_0^h [f(x+\xi+h) - f(x+\xi)] d\xi \\ &= \frac{1}{h^2} \left[\int_{x+h}^{x+2h} f(u) du - \int_x^{x+h} f(u) du \right], \\ F''(x) &= \frac{1}{h^2} [f(x+2h) - f(x+h) - f(x+h) \\ &\quad + f(x)] \\ &= \frac{1}{h^2} [f(x+2h) - 2f(x+h) + f(x)]. \end{aligned}$$

3722. 设:

$$F(x) = \int_0^x f(t)(x-t)^{n-1} dt,$$

求 $F^{(n)}(x)$.

$$\begin{aligned}\text{解 } F'(x) &= \int_0^x \frac{\partial}{\partial x} [f(t)(x-t)^{n-1}] dt \\ &= (n-1) \int_0^x f(t)(x-t)^{n-2} dt,\end{aligned}$$

$$F''(x) = (n-1)(n-2) \int_0^x f(t)(x-t)^{n-3} dt,$$

.....

$$F^{(n-1)}(x) = (n-1)! \int_0^x f(t) dt,$$

最后得

$$F^{(n)}(x) = (n-1)! f(x).$$

3723. 在区间 $1 \leq x \leq 3$ 上用线性函数 $a+bx$ 近似地代替函数 $f(x)=x^2$, 使得

$$\int_1^3 (a+bx-x^2)^2 dx = \min.$$

解 设 $F(a, b) = \int_1^3 (a+bx-x^2)^2 dx$, 则由于 $F(a, b)$ 是 a 和 b 的二元连续函数, 并且易知当 $r = \sqrt{a^2+b^2} \rightarrow +\infty$ 时, $F(a, b) \rightarrow +\infty$, 故 $F(a, b)$ 必在有限处取得最小值. 解方程组

$$\begin{cases} \frac{\partial F}{\partial a} = 2 \int_1^3 (a+bx-x^2) dx = 4a + 8b - \frac{52}{3} = 0, \\ \frac{\partial F}{\partial b} = 2 \int_1^3 x(a+bx-x^2) dx = 8a + \frac{52}{3}b - 40 = 0 \end{cases}$$

得唯一的一组解 $a = -\frac{11}{3}$, $b = 4$.

于是, 当 $a = -\frac{11}{3}$, $b = 4$ 时 $F(a, b)$ 达最小

值, 即所求的线性函数为 $4x - \frac{11}{3}$.

3724. 依条件: 函数 $a+bx$ 及 $\sqrt{1+x^2}$ 在已知区间 $[0, 1]$ 上的平均平方差为最小, 求近似公式

$$\sqrt{1+x^2} \approx a+bx \quad (0 \leq x \leq 1).$$

解 按题设, 即在区间 $0 \leq x \leq 1$ 上用线性函数 $a+bx$ 近似代替函数 $f(x) = \sqrt{1+x^2}$, 使得

$$\int_0^1 (a+bx - \sqrt{1+x^2})^2 dx = \min.$$

设 $F(a, b) = \int_0^1 (a+bx - \sqrt{1+x^2})^2 dx$, 则 $F(a, b)$

是 a 和 b 的二元连续函数, 并且易知当 $r = \sqrt{a^2+b^2} \rightarrow +\infty$ 时, $F(a, b) \rightarrow +\infty$, 故 $F(a, b)$ 必在有限处取得最小值. 解方程组

$$\begin{cases} \frac{\partial F}{\partial a} = 2 \int_0^1 (a+bx - \sqrt{1+x^2}) dx \\ \quad = 2a + b - [\sqrt{2} + \ln(1+\sqrt{2})] = 0, \\ \frac{\partial F}{\partial b} = 2 \int_0^1 x(a+bx - \sqrt{1+x^2}) dx \\ \quad = a + \frac{2}{3}b - \frac{2}{3}(2\sqrt{2} - 1) = 0 \end{cases}$$

得唯一的一组解 $a \approx 0.934$, $b \approx 0.427$.

于是, 当 $a \approx 0.934$, $b \approx 0.427$ 时, $F(a, b)$ 为最小值, 即所求的近似公式为

$$\sqrt{1+x^2} \approx 0.934 + 0.427x \quad (0 \leq x \leq 1).$$

3725. 求完全椭圆积分

$$E(k) = \int_0^{\frac{\pi}{2}} \sqrt{1-k^2 \sin^2 \varphi} d\varphi$$

及

$$F(k) = \int_0^{\frac{\pi}{2}} \frac{d\varphi}{\sqrt{1-k^2 \sin^2 \varphi}} \quad (0 < k < 1)$$

的导函数并以函数 $E(k)$ 和 $F(k)$ 来表示它们.

证明 $E(k)$ 满足微分方程式

$$E''(k) + \frac{1}{k} E'(k) + \frac{E(k)}{1-k^2} = 0.$$

解
$$\begin{aligned} E'(k) &= - \int_0^{\frac{\pi}{2}} \frac{k \sin^2 \varphi}{\sqrt{1-k^2 \sin^2 \varphi}} d\varphi \\ &= \frac{1}{k} \int_0^{\frac{\pi}{2}} \frac{(1-k^2 \sin^2 \varphi) - 1}{\sqrt{1-k^2 \sin^2 \varphi}} d\varphi \\ &= \frac{1}{k} \left[\int_0^{\frac{\pi}{2}} \sqrt{1-k^2 \sin^2 \varphi} d\varphi \right. \\ &\quad \left. - \int_0^{\frac{\pi}{2}} \frac{d\varphi}{\sqrt{1-k^2 \sin^2 \varphi}} \right] \\ &= \frac{E(k) - F(k)}{k}. \end{aligned} \quad (1)$$

$$\begin{aligned}
F'(k) &= \int_0^{\frac{\pi}{2}} \frac{k \sin^2 \varphi}{(1-k^2 \sin^2 \varphi)^{\frac{3}{2}}} d\varphi \\
&= -\frac{1}{k} \int_0^{\frac{\pi}{2}} \frac{(1-k^2 \sin^2 \varphi) - 1}{(1-k^2 \sin^2 \varphi)^{\frac{3}{2}}} d\varphi \\
&= -\frac{1}{k} \int_0^{\frac{\pi}{2}} \frac{d\varphi}{\sqrt{1-k^2 \sin^2 \varphi}} \\
&\quad + \frac{1}{k} \int_0^{\frac{\pi}{2}} \frac{d\varphi}{(1-k^2 \sin^2 \varphi)^{\frac{3}{2}}}.
\end{aligned}$$

我们易证

$$\begin{aligned}
(1-k^2 \sin^2 \varphi)^{-\frac{3}{2}} &= \frac{1}{1-k^2} (1-k^2 \sin^2 \varphi)^{\frac{1}{2}} \\
&\quad - \frac{k^2}{1-k^2} \frac{d}{d\varphi} [\sin \varphi \cos \varphi (1-k^2 \sin^2 \varphi)^{-\frac{1}{2}}],
\end{aligned}$$

故有

$$\begin{aligned}
&\int_0^{\frac{\pi}{2}} (1-k^2 \sin^2 \varphi)^{-\frac{3}{2}} d\varphi \\
&= \frac{1}{1-k^2} \int_0^{\frac{\pi}{2}} (1-k^2 \sin^2 \varphi)^{\frac{1}{2}} d\varphi.
\end{aligned}$$

于是,

$$F'(k) = -\frac{F(k)}{k} + \frac{E(k)}{k(1-k^2)}. \quad (2)$$

由 (1) 式, 对 k 再求导数, 并注意到 (2) 式, 即

得

$$\begin{aligned} E''(k) &= \frac{[E'(k) - F'(k)]k - [E(k) - F(k)]}{k^2} \\ &= \frac{\left[\frac{E(k) - F(k)}{k} + \frac{F(k)}{k} - \frac{E(k)}{k(1-k^2)} \right]k - kE'(k)}{k^2} \\ &= -\frac{E(k)}{1-k^2} - \frac{E'(k)}{k}, \end{aligned}$$

即

$$E''(k) + \frac{F'(k)}{k} + \frac{E(k)}{1-k^2} = 0.$$

3726. 证明：足指数 n 为整数的贝塞尔函数

$$J_n(x) = \frac{1}{\pi} \int_0^\pi \cos(n\varphi - x \sin \varphi) d\varphi$$

满足贝塞尔方程式

$$x^2 J_n''(x) + x J_n'(x) + (x^2 - n^2) J_n(x) = 0.$$

证 $J_n'(x) = \frac{1}{\pi} \int_0^\pi \sin \varphi \cdot \sin(n\varphi - x \sin \varphi) d\varphi,$

$$J_n''(x) = -\frac{1}{\pi} \int_0^\pi \sin^2 \varphi \cdot \cos(n\varphi - x \sin \varphi) d\varphi.$$

于是,

$$\begin{aligned} &x^2 J_n''(x) + x J_n'(x) + (x^2 - n^2) J_n(x) \\ &= -\frac{1}{\pi} \int_0^\pi [(x^2 \sin^2 \varphi + n^2 - x^2) \cos(n\varphi - x \sin \varphi) \\ &\quad - x \sin \varphi \cdot \sin(n\varphi - x \sin \varphi)] d\varphi \end{aligned}$$

$$\begin{aligned}
&= -\frac{1}{\pi} \int_0^{\pi} [(n^2 - x^2 \cos^2 \varphi) \cos(n\varphi - x \sin \varphi) \\
&\quad - x \sin \varphi \cdot \sin(n\varphi - x \sin \varphi)] d\varphi \\
&= -\frac{1}{\pi} (n + x \cos \varphi) \cdot \sin(n\varphi - x \sin \varphi) \Big|_0^{\pi} = 0,
\end{aligned}$$

本题获证。

3727. 设:

$$I(a) = \int_0^a \frac{\varphi(x) dx}{\sqrt{a-x}},$$

其中函数 $\varphi(x)$ 及其导函数 $\varphi'(x)$ 在闭区间 $0 \leq x \leq a$ 上连续。

证明: 当 $0 < a < a$ 时有

$$I'(a) = \frac{\varphi(0)}{\sqrt{a}} + \int_0^a \frac{\varphi'(x)}{\sqrt{a-x}} dx.$$

证 当 $x=a$ 时, 一般说来被积函数变成无穷, 所以我们不能直接在积分号下求导数. 设 $x=at$, 则此积分变成以下形式

$$I(a) = \sqrt{a} \int_0^1 \frac{\varphi(at)}{\sqrt{1-t}} dt.$$

由于 $\frac{1}{\sqrt{1-t}}$ 在 $[0, 1]$ 上绝对可积, 故可利用积分号下求导数的公式. 于是,

$$I'(a) = \frac{1}{2\sqrt{a}} \int_0^1 \frac{\varphi(at)}{\sqrt{1-t}} dt$$

$$+ \sqrt{a} \int_0^1 \frac{t \varphi'(at)}{\sqrt{1-t}} dt.$$

再将 $x=at$ 代入上式, 得

$$\begin{aligned} I'(a) &= \frac{1}{2a} \int_0^a \frac{\varphi(x)}{\sqrt{a-x}} dx \\ &\quad + \frac{1}{a} \int_0^a \frac{x \varphi'(x)}{\sqrt{a-x}} dx. \end{aligned} \quad (1)$$

利用分部积分法可得

$$\begin{aligned} &\frac{1}{a} \int_0^a \frac{\varphi(x)}{\sqrt{a-x}} dx \\ &= \frac{2}{\sqrt{a}} \varphi(0) + \frac{2}{a} \int_0^a \sqrt{a-x} \varphi'(x) dx. \end{aligned} \quad (2)$$

另一方面, 又有

$$\begin{aligned} &\int_0^a \frac{x \varphi'(x)}{\sqrt{a-x}} dx \\ &= - \int_0^a \sqrt{a-x} \varphi'(x) dx \\ &\quad + a \int_0^a \frac{\varphi'(x)}{\sqrt{a-x}} dx. \end{aligned} \quad (3)$$

将 (2) 式及 (3) 式代入 (1) 式, 最后得

$$I'(a) = \frac{\varphi(0)}{\sqrt{a}} + \int_0^a \frac{\varphi'(x)}{\sqrt{a-x}} dx.$$

3728. 设有函数

$$u(x) = \int_0^1 K(x, y) v(y) dy,$$

其中

$$K(x, y) = \begin{cases} x(1-y), & \text{若 } x \leq y, \\ y(1-x), & \text{若 } x > y, \end{cases}$$

及 $v(y)$ 都是连续的. 证明已知函数满足方程式

$$u''(x) = -v(x) \quad (0 \leq x \leq 1).$$

证 由题设得

$$u(x) = \int_0^x y(1-x)v(y)dy \\ + \int_x^1 x(1-y)v(y)dy.$$

于是, 求导数即得

$$u'(x) = x(1-x)v(x) - \int_0^x yv(y)dy \\ - x(1-x)v(x) + \int_x^1 (1-y)v(y)dy \\ = - \int_0^x yv(y)dy + \int_x^1 (1-y)v(y)dy,$$

$$u''(x) = -xv(x) - (1-x)v(x) = -v(x),$$

所以, 函数 $u(x)$ 满足方程

$$u''(x) = -v(x) \quad (0 \leq x \leq 1).$$

3729. 设:

$$F(x, y) = \int_y^{xy} (x-yz)f(z)dz,$$

其中 $f(z)$ 为可微分的函数, 求 $F''_{xy}(x, y)$.

解 $F'_x(x, y) = y(x - xy^2)f(xy) + \int_{\frac{x}{y}}^{xy} f(z)dz,$

$$\begin{aligned} F''_{xy}(x, y) &= (x - xy^2)f(xy) \\ &\quad + y \cdot (-2xy)f(xy) \\ &\quad + y(x - xy^2)f'(xy) \cdot x \\ &\quad + xf(xy) + \frac{x}{y^2}f\left(\frac{x}{y}\right) \\ &= x(2 - 3y^2)f(xy) \\ &\quad + x^2y(1 - y^2)f'(xy) \\ &\quad + \frac{x}{y^2}f\left(\frac{x}{y}\right). \end{aligned}$$

3730. 设 $f(x)$ 为可微分两次的函数及 $F(x)$ 为可微分的函数. 证明: 函数

$$\begin{aligned} u(x, t) &= \frac{1}{2}[f(x - at) + f(x + at)] \\ &\quad + \frac{1}{2a} \int_{x-at}^{x+at} F(z)dz \end{aligned}$$

满足弦振动的方程式

$$\frac{\partial^2 u}{\partial t^2} = a^2 \frac{\partial^2 u}{\partial x^2}$$

及初值条件: $u(x, 0) = f(x), u'_t(x, 0) = F(x).$

证 $\frac{\partial u}{\partial t} = \frac{1}{2}[-af'(x - at) + af'(x + at)]$

$$+ \frac{1}{2}F(x + at) + \frac{1}{2}F(x - at),$$

$$\begin{aligned}\frac{\partial^2 u}{\partial t^2} &= \frac{1}{2} [a^2 f''(x-at) + a^2 f''(x+at)] \\ &\quad + \frac{a}{2} F'(x+at) - \frac{a}{2} F'(x-at). \quad (1)\end{aligned}$$

$$\begin{aligned}\frac{\partial u}{\partial x} &= \frac{1}{2} [f'(x-at) + f'(x+at)] \\ &\quad + \frac{1}{2a} F(x+at) - \frac{1}{2a} F(x-at),\end{aligned}$$

$$\begin{aligned}\frac{\partial^2 u}{\partial x^2} &= \frac{1}{2} [f''(x-at) + f''(x+at)] \\ &\quad + \frac{1}{2a} F'(x+at) - \frac{1}{2a} F'(x-at). \quad (2)\end{aligned}$$

比较 (1) 式及 (2) 式, 即得

$$\frac{\partial^2 u}{\partial t^2} = a^2 \frac{\partial^2 u}{\partial x^2}.$$

此外, 还有

$$\begin{aligned}u(x, 0) &= \frac{1}{2} [f(x-0 \cdot t) + f(x+0 \cdot t)] \\ &\quad + \frac{1}{2a} \int_{x-0 \cdot t}^{x+0 \cdot t} F(z) dz = f(x),\end{aligned}$$

$$\begin{aligned}u'_x(x, 0) &= \frac{1}{2} [-a f'(x) + a f'(x)] \\ &\quad + \frac{1}{2} F(x) + \frac{1}{2} F(x) = F(x).\end{aligned}$$

本题获证.

3731. 证明: 若函数 $f(x)$ 在闭区间 $[0, l]$ 上连续及当 $0 \leq \xi \leq l$ 时 $(x-\xi)^2 + y^2 + z^2 \neq 0$, 则函数

$$u(x, y, z) = \int_0^l \frac{f(\xi) d\xi}{\sqrt{(x-\xi)^2 + y^2 + z^2}}$$

满足拉普拉斯方程式

$$\frac{\partial^2 u}{\partial x^2} + \frac{\partial^2 u}{\partial y^2} + \frac{\partial^2 u}{\partial z^2} = 0.$$

证 利用积分号下的求导法则, 得

$$\begin{aligned} \frac{\partial u}{\partial x} &= - \int_0^l \frac{2(x-\xi)f(\xi)d\xi}{2[(x-\xi)^2 + y^2 + z^2]^{\frac{3}{2}}} \\ &= - \int_0^l \frac{(x-\xi)f(\xi)d\xi}{[(x-\xi)^2 + y^2 + z^2]^{\frac{3}{2}}}, \end{aligned}$$

$$\frac{\partial^2 u}{\partial x^2} = \int_0^l \frac{f(\xi) \cdot [2(x-\xi)^2 - y^2 - z^2]}{[(x-\xi)^2 + y^2 + z^2]^{\frac{5}{2}}} d\xi. \quad (1)$$

同法可得

$$\frac{\partial^2 u}{\partial y^2} = \int_0^l \frac{f(\xi) \cdot [-(x-\xi)^2 + 2y^2 - z^2]}{[(x-\xi)^2 + y^2 + z^2]^{\frac{5}{2}}} d\xi, \quad (2)$$

$$\frac{\partial^2 u}{\partial z^2} = \int_0^l \frac{f(\xi) \cdot [-(x-\xi)^2 - y^2 + 2z^2]}{[(x-\xi)^2 + y^2 + z^2]^{\frac{5}{2}}} d\xi. \quad (3)$$

将 (1)、(2)、(3) 三式相加, 即证得

$$\frac{\partial^2 u}{\partial x^2} + \frac{\partial^2 u}{\partial y^2} + \frac{\partial^2 u}{\partial z^2} = 0.$$

应用对参数的微分法，计算下列积分：

$$3732. \int_0^{\frac{\pi}{2}} \ln(a^2 \sin^2 x + b^2 \cos^2 x) dx.$$

解 将 b 视为常数， a 视为参变量。令

$$I(a) = \int_0^{\frac{\pi}{2}} \ln(a^2 \sin^2 x + b^2 \cos^2 x) dx.$$

先设 $a > 0$ ， $b > 0$ 。我们有

$$I'(a) = \int_0^{\frac{\pi}{2}} \frac{2a \sin^2 x}{a^2 \sin^2 x + b^2 \cos^2 x} dx,$$

$$\text{若 } a=b, \text{ 有 } I'(b) = \frac{2}{b} \int_0^{\frac{\pi}{2}} \sin^2 x dx = \frac{\pi}{2b}.$$

若 $a \neq b$ ，则作代换 $t = \operatorname{tg} x$ ，得

$$\begin{aligned} I'(a) &= \frac{2}{a} \int_0^{+\infty} \frac{t^2 dt}{(t^2+1) \left(t^2 + \frac{b^2}{a^2}\right)} \\ &= \frac{2}{a} \left(\frac{a^2}{a^2 - b^2} \operatorname{arc} \operatorname{tg} t \right. \\ &\quad \left. - \frac{b^2}{a^2 - b^2} \cdot \frac{a}{b} \operatorname{arc} \operatorname{tg} \frac{at}{b} \right) \Big|_0^{+\infty} \\ &= \frac{\pi}{a+b}. \end{aligned}$$

因此

$$I'(a) = \frac{\pi}{a+b} \quad (0 < a < +\infty).$$

积分之，得

$$I(a) = \pi \ln(a+b) + C \quad (0 < a < +\infty),$$

其中 C 为某常数。令 $a=b$ ，得

$$I(b) = \pi \ln 2b + C,$$

而 $I(b) = \int_0^{\frac{\pi}{2}} \ln b^2 dx = \pi \ln b$ ，代入，解之，得

$$C = \pi \ln \frac{1}{2}. \text{ 于是,}$$

$$I(a) = \pi \ln(a+b) + \pi \ln \frac{1}{2}$$

$$= \pi \ln \frac{a+b}{2} \quad (0 < a < +\infty).$$

若 $a < 0$ 或 $b < 0$ ，则可化为 $a > 0$ 且 $b > 0$ 的情形，得

$$I(a) = \int_0^{\frac{\pi}{2}} \ln(a^2 \sin^2 x + b^2 \cos^2 x) dx$$

$$= \int_0^{\frac{\pi}{2}} \ln(|a|^2 \sin^2 x + |b|^2 \cos^2 x) dx$$

$$= I(|a|) = \pi \ln \frac{|a| + |b|}{2}.$$

于是，不论 a, b 是正是负，在任何情形，均有

$$\int_0^{\frac{\pi}{2}} \ln(a^2 \sin^2 x + b^2 \cos^2 x) dx = \pi \ln \frac{|a| + |b|}{2}.$$

$$3733. \int_0^{\pi} \ln(1 - 2a \cos x + a^2) dx.$$

解 设 $I(a) = \int_0^{\pi} \ln(1 - 2a \cos x + a^2) dx$. 当 $|a| < 1$ 时, 由于 $1 - 2a \cos x + a^2 \geq 1 - 2|a| + a^2 = (1 - |a|)^2 > 0$, 故 $\ln(1 - 2a \cos x + a^2)$ 为连续函数且具有连续导数, 从而可在积分号下求导数. 将 $I(a)$ 对 a 求导数, 得

$$\begin{aligned}
 I'(a) &= \int_0^{\pi} \frac{-2 \cos x + 2a}{1 - 2a \cos x + a^2} dx \\
 &= \frac{1}{a} \int_0^{\pi} \left(1 + \frac{a^2 - 1}{1 - 2a \cos x + a^2} \right) dx \\
 &= \frac{\pi}{a} - \frac{1 - a^2}{a} \int_0^{\pi} \frac{dx}{(1 + a^2) - 2a \cos x} \\
 &= \frac{\pi}{a} - \frac{1 - a^2}{a(1 + a^2)} \int_0^{\pi} \frac{dx}{1 + \left(\frac{-2a}{1 + a^2} \right) \cos x} \\
 &= \frac{\pi}{a} - \frac{2}{a} \operatorname{arc} \operatorname{tg} \left(\frac{1 + a}{1 - a} \operatorname{tg} \frac{x}{2} \right) \Big|_0^{\pi} \\
 &= \frac{\pi}{a} - \frac{2}{a} \cdot \frac{\pi}{2} = 0.
 \end{aligned}$$

于是, 当 $|a| < 1$ 时, $I(a) = C$ (常数). 但是, $I(0) = 0$, 故 $C = 0$. 从而 $I(a) = 0$.

当 $|a| > 1$ 时, 令 $b = \frac{1}{a}$, 则 $|b| < 1$, 并有

$$I(b) = 0.$$

于是, 我们有

$$\begin{aligned}
 I(a) &= \int_0^\pi \ln\left(\frac{b^2 - 2b \cos x + 1}{b^2}\right) dx \\
 &= I(b) - 2\pi \ln|b| \\
 &= -2\pi \ln|b| = 2\pi \ln|a|.
 \end{aligned}$$

当 $|a| = 1$ 时,

$$\begin{aligned}
 I(1) &= \int_0^\pi \ln 2(1 - \cos x) dx \\
 &= \int_0^\pi \left(\ln 4 + 2 \ln \sin \frac{x}{2}\right) dx \\
 &= 2\pi \ln 2 + 4 \int_0^{\frac{\pi}{2}} \ln \sin t dt \\
 &= 2\pi \ln 2 + 4\left(-\frac{\pi}{2} \ln 2\right)^{**)} \\
 &= 0;
 \end{aligned}$$

同法可求得 $I(-1) = 0$.

综上所述, 故知

$$\begin{aligned}
 &\int_0^\pi \ln(1 - 2a \cos x + a^2) dx \\
 &= \begin{cases} 0, & \text{当 } |a| \leq 1; \\ 2\pi \ln|a|, & \text{当 } |a| > 1. \end{cases}
 \end{aligned}$$

*) 利用2028题(a)的结果.

***) 利用2353题(a)的结果.

3734. $\int_0^{\frac{\pi}{2}} \frac{\arctg(a \operatorname{tg} x)}{\operatorname{tg} x} dx.$

解. 令 $I(a) = \int_0^{\frac{\pi}{2}} f(x, a) dx$, 其中 $f(x, a) = \frac{\arctg(a \operatorname{tg} x)}{\operatorname{tg} x}$. 本来 $f(x, a)$ 在 $x=0$ 和 $x = \frac{\pi}{2}$ 时无定义, 但因 $\lim_{x \rightarrow +0} f(x, a) = a$, $\lim_{x \rightarrow \frac{\pi}{2} - 0} f(x, a) = 0$,

故若补充定义 $f(0, a) = a, f(\frac{\pi}{2}, a) = 0$, 则 $f(x, a)$ 为 $0 \leq x \leq \frac{\pi}{2}, -\infty < a < +\infty$ 上的连续函数.

又当 $0 < x < \frac{\pi}{2}, -\infty < a < +\infty$ 时,

$$\begin{aligned} f'_x(x, a) &= \frac{1}{\operatorname{tg} x} \cdot \frac{\operatorname{tg} x}{1 + a^2 \operatorname{tg}^2 x} \\ &= \frac{1}{1 + a^2 \operatorname{tg}^2 x}. \end{aligned}$$

而按规定 $f(0, a) = a, f(\frac{\pi}{2}, a) = 0$, 故

$$f'_x(0, a) = 1, f'_x(\frac{\pi}{2}, a) = 0.$$

由此可知

$$f'_x(x, a) = \begin{cases} \frac{1}{1 + a^2 \operatorname{tg}^2 x}, & \text{当 } 0 \leq x < \frac{\pi}{2}, -\infty < a < +\infty \text{ 时;} \\ 0, & \text{当 } x = \frac{\pi}{2}, -\infty < a < +\infty \text{ 时.} \end{cases}$$

显然 $f_0(x, a)$ 在 $0 \leq x \leq \frac{\pi}{2}$, $0 < a < +\infty$ 上连续,

在 $0 \leq x \leq \frac{\pi}{2}$, $-\infty < a < 0$ 上也连续 (注意, 在点

$x = \frac{\pi}{2}$, $a = 0$ 不连续), 故由积分号下求导数法则知

$$I'(a) = \int_0^{\frac{\pi}{2}} \frac{dx}{1+a^2 \operatorname{tg}^2 x}$$

($0 < a < +\infty$ 或 $-\infty < a < 0$).

作代换 $\operatorname{tg} x = t$, 得 (当 $a^2 \neq 1$ 时)

$$\begin{aligned} & \int_0^{\frac{\pi}{2}} \frac{dx}{1+a^2 \operatorname{tg}^2 x} \\ &= \int_0^{+\infty} \frac{dt}{(1+t^2)(1+a^2 t^2)} \\ &= \frac{1}{1-a^2} \int_0^{+\infty} \left(\frac{1}{1+t^2} - \frac{a^2}{a^2 t^2 + 1} \right) dt \\ &= \frac{\pi}{2(1+|a|)}. \end{aligned}$$

若 $a^2 = 1$, 则

$$\begin{aligned} & \int_0^{\frac{\pi}{2}} \frac{dx}{1+a^2 \operatorname{tg}^2 x} \\ &= \int_0^{\frac{\pi}{2}} \cos^2 x dx = \frac{1}{2} \int_0^{\frac{\pi}{2}} (1 + \cos 2x) dx = \frac{\pi}{4}. \end{aligned}$$

总之, 有

$$I'(a) = \frac{\pi}{2(1+|a|)}$$

($0 < a < +\infty$ 或 $-\infty < a < 0$).

积分之, 得

$$I(a) = \frac{\pi}{2} \ln(1+a) + C_1 \quad (0 < a < +\infty),$$

$$I(a) = -\frac{\pi}{2} \ln(1-a) + C_2 \quad (-\infty < a < 0),$$

其中 C_1, C_2 是两个常数. 由于上面已述 $f(x, a)$ 在 $0 \leq x \leq \frac{\pi}{2}, -\infty < a < +\infty$ 上连续, 故 $I(a)$ 在 $-\infty <$

$a < +\infty$ 上连续, 因此 $\lim_{a \rightarrow 0+0} I(a) = \lim_{a \rightarrow 0-0} I(a) = I(0)$;

但 $I(0) = 0$, $\lim_{a \rightarrow 0+0} I(a) = C_1$, $\lim_{a \rightarrow 0-0} I(a) = C_2$,

故 $C_1 = C_2 = 0$. 于是, 最后得

$$I(a) = \frac{\pi}{2} \operatorname{sgn} a \ln(1+|a|) \quad (-\infty < a < +\infty).$$

3735. $\int_0^{\frac{\pi}{2}} \ln \frac{1+a \cos x}{1-a \cos x} \cdot \frac{dx}{\cos x} \quad (|a| < 1).$

解 解法一

设 $I(a) = \int_0^{\frac{\pi}{2}} \ln \frac{1+a \cos x}{1-a \cos x} \cdot \frac{dx}{\cos x}$. 由于

$$\frac{1+a \cos x}{1-a \cos x} = \frac{1-a^2 \cos^2 x}{1-2a \cos x + a^2 \cos^2 x}$$

$$\geq \frac{1-a^2}{1+2|a|+a^2}$$

$$= \frac{1-a^2}{(1+|a|)^2} > 0,$$

故 $\ln \frac{1+a \cos x}{1-a \cos x}$ 为连续函数. 又由于

$$\begin{aligned} & \lim_{x \rightarrow \frac{\pi}{2}-0} \frac{1}{\cos x} \cdot \ln \frac{1+a \cos x}{1-a \cos x} \\ &= \lim_{t \rightarrow 0} \frac{\ln(1+at) - \ln(1-at)}{t} \\ &= \lim_{t \rightarrow 0} \frac{\frac{a}{1+at} - \frac{-a}{1-at}}{1} = 2a, \end{aligned}$$

今补充被积函数在 $x = \frac{\pi}{2}$ 处的值为 $2a$, 即易知被积函数为连续函数, 且它对 a 有连续导数, 从而可在积分号下求导数, 得

$$\begin{aligned} I'(a) &= \int_0^{\frac{\pi}{2}} \left(\frac{1}{1+a \cos x} + \frac{1}{1-a \cos x} \right) dx \\ &= \frac{2}{\sqrt{1-a^2}} \left[\operatorname{arc} \operatorname{tg} \left(\sqrt{\frac{1-a}{1+a}} \operatorname{tg} \frac{x}{2} \right) \right. \\ &\quad \left. + \operatorname{arc} \operatorname{tg} \left(\sqrt{\frac{1+a}{1-a}} \operatorname{tg} \frac{x}{2} \right) \right] \Big|_0^{\frac{\pi}{2} *} \\ &= \frac{\pi}{\sqrt{1-a^2}}, \end{aligned}$$

从而 $I(a) = \pi \operatorname{arc} \sin a + C$ ($|a| < 1$). 又 $I(0) = 0$, 故 $C = 0$.

于是,

$$\int_0^{\frac{\pi}{2}} \ln \frac{1+a \cos x}{1-a \cos x} \cdot \frac{dx}{\cos x} = \pi \arcsin a \quad (|a| < 1).$$

*) 利用2028题(a)的结果.

解法二

把被积函数表成下述积分形式

$$\frac{1}{\cos x} \cdot \ln \frac{1+a \cos x}{1-a \cos x} = 2a \int_0^1 \frac{dy}{1-a^2 y^2 \cos^2 x}.$$

注意, 此式当 $x = \frac{\pi}{2}$ 时也成立, 此时左端应理解为其极限值

$$\lim_{x \rightarrow \frac{\pi}{2}-0} \frac{1}{\cos x} \cdot \ln \frac{1+a \cos x}{1-a \cos x} = 2a.$$

于是, 当 $a \neq 0$ 时,

$$\begin{aligned} & \int_0^{\frac{\pi}{2}} \ln \frac{1+a \cos x}{1-a \cos x} \cdot \frac{dx}{\cos x} \\ &= 2a \int_0^{\frac{\pi}{2}} dx \int_0^1 \frac{dy}{1-a^2 y^2 \cos^2 x} \\ &= 2a \int_0^1 dy \int_0^{\frac{\pi}{2}} \frac{dx}{1-a^2 y^2 \cos^2 x} \\ &= 2a \int_0^1 \frac{\pi}{2 \sqrt{1-a^2 y^2}} dy \quad (**) \\ &= \pi a \cdot \frac{1}{a} \arcsin ay \Big|_0^1 = \pi \arcsin a. \end{aligned}$$

当 $a = 0$ 时, 原积分显然为零. 因此,

$$\int_0^{\frac{\pi}{2}} \ln \frac{1+a \cos x}{1-a \cos x} \cdot \frac{dx}{\cos x} = \pi \operatorname{arcsin} a \quad (|a| < 1).$$

**) 利用 2028 题(a) 的结果, 即得

$$\begin{aligned} & \int_0^{\frac{\pi}{2}} \frac{dx}{1-a^2 y^2 \cos^2 x} \\ &= \frac{1}{2} \int_0^{\frac{\pi}{2}} \left(\frac{1}{1+ay \cos x} + \frac{1}{1-ay \cos x} \right) dx \\ &= \frac{1}{2} \cdot \frac{2}{\sqrt{1-a^2 y^2}} \left[\operatorname{arc} \operatorname{tg} \left(\sqrt{\frac{1-ay}{1+ay}} \operatorname{tg} \frac{x}{2} \right) \right. \\ & \quad \left. + \operatorname{arc} \operatorname{tg} \left(\sqrt{\frac{1+ay}{1-ay}} \operatorname{tg} \frac{x}{2} \right) \right] \Big|_0^{\frac{\pi}{2}} \\ &= \frac{1}{2} \cdot \frac{2}{\sqrt{1-a^2 y^2}} \cdot \frac{\pi}{2} = \frac{\pi}{2 \sqrt{1-a^2 y^2}}. \end{aligned}$$

3736. 利用公式

$$\frac{\operatorname{arc} \operatorname{tg} x}{x} = \int_0^1 \frac{dy}{1+x^2 y^2},$$

计算积分 $\int_0^1 \frac{\operatorname{arc} \operatorname{tg} x}{x} \cdot \frac{dx}{\sqrt{1-x^2}}$.

解 $\int_0^1 \frac{\operatorname{arc} \operatorname{tg} x}{x} \cdot \frac{dx}{\sqrt{1-x^2}}$

$$= \int_0^1 \frac{dx}{\sqrt{1-x^2}} \int_0^1 \frac{dy}{1+x^2 y^2}.$$

由于函数 $\frac{1}{1+x^2 y^2}$ 在 $0 \leq x \leq 1, 0 \leq y \leq 1$ 上连

续, 且 $\frac{1}{\sqrt{1-x^2}}$ 在 $[0, 1]$ 上绝对可积, 故上述积分号可交换

$$\begin{aligned} & \int_0^1 \frac{\arctg x}{x} \cdot \frac{dx}{\sqrt{1-x^2}} \\ &= \int_0^1 dy \int_0^1 \frac{dx}{\sqrt{1-x^2}(1+x^2y^2)}. \end{aligned} \quad (1)$$

作代换 $x = \cos t$, 可得

$$\begin{aligned} & \int_0^1 \frac{dx}{\sqrt{1-x^2}(1+x^2y^2)} \\ &= \int_0^{\frac{\pi}{2}} \frac{dt}{1+y^2\cos^2 t} \\ &= \frac{1}{\sqrt{1+y^2}} \arctg \left(\frac{\operatorname{tg} t}{\sqrt{1+y^2}} \right) \Big|_0^{\frac{\pi}{2}} \\ &= \frac{\pi}{2\sqrt{1+y^2}}. \end{aligned} \quad (2)$$

于是, 由 (1) 式及 (2) 式即得

$$\begin{aligned} & \int_0^1 \frac{\arctg x}{x} \cdot \frac{dx}{\sqrt{1-x^2}} \\ &= \int_0^1 \frac{\pi dy}{2\sqrt{1+y^2}} = \frac{\pi}{2} \ln(y + \sqrt{1+y^2}) \Big|_0^1 \\ &= \frac{\pi}{2} \ln(1 + \sqrt{2}). \end{aligned}$$

3737. 应用积分符号下的积分法, 计算积分

$$\int_0^1 \frac{x^b - x^a}{\ln x} dx \quad (a > 0, b > 0).$$

解 首先注意, 因为

$$\lim_{x \rightarrow +0} \frac{x^b - x^a}{\ln x} = 0,$$

$$\begin{aligned} \lim_{x \rightarrow 1-0} \frac{x^b - x^a}{\ln x} &= \lim_{x \rightarrow 1-0} \frac{bx^{b-1} - ax^{a-1}}{x^{-1}} \\ &= \lim_{x \rightarrow 1-0} (bx^b - ax^a) = b - a, \end{aligned}$$

故 $\int_0^1 \frac{x^b - x^a}{\ln x} dx$ 不是广义积分, 并且, 如果补充定义被积函数在 $x=0$ 时的值为 0, 在 $x=1$ 时的值为 $b-a$, 则可理解为 $[0, 1]$ 上连续函数的积分. 由于

$$\frac{x^b - x^a}{\ln x} = \int_a^b x^y dy \quad (0 \leq x \leq 1)$$

(注意, $x=0$ 时左端规定为 0, $x=1$ 时左端规定为 $b-a$), 而函数 x^y 在 $0 \leq x \leq 1, a \leq y \leq b$ 上连续 (不妨设 $a \leq b$), 故有

$$\begin{aligned} &\int_0^1 \frac{x^b - x^a}{\ln x} dx \\ &= \int_0^1 dx \int_a^b x^y dy = \int_a^b dy \int_0^1 x^y dx \\ &= \int_a^b \frac{dy}{1+y} = \ln \frac{1+b}{1+a}. \end{aligned}$$

3738. 计算积分:

$$(a) \int_0^1 \sin\left(\ln \frac{1}{x}\right) \frac{x^b - x^a}{\ln x} dx;$$

$$(b) \int_0^1 \cos\left(\ln \frac{1}{x}\right) \frac{x^b - x^a}{\ln x} dx \quad (a > 0, b > 0).$$

解 (a) 不妨设 $a \leq b$.

$$\begin{aligned} & \int_0^1 \sin\left(\ln \frac{1}{x}\right) \frac{x^b - x^a}{\ln x} dx \\ &= \int_0^1 \sin\left(\ln \frac{1}{x}\right) dx \int_a^b x^y dy \\ &= \int_a^b dy \int_0^1 \sin\left(\ln \frac{1}{x}\right) x^y dx, \end{aligned}$$

这里, 当 $x=0$ 时, $\sin\left(\ln \frac{1}{x}\right) x^y$ 理解为零, 从而

$\sin\left(\ln \frac{1}{x}\right) x^y$ 在 $0 \leq x \leq 1, a \leq y \leq b$ 上连续, 故可

应用积分号下的积分法交换积分次序.

作代换 $x=e^{-t}$, 可得

$$\begin{aligned} & \int_0^1 \sin\left(\ln \frac{1}{x}\right) x^y dx \\ &= \int_0^{+\infty} e^{-(y+1)t} \sin t dt \\ &= \frac{1}{1+(1+y)^2} [-(y+1)\sin t \\ & \quad - \cos t] e^{-(y+1)t} \Big|_0^{+\infty} *) \end{aligned}$$

$$= \frac{1}{1+(1+y)^2}.$$

于是, 最后得

$$\begin{aligned} & \int_0^1 \sin\left(\ln \frac{1}{x}\right) \frac{x^b - x^a}{\ln x} dx \\ &= \int_a^b \frac{dy}{1+(1+y)^2} = \operatorname{arc} \operatorname{tg}(1+y) \Big|_a^b \\ &= \operatorname{arc} \operatorname{tg}(1+b) - \operatorname{arc} \operatorname{tg}(1+a) \\ &= \operatorname{arc} \operatorname{tg} \frac{b-a}{1+(1+b)(1+a)}. \end{aligned}$$

(6) 同(a)并利用1828题的结果易得

$$\begin{aligned} & \int_0^1 \cos\left(\ln \frac{1}{x}\right) \frac{x^b - x^a}{\ln x} dx \\ &= \int_a^b dy \int_0^1 \cos\left(\ln \frac{1}{x}\right) x^y dx \\ &= \int_a^b \frac{1+y}{1+(1+y)^2} dy = \frac{1}{2} \ln[1+(1+y)^2] \Big|_a^b \\ &= \frac{1}{2} \ln \frac{b^2+2b+2}{a^2+2a+2}. \end{aligned}$$

*) 利用1829题的结果.

3739. 设 $F(k)$ 和 $E(k)$ 为完全椭圆积分 (参阅问题3725). 证明公式

$$(a) \int_0^k F(k) k dk = E(k) - k^2 F(k);$$

$$(6) \int_0^k E(k)k dk = \frac{1}{3}[(1+k^2)E(k) - k_1^2 F(k)],$$

其中 $k_1^2 = 1 - k^2$.

证 (a) 利用3725题的结果, 可得

$$\begin{aligned} & [E(k) - k_1^2 F(k)]' \\ &= E'(k) + 2k F(k) - (1 - k^2)F'(k) \\ &= \frac{E(k) - F(k)}{k} + 2k F(k) \\ &\quad - (1 - k^2) \left[\frac{E(k)}{k(1 - k^2)} - \frac{F(k)}{k} \right] \\ &= k F(k). \end{aligned}$$

于是,

$$E(k) - k_1^2 F(k) = \int_0^k k F(k) dk + C,$$

其中 C 为常数. 但当 $k=0$ 时, 上式左端为 $E(0) - F(0) = \frac{\pi}{2} - \frac{\pi}{2} = 0$, 而右端等于 C , 故 $C=0$. 最后证得

$$\int_0^k k F(k) dk = E(k) - k_1^2 F(k).$$

(6) 由于

$$\begin{aligned} & \frac{1}{3}[(1+k^2)E(k) - k_1^2 F(k)]' \\ &= \frac{1}{3}[2k E(k) + (1+k^2)E'(k) + 2k F(k)] \end{aligned}$$

$$\begin{aligned}
& -(1-k^2)F'(k)] \\
& = \frac{1}{3} \left\{ 2k E(k) + (1+k^2) \cdot \frac{E(k)-F(k)}{k} \right. \\
& \quad \left. + 2k F(k) - (1-k^2) \cdot \left[\frac{E(k)}{k(1-k^2)} - \frac{F(k)}{k} \right] \right\} \\
& = k E(k),
\end{aligned}$$

故

$$\frac{1}{3} [(1+k^2)E(k) - k^2 F(k)] = \int_0^k k E(k) dk + C,$$

以 $k=0$ 代入上式, 得 $C=0$. 于是, 最后证得

$$\int_0^k k E(k) dk = \frac{1}{3} [(1+k^2)E(k) - k^2 F(k)].$$

3740. 证明公式

$$\int_0^x x J_0(x) dx = x J_1(x),$$

其中 $J_0(x)$ 及 $J_1(x)$ 为足指数是 0 与 1 的贝塞耳函数 (参阅问题 3726) .

$$\begin{aligned}
\text{证} \quad \int_0^x u J_0(u) du &= \frac{1}{\pi} \int_0^x u du \int_0^\pi \cos(-u \sin \varphi) d\varphi \\
&= \frac{1}{\pi} \int_0^x u du \int_0^\pi [\cos(\varphi - u \sin \varphi) \cos \varphi \\
& \quad + \sin(\varphi - u \sin \varphi) \sin \varphi] d\varphi \\
&= \frac{1}{\pi} \int_0^x du \int_0^\pi u \cos(\varphi - u \sin \varphi) \cos \varphi d\varphi \\
& \quad + \frac{1}{\pi} \int_0^x du \int_0^\pi u \sin(\varphi - u \sin \varphi) \sin \varphi d\varphi
\end{aligned}$$

$$\begin{aligned}
&= \frac{1}{\pi} \int_0^x du \int_0^x \cos(\varphi - u \sin \varphi) d(u \sin \varphi) \\
&\quad + \frac{1}{\pi} \int_0^x d\varphi \int_0^x u \sin(\varphi - u \sin \varphi) d(u \sin \varphi - \varphi) \\
&= \frac{1}{\pi} \int_0^x du \int_0^x \cos(\varphi - u \sin \varphi) d(u \sin \varphi - \varphi) \\
&\quad + \frac{1}{\pi} \int_0^x du \int_0^x \cos(\varphi - u \sin \varphi) d\varphi \\
&\quad + \frac{1}{\pi} \int_0^x d\varphi \int_0^x u d \cos(\varphi - u \sin \varphi) \\
&= \frac{1}{\pi} \int_0^x du \int_0^x \cos(\varphi - u \sin \varphi) d\varphi \\
&\quad + \frac{1}{\pi} \int_0^x x \cos(\varphi - x \sin \varphi) d\varphi \\
&\quad - \frac{1}{\pi} \int_0^x d\varphi \int_0^x \cos(\varphi - u \sin \varphi) du \\
&= \frac{1}{\pi} \int_0^x du \int_0^x \cos(\varphi - u \sin \varphi) d\varphi \\
&\quad + \frac{1}{\pi} \int_0^x x \cos(\varphi - x \sin \varphi) d\varphi \\
&\quad - \frac{1}{\pi} \int_0^x du \int_0^x \cos(\varphi - u \sin \varphi) d\varphi \\
&= \frac{1}{\pi} \int_0^x x \cos(\varphi - x \sin \varphi) d\varphi = x J_1(x),
\end{aligned}$$

上述各式中的被积函数显然为 u 及 φ 的二元连续函数，因此，交换积分顺序是合理的，本题获证。

§ 2. 带参数的广义积分. 积分的一致收敛性

1° 一致收敛性的定义 若对于任何的 $\varepsilon > 0$, 都存在有数 $B = B(\varepsilon)$, 使得在 $b \geq B$ 的条件下有

$$\left| \int_b^{+\infty} f(x, y) dx \right| < \varepsilon \quad (y_1 < y < y_2),$$

则称广义积分

$$\int_a^{+\infty} f(x, y) dx \quad (1)$$

(其中函数 $f(x, y)$ 于域 $a \leq x < +\infty$, $y_1 < y < y_2$ 内是连续的) 在区间 (y_1, y_2) 内一致收敛.

积分 (1) 的一致收敛与形状如下的一切级数

$$\sum_{n=0}^{\infty} \int_{a_n}^{a_{n+1}} f(x, y) dx \quad (2)$$

(其中 $a = a_0 < a_1 < a_2 < \dots < a_n < a_{n+1} < \dots$ 且 $\lim_{n \rightarrow \infty} a_n = +\infty$) 的一致收敛等价.

若积分 (1) 在区间 (y_1, y_2) 中一致收敛, 则在这个区间内它是参数 y 的连续函数.

2° 哥西判别法则 积分 (1) 在区间 (y_1, y_2) 内一致收敛的充分而且必要的条件为, 对于任何的 $\varepsilon > 0$ 便存在有数 $B = B(\varepsilon)$, 使得只要是 $b' > B$ 及 $b'' > B$ 则

$$\text{当 } y_1 < y < y_2 \text{ 时 } \left| \int_{b'}^{b''} f(x, y) dx \right| < \varepsilon.$$

3° 外尔什特拉斯判别法 对于积分 (1) 一致收敛的

充分条件为, 与参数 y 无关的强函数 $F(x)$ 存在, 使得

$$(1) \text{ 当 } a \leq x < +\infty \text{ 时 } |f(x, y)| \leq F(x)$$

及

$$(2) \int_a^{+\infty} F(x) dx < +\infty.$$

4° 对于不连续函数的广义积分有类似的定理.

求积分的收敛域:

$$3741. \int_0^{+\infty} \frac{e^{-ax}}{1+x^2} dx.$$

解 当 $a \geq 0$ 时,

$$\frac{e^{-ax}}{1+x^2} \leq \frac{1}{1+x^2}.$$

而积分

$$\int_0^{+\infty} \frac{dx}{1+x^2} = \arctg x \Big|_0^{+\infty} = \frac{\pi}{2},$$

故原积分收敛.

当 $a < 0$ 时, 原积分显然发散. 于是, 积分

$\int_0^{+\infty} \frac{e^{-ax}}{1+x^2} dx$ 的收敛域为 $a \geq 0$ 的一切 a 值.

$$3742. \int_x^{+\infty} \frac{x \cos x}{x^p + x^q} dx.$$

解 首先注意

$$\left(\frac{x}{x^p + x^q} \right)' = \frac{(1-p)x^p + (1-q)x^q}{(x^p + x^q)^2}.$$

若 $\max(p, q) > 1$, 则显然当 x 充分大时, $\left(-\frac{x}{x^p+x^q}\right)' < 0$, 从而当 x 充分大时函数 $\frac{x}{x^p+x^q}$ 是递减的, 并且很明显, 这时

$$\lim_{x \rightarrow +\infty} \frac{x}{x^p+x^q} = 0.$$

又因 $\left| \int_x^A \cos x \, dx \right| = |\sin A| \leq 1$ (对任何 $A > \pi$),

故知 $\int_x^{+\infty} \frac{x \cos x}{x^p+x^q} \, dx$ 收敛.

若 $\max(p, q) \leq 1$, 则恒有 $\left(-\frac{x}{x^p+x^q}\right)' \geq 0$,

故函数 $\frac{x}{x^p+x^q}$ 在 $x \geq \pi$ 上是递增的, 于是, 对于任何正整数 n , 有

$$\begin{aligned} & \int_{2n\pi}^{2n\pi+\frac{\pi}{4}} \frac{x \cos x}{x^p+x^q} \, dx \\ & \geq \frac{\sqrt{2}}{2} \int_{2n\pi}^{2n\pi+\frac{\pi}{4}} \frac{x}{x^p+x^q} \, dx \\ & \geq \frac{\sqrt{2}}{2} \cdot \frac{\pi}{\pi^p+\pi^q} \cdot \frac{\pi}{4} \\ & = \frac{\pi^2 \sqrt{2}}{8(\pi^p+\pi^q)} = \text{常数} > 0, \end{aligned}$$

故不满足柯西收敛准则, 因此积分 $\int_x^{+\infty} \frac{x \cos x}{x^p+x^q} \, dx$

发散.

$$3743. \int_0^{+\infty} \frac{\sin x^q}{x^p} dx.$$

解 若 $q = 0$, 则由于积分 $\int_A^{+\infty} \frac{1}{x^p} dx$ 仅当 $p > 1$ 时收敛, 而积分 $\int_0^A \frac{1}{x^p} dx$ 仅当 $p < 1$ 时收敛, 故积分 $\int_0^{+\infty} \frac{\sin 1}{x^p} dx$ 对于任何的 p 值及 $q = 0$ 发散.

若 $q \neq 0$, 则积分

$$\int_0^{+\infty} \frac{\sin x^q}{x^p} dx = \int_0^{+\infty} x^{-p} \sin x^q dx,$$

利用 2380 题的结果即知: 当 $\left| \frac{1-p}{q} \right| < 1$ 时, 原积分收敛.

$$3744. \int_0^2 \frac{dx}{|\ln x|^p}.$$

解 考虑积分

$$\begin{aligned} \int_0^1 \frac{dx}{|\ln x|^p} &= \int_0^1 \frac{dx}{\ln^p\left(\frac{1}{x}\right)} \\ &= \int_0^1 \ln^{-p}\left(\frac{1}{x}\right) dx, \end{aligned}$$

利用 2362 题的结果即知: 它当 $-p > -1$ 或 $p < 1$ 时收敛.

再考虑积分

$$\int_1^2 \frac{dx}{|\ln x|^p} = \int_1^2 \frac{dx}{\ln^p x}.$$

由于

$$\begin{aligned} \lim_{x \rightarrow 1+0} (x-1)^p \cdot \frac{1}{\ln^p x} &= \left[\lim_{x \rightarrow 1+0} \frac{x-1}{\ln x} \right]^p \\ &= \left[\lim_{x \rightarrow 1+0} \frac{1}{x^{-1}} \right]^p = 1, \end{aligned}$$

故积分 $\int_1^2 \frac{dx}{\ln^p x}$ 与积分 $\int_1^2 \frac{dx}{(x-1)^p}$ 具有相同的敛散性，而后者显然当 $p < 1$ 时收敛， $p \geq 1$ 时发散，从而前者亦然。

于是，仅当 $p < 1$ 时，积分

$$\int_0^2 \frac{dx}{|\ln x|^p}$$

收敛。

3745.
$$\int_0^1 \frac{\cos \frac{1}{1-x}}{\sqrt[n]{1-x^2}} dx.$$

解
$$\int_0^1 \frac{\cos \frac{1}{1-x}}{\sqrt[n]{1-x^2}} dx = \int_0^1 \frac{\cos \frac{1}{1-x}}{\sqrt[n]{1-x} \cdot \sqrt[n]{1+x}} dx.$$

由于当 $0 \leq x \leq 1$ 时，对于任意的 n ， $\sqrt[n]{1+x}$ 与 $\frac{1}{\sqrt[n]{1-x}}$ 都是单调有界函数，故原积分与积分

$$\int_0^1 \frac{\cos \frac{1}{1-x}}{\sqrt[n]{1-x}} dx$$

同敛散. 对此积分作代换 $t = \frac{1}{1-x}$, 则得

$$\int_0^1 \frac{\cos \frac{1}{1-x}}{\sqrt[n]{1-x}} dx = \int_1^{+\infty} \frac{\cos t}{t^{2-\frac{1}{n}}} dt.$$

易知积分 $\int_1^{+\infty} \frac{\cos t}{t^a} dt$ 仅当 $a > 0$ 时收敛. 事实上, 当 $a > 0$ 时它显然收敛. 当 $a = 0$ 时它显然发散. 当 $a < 0$ 时, 令 $\beta = -a$ ($\beta > 0$), 则对于正整数 n 有

$$\begin{aligned} & \int_{2n\pi}^{2n\pi + \frac{\pi}{4}} t^\beta \cos t dt \\ & \geq (2n\pi)^\beta \cdot \frac{1}{\sqrt{2}} \cdot \frac{\pi}{4} \rightarrow +\infty \quad (n \rightarrow \infty), \end{aligned}$$

故积分 $\int_1^{+\infty} t^\beta \cos t dt$ 发散.

于是, 积分

$$\int_0^1 \frac{\cos \frac{1}{1-x}}{\sqrt[n]{1-x^2}} dx$$

仅当 $2 - \frac{1}{n} > 0$ 时收敛, 即仅当 $n < 0$ 或 $n > \frac{1}{2}$ 时收敛.

$$3746. \int_0^{+\infty} \frac{\sin x}{x^p + \sin x} dx \quad (p > 0).$$

解 因为

$$\begin{aligned} \lim_{x \rightarrow +0} \frac{\sin x}{x^p + \sin x} &= \lim_{x \rightarrow +0} \frac{\frac{\sin x}{x}}{x^{p-1} + \frac{\sin x}{x}} \\ &= \begin{cases} 1, & \text{当 } p > 1 \text{ 时;} \\ \frac{1}{2}, & \text{当 } p = 1 \text{ 时;} \\ 0, & \text{当 } 0 < p < 1 \text{ 时,} \end{cases} \end{aligned}$$

故 $x = 0$ 不是积分 $\int_0^{+\infty} \frac{\sin x}{x^p + \sin x} dx$ 的瑕点, 因此,

只要讨论积分 $\int_2^{+\infty} \frac{\sin x}{x^p + \sin x} dx$ ($p > 0$) 的敛散性.

由于

$$\frac{\sin x}{x^p + \sin x} = \frac{\sin x}{x^p} - \frac{\sin^2 x}{x^p(x^p + \sin x)},$$

而 $\int_2^{+\infty} \frac{\sin x}{x^p} dx$ 收敛 (当 $p > 0$ 时), 故只要讨论

$$\int_2^{+\infty} \frac{\sin^2 x}{x^p(x^p + \sin x)} dx$$

的敛散性. 但当 $p > 0$, $x \geq 2$ 时,

$$0 \leq \frac{1}{2} \left[\frac{1}{x^p(x^p + 1)} - \frac{\cos 2x}{x^p(x^p + 1)} \right]$$

$$= \frac{\sin^2 x}{x^p(x^p + 1)} \leq \frac{\sin^2 x}{x^p(x^p + \sin x)}$$

$$\leq \frac{\sin^2 x}{x^p(x^p-1)} \leq \frac{1}{x^p(x^p-1)}.$$

而易知 $\int_2^{+\infty} \frac{\cos 2x}{x^p(x^p+1)} dx$ 恒收敛 (当 $p > 0$ 时), 积

分 $\int_2^{+\infty} \frac{dx}{x^p(x^p+1)}$ 当 $0 < p \leq \frac{1}{2}$ 时发散, 积分

$\int_2^{+\infty} \frac{dx}{x^p(x^p-1)}$ 当 $p > \frac{1}{2}$ 时收敛, 故积分

$\int_2^{+\infty} \frac{\sin^2 x}{x^p(x^p+\sin x)} dx$ 当 $p > \frac{1}{2}$ 时收敛, 当 $0 < p$

$\leq \frac{1}{2}$ 时发散. 由此可知, 积分 $\int_0^{+\infty} \frac{\sin x}{x^p+\sin x} dx$

($p > 0$) 仅当 $p > \frac{1}{2}$ 时收敛.

利用与级数比较的方法研究下列积分的收敛性:

3747. $\int_0^{+\infty} \frac{\cos x}{x+a} dx.$

解 设 $a > 0$. 我们证明: 对任何数列

$$0 = a_0 < a_1 < a_2 < \dots < a_n < \dots \quad (a_n \rightarrow +\infty),$$

级数 $\sum_{n=0}^{\infty} \int_{a_n}^{a_{n+1}} \frac{\cos x}{x+a} dx$ 都收敛. 事实上, 有

$$\begin{aligned} & \int_{a_n}^{a_{n+1}} \frac{\cos x}{x+a} dx \\ &= \frac{\sin x}{x+a} \Big|_{a_n}^{a_{n+1}} + \int_{a_n}^{a_{n+1}} \frac{\sin x}{(x+a)^2} dx, \end{aligned}$$

故

$$\begin{aligned} & \sum_{n=m}^{m+p-1} \int_{a_n}^{a_{n+1}} \frac{\cos x}{x+a} dx \\ &= \frac{\sin a_{m+p}}{a_{m+p}+a} - \frac{\sin a_m}{a_m+a} + \int_{a_m}^{a_{m+p}} \frac{\sin x}{(x+a)^2} dx, \end{aligned}$$

从而

$$\begin{aligned} & \left| \sum_{n=m}^{m+p-1} \int_{a_n}^{a_{n+1}} \frac{\cos x}{x+a} dx \right| \\ & \leq \frac{1}{a_{m+p}+a} + \frac{1}{a_m+a} + \int_{a_m}^{a_{m+p}} \frac{dx}{(x+a)^2} \\ &= \frac{1}{a_{m+p}+a} + \frac{1}{a_m+a} + \left(\frac{1}{a_m+a} - \frac{1}{a_{m+p}+a} \right) \\ &= \frac{2}{a_m+a}, \end{aligned}$$

由此可知，满足柯西收敛准则，从而级数

$\sum_{n=0}^{\infty} \int_{a_n}^{a_{n+1}} \frac{\cos x}{x+a} dx$ 收敛，因此，积分 $\int_0^{+\infty} \frac{\cos x}{x+a} dx$ 收敛。

若 $a=0$ ，显然瑕积分 $\int_0^{\frac{\pi}{2}} \frac{\cos x}{x} dx$ 发散，故广

义积分 $\int_0^{+\infty} \frac{\cos x}{x} dx$ 发散。

下设 $a < 0$ 。若 $a = -\left(n + \frac{1}{2}\right)\pi$ ($n=0, 1, 2, \dots$)，

则

$$\begin{aligned}
& \int_0^{+\infty} \frac{\cos x}{x+a} dx \\
&= \int_0^{(n+1)\pi} \frac{\cos x}{x+a} dx + \int_{(n+1)\pi}^{+\infty} \frac{\cos x}{x+a} dx \\
&= \int_0^{(n+1)\pi} \frac{\cos x}{x+a} dx + (-1)^{n+1} \int_0^{+\infty} \frac{\cos t}{t+\frac{\pi}{2}} dt.
\end{aligned}$$

由上所证，右端第二个积分收敛；又由于

$$\lim_{x \rightarrow (n+\frac{1}{2})\pi} \frac{\cos x}{x+a} = (-1)^{n+1},$$

故右端第一个积分收敛（它不是广义积分，补充定义被积函数在 $x = (n + \frac{1}{2})\pi$ 时的值为 $(-1)^{n+1}$ 后即为

连续函数的积分）；从而，此时积分 $\int_0^{+\infty} \frac{\cos x}{x+a} dx$ 收敛。

若 $a < 0$ 但 $a \neq -(n + \frac{1}{2})\pi$ ($n=0, 1, 2, \dots$)，此时 $\cos(-a) \neq 0$ 。由连续性，可取 $\delta > 0$ ，使当 $-a \leq x \leq -a + \delta$ 时 $\cos x$ 保持定号且

$$|\cos x| \geq \frac{1}{2} |\cos(-a)|.$$

于是，

$$\begin{aligned}
& \left| \int_{-a}^{-a+\delta} \frac{\cos x}{x+a} dx \right| \\
& \geq \frac{1}{2} |\cos(-a)| \cdot \int_{-a}^{-a+\delta} \frac{dx}{x+a} = +\infty.
\end{aligned}$$

由此可知, 瑕积分 $\int_{-a}^{-a+b} \frac{\cos x}{x+a} dx$ 发散. 从而积分

$$\int_0^{+\infty} \frac{\cos x}{x+a} dx \text{ 更是发散.}$$

综上所述, 积分

$$\int_0^{+\infty} \frac{\cos x}{x+a} dx$$

仅当 $a > 0$ 及 $a = -\left(n + \frac{1}{2}\right)\pi$ ($n = 0, 1, 2, \dots$) 时收敛.

3748. $\int_0^{+\infty} \frac{x dx}{1+x^n \sin^2 x}$ ($n > 0$).

解 由于被积函数非负, 故只要考虑化为一种特殊的 (正项) 级数即可. 我们有

$$\begin{aligned} & \int_0^{+\infty} \frac{x dx}{1+x^n \sin^2 x} dx \\ &= \int_0^{\frac{\pi}{4}} \frac{x dx}{1+x^n \sin^2 x} \\ & \quad + \sum_{k=1}^{\infty} \int_{(k-1)\pi + \frac{\pi}{4}}^{k\pi - \frac{\pi}{4}} \frac{x dx}{1+x^n \sin^2 x} \\ & \quad + \sum_{k=1}^{\infty} \int_{k\pi - \frac{\pi}{4}}^{k\pi + \frac{\pi}{4}} \frac{x dx}{1+x^n \sin^2 x}. \end{aligned}$$

又积分

$$0 < \int_{(k-1)\pi + \frac{\pi}{4}}^{k\pi - \frac{\pi}{4}} \frac{x dx}{1+x^n \sin^2 x}$$

$$\int_{(k-1)\pi + \frac{\pi}{4}}^{k\pi - \frac{\pi}{4}} \frac{k\pi dx}{1 + [(k-1)\pi]^n \sin^2 x},$$

$$\int_{k\pi - \frac{\pi}{4}}^{k\pi + \frac{\pi}{4}} \frac{(k-1)\pi dx}{1 + [(k+1)\pi]^n \sin^2 x}$$

$$\int_{k\pi - \frac{\pi}{4}}^{k\pi + \frac{\pi}{4}} \frac{x dx}{1 + x^n \sin^2 x}$$

$$\int_{k\pi - \frac{\pi}{4}}^{k\pi + \frac{\pi}{4}} \frac{(k+1)\pi dx}{1 + [(k-1)\pi]^n \sin^2 x},$$

II

$$\int_{(k-1)\pi + \frac{\pi}{4}}^{k\pi - \frac{\pi}{4}} \frac{dx}{1 + a^2 \sin^2 x}$$

$$= \frac{-1}{\sqrt{1+a^2}} \operatorname{arctg} \left(\frac{\operatorname{ctg} x}{\sqrt{1+a^2}} \right) \Big|_{(k-1)\pi + \frac{\pi}{4}}^{k\pi - \frac{\pi}{4}}$$

$$= \frac{2}{\sqrt{1+a^2}} \operatorname{arctg} \frac{1}{\sqrt{1+a^2}} \leftarrow \frac{2}{\sqrt{1+a^2}} \cdot \frac{\pi}{4}$$

$$= \frac{\pi}{2\sqrt{1+a^2}},$$

$$\int_{k\pi - \frac{\pi}{4}}^{k\pi + \frac{\pi}{4}} \frac{dx}{1 + a^2 \sin^2 x}$$

$$= \frac{1}{\sqrt{1+a^2}} \operatorname{arctg} (\sqrt{1+a^2} \operatorname{tg} x) \Big|_{k\pi - \frac{\pi}{4}}^{k\pi + \frac{\pi}{4}}$$

$$= \frac{2}{\sqrt{1+a^2}} \operatorname{arctg} \sqrt{1+a^2}.$$

由于

$$\frac{\pi}{4} < \arctg \sqrt{1+a^2} < \frac{\pi}{2},$$

从而

$$\frac{\pi}{2\sqrt{1+a^2}} < \int_{x-\frac{\pi}{4}}^{x+\frac{\pi}{4}} \frac{dx}{1+a^2 \sin^2 x} < \frac{\pi}{\sqrt{1+a^2}}.$$

于是,

$$\begin{aligned} 0 &< \int_{(k-1)\pi+\frac{\pi}{4}}^{k\pi-\frac{\pi}{4}} \frac{x dx}{1+x^n \sin^2 x} \\ &< \frac{k\pi^2}{2\sqrt{1+[(k-1)\pi]^n}}, \\ &\frac{(k-1)\pi^2}{2\sqrt{1+[(k+1)\pi]^n}} \\ &< \int_{k\pi-\frac{\pi}{4}}^{(k+1)\pi+\frac{\pi}{4}} \frac{x dx}{1+x^n \sin^2 x} < \frac{(k+1)\pi^2}{\sqrt{1+[(k-1)\pi]^n}}. \end{aligned}$$

由于当 $n > 4$ 时, 级数 $\sum_{k=1}^{\infty} \frac{k\pi^2}{2\sqrt{1+[(k-1)\pi]^n}}$ 及

$\sum_{k=1}^{\infty} \frac{(k+1)\pi^2}{\sqrt{1+[(k-1)\pi]^n}}$ 收敛; 而当 $n \leq 4$ 时, 级数

$\sum_{k=1}^{\infty} \frac{(k-1)\pi^2}{2\sqrt{1+[(k+1)\pi]^n}}$ 发散, 故级数

$$\sum_{k=1}^{\infty} \int_{(k-1)\pi+\frac{\pi}{4}}^{k\pi-\frac{\pi}{4}} \frac{x dx}{1+x^n \sin^2 x}$$

当 $n > 4$ 时收敛, 而级数

$$\sum_{k=1}^{\infty} \int_{k\pi - \frac{\pi}{4}}^{k\pi + \frac{\pi}{4}} \frac{x dx}{1+x^n \sin^2 x}$$

仅当 $n \geq 4$ 时收敛。

因此，积分

$$\int_0^{+\infty} \frac{x dx}{1+x^n \sin^2 x}$$

仅当 $n \geq 4$ 时收敛。

3749.
$$\int_{\pi}^{+\infty} \frac{dx}{x^p \sqrt[3]{\sin^2 x}}.$$

解 由于被积函数非负，故只要考虑化为一种特殊的（正项）级数即可。我们有

$$\begin{aligned} & \int_{\pi}^{+\infty} \frac{dx}{x^p \sqrt[3]{\sin^2 x}} \\ &= \sum_{n=1}^{\infty} \int_{n\pi}^{(n+1)\pi} \frac{dx}{x^p \sqrt[3]{\sin^2 x}} \\ &= \sum_{n=1}^{\infty} \int_0^{\pi} \frac{dx}{(x+n\pi)^p \sqrt[3]{\sin^2 x}}. \end{aligned}$$

于是，

$$\begin{aligned} & \int_0^{\pi} \frac{dx}{\sqrt[3]{\sin^2 x}} \cdot \sum_{n=1}^{\infty} \frac{1}{(n+1)^p \pi^p} \\ & \leq \int_{\pi}^{+\infty} \frac{dx}{x^p \sqrt[3]{\sin^2 x}} \\ & \leq \int_0^{\pi} \frac{dx}{\sqrt[3]{\sin^2 x}} \cdot \sum_{n=1}^{\infty} \frac{1}{n^p \pi^p}. \end{aligned}$$

易证积分

$$\int_0^{\pi} \frac{dx}{\sqrt[3]{\sin^2 x}}$$

收敛，且级数

$$\sum_{n=1}^{\infty} \frac{1}{n^p}$$

当 $p > 1$ 时收敛；当 $p \leq 1$ 时发散。因此，原积分仅当 $p > 1$ 时收敛。

3750. $\int_0^{+\infty} \frac{\sin(x+x^2)}{x^n} dx .$

解 我们有

$$\begin{aligned} & \int_0^{+\infty} \frac{\sin(x+x^2)}{x^n} dx \\ &= \int_0^1 \frac{\sin(x+x^2)}{x^n} dx + \int_1^{+\infty} \frac{\sin(x+x^2)}{x^n} dx . \end{aligned}$$

易知右端第一个积分($x=0$ 可能是瑕点)当 $n < 2$ 时收敛, 当 $n \geq 2$ 时发散. 下面研究右端第二个积分. 先设 $n > -1$. 对任何数列

$$1 = a_0 < a_1 < \dots < a_k < \dots \quad (a_k \rightarrow +\infty),$$

$$\begin{aligned} & \int_{a_k}^{a_{k+1}} \frac{\sin(x+x^2)}{x^n} dx \\ &= - \int_{a_k}^{a_{k+1}} \frac{d[\cos(x+x^2)]}{x^n(1+2x)} \\ &= - \frac{\cos(x+x^2)}{x^n(1+2x)} \Big|_{a_k}^{a_{k+1}} \end{aligned}$$

$$- \int_{a_k}^{a_{k+1}} \frac{[2(n+1)x+n]\cos(x+x^2)}{x^{n+1}(1+2x)^2} dx,$$

故

$$\begin{aligned} & \sum_{k=m}^{m+p-1} \int_{a_k}^{a_{k+1}} \frac{\sin(x+x^2)}{x^n} dx \\ &= - \frac{\cos(x+x^2)}{x^n(1+2x)} \Big|_{a_m}^{a_{m+p}} \\ &= - \int_{a_m}^{a_{m+p}} \frac{[2(n+1)x+n]\cos(x+x^2)}{x^{n+1}(1+2x)^2} dx, \end{aligned}$$

从而

$$\begin{aligned} & \left| \sum_{k=m}^{m+p-1} \int_{a_k}^{a_{k+1}} \frac{\sin(x+x^2)}{x^n} dx \right| \\ & \leq \frac{1}{2a_m^{n+1}} + \frac{1}{2a_{m+p}^{n+1}} + \int_{a_m}^{a_{m+p}} \frac{2(n+1)x+|n|}{x^{n+1}(1+2x)^2} dx. \end{aligned}$$

易知积分 $\int_1^{+\infty} \frac{2(n+1)x+|n|}{x^{n+1}(1+2x)^2} dx$ 收敛 (因为

$$\lim_{x \rightarrow +\infty} x^{n+2} \cdot \frac{2(n+1)x+|n|}{x^{n+1}(1+2x)^2} = \frac{n+1}{2} > 0,$$

$n+2 > 1$) .

由此可知, 对任给的 $\varepsilon > 0$, 必存在 N , 使当 $n > N$ 时, 对 $p=1, 2, 3, \dots$, 均有

$$\left| \sum_{k=m}^{m+p-1} \int_{a_k}^{a_{k+1}} \frac{\sin(x+x^2)}{x^n} dx \right| < \varepsilon.$$

于是, 根据柯西收敛准则, 级数

$$\sum_{k=0}^{\infty} \int_{a_k}^{a_{k+1}} \frac{\sin(x+x^2)}{x^n} dx$$

收敛，从而积分 $\int_1^{+\infty} \frac{\sin(x+x^2)}{x^n} dx$ 收敛。

再设 $n \leq -1$ ，令 ξ_k 和 η_k 分别表方程 $x^2+x=2k\pi+\frac{\pi}{4}$ 和 $x^2+x=2k\pi+\frac{\pi}{2}$ 的（唯一）正根，其中 $k=1, 2, 3, \dots$ ；即令

$$\xi_k = \frac{1}{2}(\sqrt{1+8k\pi+\pi} - 1),$$

$$\eta_k = \frac{1}{2}(\sqrt{1+8k\pi+2\pi} - 1).$$

于是 $\eta_k > \xi_k \rightarrow +\infty$ （当 $k \rightarrow \infty$ 时），我们有（注意 $-n \geq 1$ ）

$$\begin{aligned} & \int_{\xi_k}^{\eta_k} \frac{\sin(x+x^2)}{x^n} dx \\ & \geq \frac{1}{\sqrt{2}} \int_{\xi_k}^{\eta_k} x^{-n} dx \geq \frac{1}{\sqrt{2}} \int_{\xi_k}^{\eta_k} x dx \\ & \geq \frac{1}{\sqrt{2}} \xi_k (\eta_k - \xi_k) \\ & = \frac{\pi}{4\sqrt{2}} \cdot \frac{\sqrt{1+8k\pi+\pi} - 1}{\sqrt{1+8k\pi+2\pi} + \sqrt{1+8k\pi+\pi}} \\ & \rightarrow \frac{\pi}{8\sqrt{2}} \quad (\text{当 } k \rightarrow \infty \text{ 时}). \end{aligned}$$

由此可知，此时积分 $\int_1^{+\infty} \frac{\sin(x+x^2)}{x^n} dx$ 发散。

综上所述，积分

$$\int_0^{+\infty} \frac{\sin(x+x^2)}{x^n} dx$$

仅当 $-1 < n < 2$ 时收敛。

3751. 在肯定的意义上表达出来，甚么是积分

$$\int_a^{+\infty} f(x, y) dx$$

在已知区间 (y_1, y_2) 内不一致收敛？

解 若对于某个正数 ε_0 ，不论 B 取得多大，恒存在 $b_0 \geq B$ 以及 $y_0 \in (y_1, y_2)$ (b_0 与 y_0 都依赖于 B)，使得

$$\left| \int_{b_0}^{+\infty} f(x, y_0) dx \right| \geq \varepsilon_0,$$

则 $\int_a^{+\infty} f(x, y) dx$ 在区间 (y_1, y_2) 内不一致收敛。

3752. 证明：若 1) 积分

$$\int_a^{+\infty} f(x) dx$$

收敛，2) 函数 $\varphi(x, y)$ 有界并关于 x 是单调的，则积分

$$\int_a^{+\infty} f(x) \varphi(x, y) dx$$

一致收敛（在对应的域内）。

证 设 $|\varphi(x, y)| \leq L$ ，则由题设 1) 知：对于任给的 $\varepsilon > 0$ ，总存在数 $B = B(\varepsilon)$ ，使当 $A' > A > B$ 时，就

有不等式

$$\left| \int_A^{A'} f(x) dx \right| < \frac{\varepsilon}{2L}. \quad (1)$$

由积分第二中值定理知：存在 $\xi \in [A, A']$ ，使有下述等式

$$\begin{aligned} & \int_A^{A'} f(x)\varphi(x, y)dx \\ &= \varphi(A+0, y) \cdot \int_A^{\xi} f(x)dx \\ & \quad + \varphi(A'-0, y) \cdot \int_{\xi}^{A'} f(x)dx. \end{aligned} \quad (2)$$

由 (1) 式，得

$$\left| \int_A^{\xi} f(x)dx \right| < \frac{\varepsilon}{2L}, \quad \left| \int_{\xi}^{A'} f(x)dx \right| < \frac{\varepsilon}{2L}.$$

于是，由 (2) 式，可得

$$\begin{aligned} & \left| \int_A^{A'} f(x)\varphi(x, y)dx \right| \\ & < L \cdot \frac{\varepsilon}{2L} + L \cdot \frac{\varepsilon}{2L} = \varepsilon, \end{aligned}$$

即积分 $\int_a^{+\infty} f(x)\varphi(x, y)dx$ 在对应的 y 域内一致收敛。

3753. 证明：一致收敛的积分

$$I = \int_1^{+\infty} e^{-\frac{1}{y^2} \left(x - \frac{1}{y}\right)^2} dx \quad (0 < y < 1)$$

不能以与参数无关的收敛积分为强函数。

证 任给 $\varepsilon > 0$ 。取 $A_0 > 1$ 充分大，使

$$\int_{A_0 - \frac{\sqrt{x}}{\varepsilon}}^{+\infty} e^{-u^2} du < \varepsilon.$$

下证：当 $A > A_0$ 时，对一切 $0 < y < 1$ ，均有

$$\int_A^{+\infty} e^{-\frac{1}{y^2} \left(x - \frac{1}{y}\right)^2} dx < \varepsilon.$$

事实上，当 $\frac{\varepsilon}{\sqrt{\pi}} \leq y < 1$ 时，

$$\begin{aligned} \int_A^{+\infty} e^{-\frac{1}{y^2} \left(x - \frac{1}{y}\right)^2} dx &< \int_A^{+\infty} e^{-\left(x - \frac{1}{y}\right)^2} dx \\ &= \int_{A - \frac{1}{y}}^{+\infty} e^{-u^2} du \leq \int_{A - \frac{\sqrt{x}}{\varepsilon}}^{+\infty} e^{-u^2} du \\ &< \int_{A_0 - \frac{\sqrt{x}}{\varepsilon}}^{+\infty} e^{-u^2} du < \varepsilon; \end{aligned}$$

当 $0 < y < \frac{\varepsilon}{\sqrt{\pi}}$ 时，

$$\begin{aligned} &\int_A^{+\infty} e^{-\frac{1}{y^2} \left(x - \frac{1}{y}\right)^2} dx \\ &< \int_1^{+\infty} e^{-\frac{1}{y^2} \left(x - \frac{1}{y}\right)^2} dx \\ &= \int_1^{\frac{1}{y}} e^{-\frac{1}{y^2} \left(x - \frac{1}{y}\right)^2} dx \end{aligned}$$

$$\begin{aligned}
& + \int_{\frac{1}{y}}^{+\infty} e^{-\frac{1}{y^2} \left(x - \frac{1}{y}\right)^2} dx \\
& = \int_0^{\frac{1}{y}-1} e^{-\frac{1}{y^2} t^2} dt + \int_0^{+\infty} e^{-\frac{1}{y^2} t^2} dt \\
& < 2 \int_0^{+\infty} e^{-\frac{t^2}{y^2}} dt = 2y \int_0^{+\infty} e^{-u^2} du \\
& = 2y \cdot \frac{\sqrt{\pi}}{2} < \varepsilon.
\end{aligned}$$

由此可知，积分 $\int_1^{+\infty} e^{-\frac{1}{y^2} \left(x - \frac{1}{y}\right)^2} dx$ 在 $0 < y < 1$ 上一致收敛。

最后证明，不存在这样的函数 $\varphi(x)$ ($x \geq 1$)，使

$$\begin{aligned}
0 < e^{-\frac{1}{y^2} \left(x - \frac{1}{y}\right)^2} \leq \varphi(x) \\
(x \geq 1, 0 < y < 1), \quad (1)
\end{aligned}$$

并且 $\int_1^{+\infty} \varphi(x) dx$ 收敛。用反证法。假定有这样的函数

$\varphi(x)$ 存在，则由 $\int_1^{+\infty} \varphi(x) dx$ 的收敛性可知，必

存在点 $x_0 > 1$ 使 $\varphi(x_0) < 1$ 。于是，令 $y_0 = \frac{1}{x_0}$ ，

则 $0 < y_0 < 1$ 且

$$e^{-\frac{1}{y_0^2} \left(x_0 - \frac{1}{y_0}\right)^2} = 1 > \varphi(x_0),$$

此显然与 (1) 式矛盾。由此可知，一致收敛的积分

I 的被积函数不能以与参数 y 无关的具收敛积分的函数为强函数。证毕。

3754. 证明：积分

$$I = \int_0^{+\infty} \alpha e^{-\alpha x} dx$$

1) 在任何区间 $0 < a \leq \alpha \leq b$ 内一致收敛；2) 在区间 $0 \leq \alpha \leq b$ 内非一致收敛。

证 显然，积分 I 对于每一个定值 $\alpha \geq 0$ 是收敛的。

事实上，当 $\alpha = 0$ 时， $\int_0^{+\infty} \alpha e^{-\alpha x} dx = 0$ ；当 $\alpha > 0$

时， $\int_0^{+\infty} \alpha e^{-\alpha x} dx = -e^{-\alpha x} \Big|_0^{+\infty} = 1$ 。

1) 如果 $0 < a \leq \alpha \leq b$ ，则由于

$$0 < \int_A^{+\infty} \alpha e^{-\alpha x} dx = e^{-\alpha A} \leq e^{-aA},$$

故对于任给的 $\varepsilon > 0$ ，可以找到不依赖于 α 的数

$A_0 = \frac{1}{a} \ln \frac{1}{\varepsilon}$ ，使当 $A > A_0$ 时，就有

$$\int_A^{+\infty} \alpha e^{-\alpha x} dx < e^{-aA_0} = \varepsilon.$$

于是，在区间 $0 < a \leq \alpha \leq b$ 上积分 I 一致收敛。

2) 如果 $0 \leq \alpha \leq b$ ，则不存在这样的数 A_0 。事实上，取 $0 < \varepsilon < 1$ 就办不到。由于当 $\alpha \rightarrow +0$ 时， $e^{-A\alpha} \rightarrow 1$ ，故对于足够小的 α 值， $e^{-A\alpha}$ 就比任意一个小于 1 的数 ε 为大。因此，在区间 $0 \leq \alpha \leq b$ 上，积

分 I 对 α 的收敛是不一致的。

3755. 证明迪里黑里积分

$$I = \int_0^{+\infty} \frac{\sin \alpha x}{x} dx$$

1) 在每一个不含数值 $\alpha = 0$ 的闭区间 $[a, b]$ 上一致收敛, 2) 在含数值 $\alpha = 0$ 的每一个闭区间 $[a, b]$ 上非一致收敛。

证 不失一般性, 我们只考虑 α 的正值。

1) 由于积分

$$\int_0^{+\infty} \frac{\sin z}{z} dz = \frac{\pi}{2}$$

是收敛的, 故对于任给的 $\varepsilon > 0$, 存在数 A_0 , 使当 $A > A_0$ 时, 恒有

$$\left| \int_A^{+\infty} \frac{\sin z}{z} dz \right| < \varepsilon.$$

当 $\alpha > 0$ 时, 由于

$$\int_A^{+\infty} \frac{\sin \alpha x}{x} dx = \int_{A\alpha}^{+\infty} \frac{\sin z}{z} dz,$$

故取 $A > \frac{A_0}{\alpha}$, 对于 $\alpha \geq a > 0$, 就有

$$\left| \int_A^{+\infty} \frac{\sin \alpha x}{x} dx \right| < \varepsilon.$$

于是, 在区间 $0 < a \leq \alpha \leq b$ 上, 积分 I 是一致收敛的。

2) 对于任何的 $A > 0$, 当 $\alpha \rightarrow +0$ 时,

$$\int_A^{+\infty} \frac{\sin ax}{x} dx$$

$$= \int_{Aa}^{+\infty} \frac{\sin z}{z} dz \rightarrow \int_0^{+\infty} \frac{\sin z}{z} dz = \frac{\pi}{2}.$$

因此, 当 $a > 0$ 且充分小时, 有

$$\int_A^{+\infty} \frac{\sin ax}{x} dx > \frac{\pi}{4}.$$

于是, 在区间 $0 \leq a \leq b$ ($b > 0$) 上, 积分 I 不一致收敛.

研究下列积分在所指定区间内的一致收敛性:

3756. $\int_0^{+\infty} e^{-ax} \sin x dx \quad (0 < a_0 \leq a < +\infty).$

解 由于当 $0 < a_0 \leq a < +\infty$ 时,

$$|e^{-ax} \sin x| \leq e^{-a_0 x},$$

且积分 $\int_0^{+\infty} e^{-a_0 x} dx = \frac{1}{a_0}$ 收敛, 故积分

$$\int_0^{+\infty} e^{-ax} \sin x dx$$

在区间 $0 < a_0 \leq a < +\infty$ 上一致收敛.

3757. $\int_1^{+\infty} x^a e^{-x} dx \quad (a \leq a \leq b).$

解 当 $a \leq a \leq b$ 且 $x \geq 1$ 时,

$$0 < x^a e^{-x} \leq x^b e^{-x}.$$

由于

$$\lim_{x \rightarrow +\infty} x^2 \cdot x^b e^{-x} = \lim_{x \rightarrow +\infty} \frac{x^{b+2}}{e^x} = 0,$$

故积分 $\int_1^{+\infty} x^b e^{-x} dx$ 收敛. 从而积分

$$\int_1^{+\infty} x^a e^{-x} dx$$

在区间 $a \leq a \leq b$ 上一致收敛.

3758. $\int_{-\infty}^{+\infty} \frac{\cos \alpha x}{1+x^2} dx \quad (-\infty < \alpha < +\infty).$

解 由于 $\left| \frac{\cos \alpha x}{1+x^2} \right| \leq \frac{1}{1+x^2}$, 且积分 $\int_{-\infty}^{+\infty} \frac{dx}{1+x^2} = \pi$ 收敛, 故积分

$$\int_{-\infty}^{+\infty} \frac{\cos \alpha x}{1+x^2} dx$$

在 $-\infty < \alpha < +\infty$ 上一致收敛.

3759. $\int_0^{+\infty} \frac{dx}{(x+\alpha)^2+1} \quad (0 \leq \alpha < +\infty).$

解 由于 $0 < \frac{1}{(x+\alpha)^2+1} \leq \frac{1}{1+x^2} \quad (0 \leq \alpha < +\infty),$

且积分 $\int_0^{+\infty} \frac{dx}{1+x^2} = \frac{\pi}{2}$ 收敛, 故积分

$$\int_0^{+\infty} \frac{dx}{(x+\alpha)^2+1}$$

在 $0 \leq \alpha < +\infty$ 上一致收敛.

$$3760. \int_0^{+\infty} \frac{\sin x}{x} e^{-ax} dx \quad (0 \leq a < +\infty).$$

解 首先注意, 因为

$$\lim_{x \rightarrow +0} \frac{\sin x}{x} e^{-ax} = 1,$$

故 $x=0$ 不是瑕点.

证法一

由于 $\left| \int_0^A \sin x dx \right| = |1 - \cos A| \leq 2$, 而当 $0 \leq a < +\infty$ 时, 函数 $\frac{e^{-ax}}{x}$ 在 $x > 0$ 关于 x 递减, 并且当 $x \rightarrow +\infty$ 时它关于 a ($0 \leq a < +\infty$) 一致趋于零 (因为 $0 \leq a < +\infty$, $x > 0$ 时, $0 < \frac{e^{-ax}}{x} \leq \frac{1}{x}$), 故由

迪里黑里判别法知积分 $\int_0^{+\infty} \frac{\sin x}{x} e^{-ax} dx$ 在 $0 \leq a < +\infty$ 上一致收敛.

证法二

由积分学第二中值定理知: 当 $A' > A > 0$ 时,

$$\left| \int_A^{A'} \frac{\sin x}{x} e^{-ax} dx \right| = \left| \frac{1}{A} \int_A^{\xi} e^{-ax} \sin x dx \right|,$$

其中 $A \leq \xi \leq A'$. 我们知道 $e^{-ax} \sin x$ 的原函数是

$$F_a(x) = -\frac{\alpha \sin x + \cos x}{1 + \alpha^2} e^{-ax},$$

显然, 当 $\alpha \geq 0$, $x > 0$ 时,

$$|F_a(x)| \leq \frac{a+1}{1+a^2} \leq \frac{2a}{1+a^2} + \frac{1}{1+a^2} < 2,$$

故当 $A' > A > 0$, $0 \leq a < +\infty$ 时,

$$\begin{aligned} & \left| \int_A^{A'} \frac{\sin x}{x} e^{-ax} dx \right| \\ &= \left| \frac{1}{A} (F_a(\xi) - F_a(A)) \right| < \frac{4}{A}. \end{aligned}$$

由此, 利用一致收敛的哥西收敛准则, 即知积分

$$\int_0^{+\infty} \frac{\sin x}{x} e^{-ax} dx$$

在 $0 \leq a < +\infty$ 上一致收敛. 证毕.

3761. $\int_1^{+\infty} e^{-ax} \frac{\cos x}{x^p} dx$ ($0 \leq a < +\infty$), 其中 $p > 0$ 是常数.

解 由于

$$\left| \int_1^A \cos x dx \right| = |\sin A - \sin 1| \leq 2,$$

而当 $0 \leq a < +\infty$ 时, 函数 $\frac{e^{-ax}}{x^p}$ 在 $x \geq 1$ 关于 x 递减且当 $x \rightarrow +\infty$ 时关于 a ($0 \leq a < +\infty$) 一致趋于零 (因为 $0 \leq a < +\infty$, $x \geq 1$ 时, $0 < \frac{e^{-ax}}{x^p} \leq \frac{1}{x^p}$),

故由迪里黑里判别法即知 $\int_1^{+\infty} e^{-ax} \frac{\cos x}{x^p} dx$ 在 $0 \leq a < +\infty$ 上一致收敛.

注意, 也可仿3760题证法二, 利用积分学第二中

值定理来证明。

$$3762. \int_0^{+\infty} \sqrt{a} e^{-ax^2} dx \quad (0 \leq a < +\infty).$$

解 此积分是收敛的。事实上，当 $a=0$ 时，积分为零；当 $a>0$ 时，设 $\sqrt{a}x=t$ ，则得

$$\int_0^{+\infty} \sqrt{a} e^{-ax^2} dx = \int_0^{+\infty} e^{-t^2} dt = \frac{\sqrt{\pi}}{2}.$$

但是，此积分却不一致收敛。事实上，对于任何的 $A>0$ ，由于

$$\begin{aligned} \lim_{a \rightarrow +0} \int_A^{+\infty} \sqrt{a} e^{-ax^2} dx &= \lim_{a \rightarrow +0} \int_{\sqrt{a}A}^{+\infty} e^{-t^2} dt \\ &= \int_0^{+\infty} e^{-t^2} dt = \frac{\sqrt{\pi}}{2}, \end{aligned}$$

故对于 $0 < \varepsilon_0 < \frac{\sqrt{\pi}}{2}$ ，必存在 $a_0 > 0$ ，使有

$$\int_A^{+\infty} \sqrt{a_0} e^{-a_0 x^2} dx > \varepsilon_0,$$

即此积分不是一致收敛的。

$$3763. \int_{-\infty}^{+\infty} e^{-(x-a)^2} dx, \quad (a) \ a < a < b;$$

$$(b) \ -\infty < a < +\infty.$$

解 显然，对任何固定的 a ，积分 $\int_{-\infty}^{+\infty} e^{-(x-a)^2} dx$ 都收敛，并且（作代换 $x-a=t$ ）

$$\int_{-\infty}^{+\infty} e^{-(x-a)^2} dx = \int_{-\infty}^{+\infty} e^{-t^2} dt = \sqrt{\pi}.$$

(a) 取正数 R 充分大, 使 $-R < a < b < R$. 显然, 当 $|x| \geq R$ 时, 对一切 $a < \alpha < b$, 有

$$0 < e^{-(x-a)^2} < e^{-(|x|-R)^2},$$

显然积分 $\int_{-\infty}^{+\infty} e^{-(|x|-R)^2} dx = 2 \int_0^{+\infty} e^{-(x-R)^2} dx$

收敛, 故积分 $\int_{-\infty}^{+\infty} e^{-(x-a)^2} dx$ 对 $a < \alpha < b$ 一致收敛.

(6) 对任何 $A > 0$, 有

$$\begin{aligned} & \lim_{a \rightarrow +\infty} \int_A^{+\infty} e^{-(x-a)^2} dx \\ &= \lim_{a \rightarrow +\infty} \int_{A-a}^{+\infty} e^{-t^2} dt = \int_{-\infty}^{+\infty} e^{-t^2} dt = \sqrt{\pi}, \end{aligned}$$

故当 a 充分大时, $\int_A^{+\infty} e^{-(x-a)^2} dx > \frac{\sqrt{\pi}}{2}$; 由此

可知 $\int_0^{+\infty} e^{-(x-a)^2} dx$ 在 $-\infty < a < +\infty$ 上非一致收

敛, 当然 $\int_{-\infty}^{+\infty} e^{-(x-a)^2} dx$ 在 $-\infty < a < +\infty$ 上更非一致收敛.

3764. $\int_0^{+\infty} e^{-x^2(1+y^2)} \sin x dy \quad (-\infty < x < +\infty).$

解 此积分对任一固定的 x 值, 显然是收敛的, 且当 $x > 0$ 时,

$$\int_0^{+\infty} e^{-x^2(1+y^2)} \sin x dy = \frac{\sin x}{x} e^{-x^2} \cdot \frac{\sqrt{\pi}}{2}.$$

但是, 它对 $-\infty < x < +\infty$ 却不是一致收敛的, 事实上, 对于任何的 $A > 0$, 当 $x > 0$ 时,

$$\begin{aligned} & \int_A^{+\infty} e^{-x^2(1+y^2)} \sin x \, dy \\ &= \frac{\sin x}{x} e^{-x^2} \cdot \int_{Ax}^{+\infty} e^{-t^2} \, dt \rightarrow \int_0^{+\infty} e^{-t^2} \, dt \\ &= \frac{\sqrt{\pi}}{2} \quad (x \rightarrow +0), \end{aligned}$$

由此可知积分不一致收敛.

3765. $\int_0^{+\infty} \frac{\sin(x^2)}{1+x^p} dx \quad (p \geq 0)$.

解 由2380题易知积分

$$\int_0^{+\infty} \sin(x^2) dx$$

收敛, 又 $\frac{1}{1+x^p}$ ($p \geq 0$) 在 $x \geq 0$ 上对 x 单调递减且一致有界:

$$0 < \frac{1}{1+x^p} \leq 1 \quad (p \geq 0, x \geq 0),$$

故由亚伯耳判别法知积分

$$\int_0^{+\infty} \frac{\sin(x^2)}{1+x^p} dx$$

对 $p \geq 0$ 一致收敛.

3766. $\int_0^1 x^{p-1} \ln^q \frac{1}{x} dx$, (a) $p \geq p_0 > 0$;

(6) $p > 0$ ($q > -1$).

解 首先注意, $x = 0$ 和 $x = 1$ 都可能是瑕点. 作代换 $x = e^{-t}$, 得

$$\begin{aligned} \int_0^1 x^{p-1} \ln^q \frac{1}{x} dx &= - \int_{+\infty}^0 e^{-(p-1)t^q} e^{-t} dt \\ &= \int_0^{+\infty} e^{-pt^q} dt, \end{aligned}$$

右端的积分当 $p > 0$ ($q > -1$) 时是收敛的^{*}, 从而左端的积分此时也收敛. 更由于 ($\varepsilon, \varepsilon' > 0$ 很小)

$$\int_{\varepsilon}^{1-\varepsilon'} x^{p-1} \ln^q \frac{1}{x} dx = \int_{\ln \frac{1}{1-\varepsilon'}}^{\ln \frac{1}{\varepsilon}} e^{-pt^q} dt,$$

故 $\int_0^1 x^{p-1} \ln^q \frac{1}{x} dx$ 的一致收敛性等价于 $\int_0^{+\infty} e^{-pt^q} dt$ 的一致收敛性.

(a) 当 $p \geq p_0 > 0$ 时, 由于

$$0 < e^{-pt^q} \leq e^{-p_0 t^q} \quad (0 < t < +\infty),$$

而积分 $\int_0^{+\infty} e^{-p_0 t^q} dt$ 收敛, 故积分 $\int_0^{+\infty} e^{-pt^q} dt$ 一致收敛 (对于 $p \geq p_0 > 0$). 从而原积分 $\int_0^1 x^{p-1} \ln^q \frac{1}{x} dx$ 当 $p \geq p_0 > 0$ 时一致收敛.

(6) 对任何 $A > 0, p > 0$, 作代换 $pt = s$, 则

$$\int_A^{+\infty} e^{-pt^q} dt = \frac{1}{p^{q+1}} \int_{pA}^{+\infty} s^q e^{-s} ds,$$

由于 $q > -1$, 故积分 $\int_0^{+\infty} s^q e^{-s} ds$ 收敛, 且显然

$$0 < \int_0^{+\infty} s^2 e^{-s} ds < +\infty,$$

于是, 有

$$\lim_{p \rightarrow 0} \int_A^{+\infty} e^{-pt^2} dt = +\infty,$$

由此即知积分 $\int_0^{+\infty} e^{-pt^2} dt$ 在 $p > 0$ 上非一致收敛.

从而原积分 $\int_0^1 x^{p-1} \ln^2 \frac{1}{x} dx$ 当 $p > 0$ 时非一致收敛.

*) 利用2361题的结果 (在其中作代换 $pt=s$).

$$3767. \int_0^1 \frac{x^n}{\sqrt{1-x^2}} dx \quad (0 \leq n < +\infty).$$

解 注意, $x=1$ 是瑕点. 由于当 $0 \leq x < 1$ 时, 有

$$0 \leq \frac{x^n}{\sqrt{1-x^2}} < \frac{1}{\sqrt{1-x^2}} \quad (0 \leq n < +\infty),$$

而积分 $\int_0^1 \frac{dx}{\sqrt{1-x^2}} = \arcsin x \Big|_0^1 = \frac{\pi}{2}$ 收敛, 故由

外氏判别法知积分 $\int_0^1 \frac{x^n}{\sqrt{1-x^2}} dx$ 当 $0 \leq n < +\infty$ 时一致收敛.

$$3768. \int_0^1 \sin \frac{1}{x} \cdot \frac{dx}{x^n} \quad (0 < n < 2).$$

解 作代换 $\frac{1}{x} = t$, 则

$$\int_0^1 \sin \frac{1}{x} \cdot \frac{dx}{x^n} = \int_1^{+\infty} t^{n-2} \sin t dt,$$

并且, 很明显, $\int_0^1 \sin \frac{1}{x} \cdot \frac{dx}{x^n}$ 的一致收敛相当于

$\int_1^{+\infty} t^{n-2} \sin t dt$ 的一致收敛. 显然, 当 $n < 2$ 时, 积分

$\int_1^{+\infty} t^{n-2} \sin t dt$ 是收敛的. 下证: 当 $0 < n < 2$ 时,

它不一致收敛. 事实上, 当 $0 < n < 2$ 时, 对任何正整数 m , 有

$$\begin{aligned} \int_{2m\pi + \frac{\pi}{4}}^{2m\pi + \frac{3\pi}{4}} t^{n-2} \sin t dt &> \frac{\sqrt{2}}{2} \int_{2m\pi + \frac{\pi}{4}}^{2m\pi + \frac{3\pi}{4}} \frac{dt}{t^{2-n}} \\ &> \frac{\sqrt{2}}{2} \cdot \frac{\pi}{4} \cdot \frac{1}{\left(2m\pi + \frac{\pi}{2}\right)^{2-n}}. \end{aligned}$$

由于 $\lim_{m \rightarrow +\infty} \frac{1}{\left(2m\pi + \frac{\pi}{2}\right)^{2-n}} = 1$, 故当 n 在 $0 < n < 2$

内且与 2 充分接近时, 必有 $\frac{1}{\left(2m\pi + \frac{\pi}{2}\right)^{2-n}} > \frac{1}{2}$. 于

是, 这时

$$\int_{2m\pi + \frac{\pi}{4}}^{2m\pi + \frac{3\pi}{4}} t^{n-2} \sin t dt > \frac{\sqrt{2}\pi}{16} = \text{常数} > 0,$$

故 $\int_1^{+\infty} t^{n-2} \sin t dt$ 在 $0 < n < 2$ 上非一致收敛.

$$3769. \int_0^2 \frac{x^\alpha dx}{\sqrt[3]{(x-1)(x-2)^2}} \quad \left(|\alpha| < \frac{1}{2}\right).$$

解 首先注意 $x=1$, $x=2$ 是瑕点; $x=0$ 可能是瑕点. 将积分分成在 $(0, 1)$ 及 $(1, 2)$ 上的两个积分.

当 $0 < x < 1$ 且 $|\alpha| < \frac{1}{2}$ 时,

$$\left| \frac{x^\alpha}{\sqrt[3]{(x-1)(x-2)^2}} \right| < \frac{1}{x^{\frac{1}{2}}(1-x)^{\frac{1}{2}}(x-2)^{\frac{2}{3}}},$$

当 $1 < x < 2$ 且 $|\alpha| < \frac{1}{2}$ 时,

$$\left| \frac{x^\alpha}{\sqrt[3]{(x-1)(x-2)^2}} \right| < \frac{\sqrt{2}}{(x-1)^{\frac{1}{2}}(x-2)^{\frac{2}{3}}}.$$

易知上述两个不等式右端的函数分别在区间 $(0, 1)$ 及 $(1, 2)$ 上的积分收敛, 故由外氏判别法知积分

$$\int_0^2 \frac{x^\alpha}{\sqrt[3]{(x-1)(x-2)^2}} dx$$

对 $|\alpha| < \frac{1}{2}$ 一致收敛.

$$3770. \int_0^1 \frac{\sin ax}{\sqrt{|x-a|}} dx \quad (0 \leq a \leq 1).$$

$$\begin{aligned} \text{解} \quad & \int_0^1 \frac{\sin ax}{\sqrt{|x-a|}} dx \\ &= \int_0^a \frac{\sin ax}{\sqrt{a-x}} dx + \int_a^1 \frac{\sin ax}{\sqrt{x-a}} dx. \end{aligned}$$

对于积分 $\int_0^a \frac{\sin \alpha x}{\sqrt{\alpha-x}} dx$, 由于

$$\begin{aligned} \left| \int_{a-\eta}^a \frac{\sin \alpha x}{\sqrt{\alpha-x}} dx \right| &\leq \int_{a-\eta}^a \frac{dx}{\sqrt{\alpha-x}} \\ &= 2\sqrt{\eta}, \end{aligned}$$

故对于任给的 $\varepsilon > 0$, 只要取 $0 < \eta < \frac{\varepsilon^2}{4}$, 即有

$$\left| \int_{a-\eta}^a \frac{\sin \alpha x}{\sqrt{\alpha-x}} dx \right| < \varepsilon.$$

因此, 对 $0 \leq \alpha \leq 1$ 它是一致收敛的.

对于积分 $\int_a^1 \frac{\sin \alpha x}{\sqrt{x-\alpha}} dx$, 由于

$$\begin{aligned} \left| \int_a^{a+\eta} \frac{\sin \alpha x}{\sqrt{x-\alpha}} dx \right| &\leq \int_a^{a+\eta} \frac{dx}{\sqrt{x-\alpha}} \\ &= 2\sqrt{\eta}, \end{aligned}$$

故对于任给的 $\varepsilon > 0$, 只要取 $0 < \eta < \frac{\varepsilon^2}{4}$, 即有

$$\left| \int_a^{a+\eta} \frac{\sin \alpha x}{\sqrt{x-\alpha}} dx \right| < \varepsilon.$$

因此, 对 $0 \leq \alpha \leq 1$ 它是一致收敛的.

于是, 积分

$$\int_0^1 \frac{\sin \alpha x}{\sqrt{|x-\alpha|}} dx$$

对 $0 \leq \alpha \leq 1$ 一致收敛.

3771. 若积分在参数的已知值的某邻域内一致收敛, 则称此积分对参数的已知值一致收敛. 证明积分

$$I = \int_0^{+\infty} \frac{\alpha dx}{1 + \alpha^2 x^2}$$

在每一个 $\alpha \neq 0$ 的值一致收敛, 而在 $\alpha = 0$ 非一致收敛.

证 设 α_0 为任一不为零的数, 不妨设 $\alpha_0 > 0$. 今取 $\delta > 0$, 使 $\alpha_0 - \delta > 0$. 下面证明积分 I 在 $(\alpha_0 - \delta, \alpha_0 + \delta)$ 内一致收敛. 事实上, 当 $\alpha \in (\alpha_0 - \delta, \alpha_0 + \delta)$ 时, 由于

$$0 < \frac{\alpha}{1 + \alpha^2 x^2} < \frac{\alpha_0 + \delta}{1 + (\alpha_0 - \delta)^2 x^2},$$

且积分

$$\int_0^{+\infty} \frac{\alpha_0 + \delta}{1 + (\alpha_0 - \delta)^2 x^2} dx$$

收敛, 故由外氏判别法知积分

$$\int_0^{+\infty} \frac{\alpha dx}{1 + \alpha^2 x^2}$$

在 $(\alpha_0 - \delta, \alpha_0 + \delta)$ 内一致收敛, 从而在 α_0 点一致收敛. 由 α_0 的任意性知积分 I 在每一个 $\alpha \neq 0$ 的值一致收敛.

其次, 我们证明积分 I 在 $\alpha = 0$ 非一致收敛. 事实上, 对原点的任何邻域 $(-\delta, \delta)$ 均有下述结果: 对任何的 $A > 0$, 有

$$\int_A^{+\infty} \frac{\alpha dx}{1+\alpha^2 x^2} = \int_{\alpha A}^{+\infty} \frac{dt}{1+t^2} \quad (\alpha > 0).$$

由于

$$\lim_{\alpha \rightarrow +0} \int_{\alpha A}^{+\infty} \frac{dt}{1+t^2} = \int_0^{+\infty} \frac{dt}{1+t^2} = \frac{\pi}{2},$$

故取 $0 < \varepsilon_0 < \frac{\pi}{2}$, 在 $(-\delta, \delta)$ 中必存在某一个 $\alpha_0 > 0$, 使有

$$\left| \int_{\alpha_0 A}^{+\infty} \frac{dt}{1+t^2} \right| > \varepsilon_0,$$

即

$$\left| \int_A^{+\infty} \frac{\alpha_0 dx}{1+\alpha_0^2 x^2} \right| > \varepsilon_0.$$

因此, 积分 I 在 $\alpha = 0$ 点的任一邻域 $(-\delta, \delta)$ 内非一致收敛, 从而积分 I 在 $\alpha = 0$ 时非一致收敛.

3772. 在下式中

$$\lim_{\alpha \rightarrow +0} \int_0^{+\infty} \alpha e^{-\alpha x} dx$$

把极限移到积分符号内合理吗?

解 不合理. 事实上, 由3754题2)的结果知, 积分

$$\int_0^{+\infty} \alpha e^{-\alpha x} dx \text{ 对 } 0 \leq \alpha \leq b \quad (b > 0) \text{ 的收敛并非一致,}$$

故一般不能应用积分符号与极限符号的交换定理. 对于本题, 实际上也不能交换, 这是由于

$$\int_0^{+\infty} \left(\lim_{a \rightarrow +0} a e^{-ax} \right) dx = 0,$$

而

$$\lim_{a \rightarrow +0} \int_0^{+\infty} a e^{-ax} dx = \lim_{a \rightarrow +0} \left(-e^{-ax} \right) \Big|_0^{+\infty} = 1,$$

故得

$$\lim_{a \rightarrow +0} \int_0^{+\infty} a e^{-ax} dx \neq \int_0^{+\infty} \left(\lim_{a \rightarrow +0} a e^{-ax} \right) dx.$$

3773. 函数 $f(x)$ 在区间 $(0, +\infty)$ 内可积分, 证明公式

$$\lim_{a \rightarrow +0} \int_0^{+\infty} e^{-ax} f(x) dx = \int_0^{+\infty} f(x) dx.$$

证 容许有有限个瑕点. 为叙述简单起见, 例如, 设只有一个瑕点 $x=0$. 已知积分 $\int_0^{+\infty} f(x) dx$ 收敛且被积函数中不含有 a , 故它关于 a 一致收敛. 又因函数 e^{-ax} 对于固定的 $0 \leq a \leq 1$, 关于 x ($x > 0$) 是递减的, 并且一致有界: $0 < e^{-ax} \leq 1$ ($0 \leq a \leq 1, x > 0$), 故根据亚贝尔判别法知积分 $\int_0^{+\infty} e^{-ax} f(x) dx$ 在 $0 \leq a \leq 1$ 上一致收敛. 于是, 对于任给的 $\varepsilon > 0$, 可取 $\eta > 0$, $A_0 > 0$ ($\eta < A_0$), 使

$$\left| \int_0^\eta e^{-ax} f(x) dx \right| < \frac{\varepsilon}{5},$$

$$\left| \int_{A_0}^{+\infty} e^{-ax} f(x) dx \right| < \frac{\varepsilon}{5} \quad (0 \leq a \leq 1).$$

由于 $f(x)$ 在 $(\eta, A_0]$ 上常义可积, 故有界, 即存在常数

M_0 , 使 $|f(x)| \leq M_0$ ($\eta \leq x \leq A_0$)。再根据二元函数 e^{-ax} 在 $0 \leq a \leq 1$, $\eta \leq x \leq A_0$ 上的一致连续性知, 必存在 $\delta > 0$ ($\delta < 1$), 使当 $0 < a < \delta$ 时, 对一切 $\eta \leq x \leq A_0$, 皆有

$$0 \leq 1 - e^{-ax} < \frac{\varepsilon}{5 A_0 M_0}.$$

于是, 当 $0 < a < \delta$ 时, 恒有

$$\begin{aligned} & \left| \int_0^{+\infty} e^{-ax} f(x) dx - \int_0^{+\infty} f(x) dx \right| \\ &= \left| \int_{\eta}^{A_0} (e^{-ax} - 1) f(x) dx + \int_{A_0}^{+\infty} e^{-ax} f(x) dx \right. \\ & \quad \left. - \int_{A_0}^{+\infty} f(x) dx + \int_0^{\eta} e^{-ax} f(x) dx - \int_0^{\eta} f(x) dx \right| \\ & < M_0 A_0 \cdot \frac{\varepsilon}{5 A_0 M_0} + \frac{\varepsilon}{5} + \frac{\varepsilon}{5} + \frac{\varepsilon}{5} + \frac{\varepsilon}{5} = \varepsilon. \end{aligned}$$

由此可知

$$\lim_{a \rightarrow +0} \int_0^{+\infty} e^{-ax} f(x) dx = \int_0^{+\infty} f(x) dx.$$

3774. 若 $f(x)$ 在区间 $(0, +\infty)$ 内绝对可积分, 证明

$$\lim_{n \rightarrow \infty} \int_0^{+\infty} f(x) \sin nx dx = 0.$$

证 由 $f(x)$ 在区间 $(0, +\infty)$ 内的绝对可积性可知: 对于任给的 $\varepsilon > 0$, 存在 $A > 0$, 使有

$$\int_A^{+\infty} |f(x)| dx < \frac{\varepsilon}{3}.$$

于是,

$$\begin{aligned} & \left| \int_0^{+\infty} f(x) \sin nx \, dx \right| \\ & \leq \left| \int_0^A f(x) \sin nx \, dx \right| + \frac{\varepsilon}{3}. \end{aligned}$$

先设 $f(x)$ 在 $[0, A)$ 中无瑕点. 我们在 $[0, A)$ 中插入分点 $0 = t_0 < t_1 < t_2 < \dots < t_{m-1} < t_m = A$, 并设 $f(x)$ 在 (t_{k-1}, t_k) 上的下确界为 m_k , 则有

$$\begin{aligned} \int_0^A f(x) \sin nx \, dx &= \sum_{k=1}^m \int_{t_{k-1}}^{t_k} f(x) \sin nx \, dx \\ &= \sum_{k=1}^m \int_{t_{k-1}}^{t_k} [f(x) - m_k] \sin nx \, dx \\ &\quad + \sum_{k=1}^m m_k \int_{t_{k-1}}^{t_k} \sin nx \, dx, \end{aligned}$$

从而有

$$\begin{aligned} & \left| \int_0^A f(x) \sin nx \, dx \right| \\ & \leq \sum_{k=1}^m w_k \Delta t_k + \sum_{k=1}^m |m_k| \cdot \frac{|\cos nt_{k-1} - \cos nt_k|}{n} \\ & \leq \sum_{k=1}^m w_k \Delta t_k + \frac{2}{n} \sum_{k=1}^m |m_k|, \end{aligned}$$

其中 w_k 为 $f(x)$ 在区间 (t_{k-1}, t_k) 上的振幅, $\Delta t_k = t_k - t_{k-1}$.

由于 $f(x)$ 在 $[0, A)$ 上可积, 故可取某一分法, 使有

$$\left| \sum_{k=1}^n w_k \Delta t_k \right| < \frac{\varepsilon}{3}.$$

对于这样固定的分法, $\sum_{k=1}^m |m_k|$ 为一定值, 因而存在 N , 使当 $n > N$ 时, 恒有

$$\frac{2}{n} \sum_{k=1}^m |m_k| < \frac{\varepsilon}{3}.$$

于是, 对于上述所选取的 N , 当 $n > N$ 时,

$$\begin{aligned} & \left| \int_0^{+\infty} f(x) \sin nx \, dx \right| \\ & \leq \left| \int_0^A f(x) \sin nx \, dx \right| + \left| \int_A^{+\infty} f(x) \sin nx \, dx \right| \\ & \leq \sum_{k=1}^n w_k \Delta t_k + \frac{2}{n} \sum_{k=1}^m |m_k| + \int_A^{+\infty} |f(x)| \, dx \\ & < \frac{\varepsilon}{3} + \frac{\varepsilon}{3} + \frac{\varepsilon}{3} = \varepsilon, \end{aligned}$$

即

$$\lim_{n \rightarrow \infty} \int_0^{+\infty} f(x) \sin nx \, dx = 0.$$

其次, 设 $f(x)$ 在区间 $(0, A)$ 中有瑕点. 为简便起见, 不妨设只有一个瑕点, 且为 0 . 于是, 对于任给的 $\varepsilon > 0$, 存在 $\eta > 0$, 使有

$$\int_0^\eta |f(x)| \, dx < \frac{\varepsilon}{3}.$$

但是, $f(x)$ 在 $[\eta, A]$ 上无瑕点, 故应用上述结果可知存在 N , 使当 $n > N$ 时, 恒有

$$\left| \int_{\eta}^A f(x) \sin nx \, dx \right| < \frac{\varepsilon}{3}.$$

于是, 当 $n > N$ 时, 有

$$\begin{aligned} & \left| \int_0^{+\infty} f(x) \sin nx \, dx \right| \\ & \leq \int_0^{\eta} |f(x)| \, dx + \left| \int_{\eta}^A f(x) \sin nx \, dx \right| \\ & \quad + \int_A^{+\infty} |f(x)| \, dx \\ & < \frac{\varepsilon}{3} + \frac{\varepsilon}{3} + \frac{\varepsilon}{3} = \varepsilon. \end{aligned}$$

即

$$\lim_{n \rightarrow \infty} \int_0^{+\infty} f(x) \sin nx \, dx = 0.$$

总之, 当 $f(x)$ 在 $(0, +\infty)$ 内绝对可积, 不论 $f(x)$ 在 $(0, +\infty)$ 内有无瑕点, 均可证得

$$\lim_{n \rightarrow \infty} \int_0^{+\infty} f(x) \sin nx \, dx = 0.$$

3775. 证明: 若 (1) 在每一个有穷区间 (a, b) 内 $f(x, y) \rightarrow f(x, y_0)$; (2) $|f(x, y)| \leq F(x)$, 其中

$$\int_a^{+\infty} F(x) \, dx < +\infty, \text{ 则}$$

$$\lim_{y \rightarrow y_0} \int_a^{+\infty} f(x, y) dx = \int_a^{+\infty} \lim_{y \rightarrow y_0} f(x, y) dx.$$

证 条件(1)表示当 $y \rightarrow y_0$ 时, 当 x 在任何有穷区间 (a, b) 上, $f(x, y)$ 都一致趋于 $f(x, y_0)$. 于是, 有

$$\lim_{y \rightarrow y_0} \int_a^b f(x, y) dx = \int_a^b f(x, y_0) dx$$

(对任何 $b > a$).

又在不等式 $|f(x, y)| \leq F(x)$ 中令 $y \rightarrow y_0$ (任意固定 x), 得 $|f(x, y_0)| \leq F(x)$, 故 $\int_a^{+\infty} f(x, y_0) dx$ 收敛.

任给 $\varepsilon > 0$. 由于 $\int_a^{+\infty} F(x) dx < +\infty$, 故可取定某 $b > a$, 使 $\int_b^{+\infty} F(x) dx < \frac{\varepsilon}{3}$. 对此 b , 又可取 $\delta > 0$, 使当 $0 < |y - y_0| < \delta$ 时, 恒有

$$\left| \int_a^b f(x, y) dx - \int_a^b f(x, y_0) dx \right| < \frac{\varepsilon}{3}.$$

于是, 当 $0 < |y - y_0| < \delta$ 时, 恒有

$$\begin{aligned} & \left| \int_a^{+\infty} f(x, y) dx - \int_a^{+\infty} f(x, y_0) dx \right| \\ & \leq \left| \int_a^b f(x, y) dx - \int_a^b f(x, y_0) dx \right| \\ & \quad + \int_b^{+\infty} |f(x, y)| dx + \int_b^{+\infty} |f(x, y_0)| dx \end{aligned}$$

$$\begin{aligned}
&< \frac{\varepsilon}{3} + \int_0^{+\infty} F(x) dx + \int_t^{+\infty} F(x) dx \\
&< \frac{\varepsilon}{3} + \frac{\varepsilon}{3} + \frac{\varepsilon}{3} = \varepsilon.
\end{aligned}$$

由此可知

$$\begin{aligned}
&\lim_{y \rightarrow y_0} \int_a^{+\infty} f(x, y) dx \\
&= \int_a^{+\infty} f(x, y_0) dx = \int_a^{+\infty} \lim_{y \rightarrow y_0} f(x, y) dx.
\end{aligned}$$

证毕.

注. 本题中应假定: 对任何 $b > a$, $f(x, y)$ 关于 x 在 $[a, b)$ 上可积.

3776. 利用积分符号与极限号互换, 计算积分

$$\int_0^{+\infty} e^{-x^2} dx = \int_0^{+\infty} \lim_{n \rightarrow \infty} \left[\left(1 + \frac{x^2}{n} \right)^{-n} \right] dx.$$

解 先证积分符号与极限号能互换. 事实上, (1) 函数 $\left(1 + \frac{x^2}{n} \right)^{-n}$ 在 $0 \leq x \leq A$ 上连续 (任何 $A > 0$),

故它在 $(0, A)$ 上可积; (2) 又 $\left(1 + \frac{x^2}{n} \right)^{-n}$ 在 $(0, A)$ 上关于 n 为单调减小的, 且

$$\lim_{n \rightarrow \infty} \left(1 + \frac{x^2}{n} \right)^{-n} = e^{-x^2}$$

为连续函数, 故按狄尼定理, 当 $n \rightarrow \infty$ 时, 函数

$(1 + \frac{x^2}{n})^{-n}$ 在 $[0, A]$ 上一致趋向于 e^{-x^2} ; (3) 由

于 $0 < (1 + \frac{x^2}{n})^{-n} \leq \frac{1}{1+x^2}$ ($n = 1, 2, \dots$), 且

$$\int_0^{+\infty} \frac{dx}{1+x^2} = \frac{\pi}{2} < +\infty, \text{ 故积分 } \int_0^{+\infty} (1 + \frac{x^2}{n})^{-n} dx$$

关于 n 一致收敛. 因此, 我们可以应用积分符号与极限号的互换定理*), 从而得

$$\int_0^{+\infty} e^{-x^2} dx = \lim_{n \rightarrow \infty} \int_0^{+\infty} \frac{dx}{(1 + \frac{x^2}{n})^n}.$$

而

$$\begin{aligned} \int_0^{+\infty} \frac{dx}{(1 + \frac{x^2}{n})^n} &= \sqrt{n} \int_0^{+\infty} \frac{dt}{(1+t^2)^n} \\ &= \sqrt{n} I_n, \end{aligned}$$

又由于

$$\begin{aligned} I_{n-1} &= \int_0^{+\infty} \frac{dt}{(1+t^2)^{n-1}} \\ &= \frac{t}{(1+t^2)^{n-1}} \Big|_0^{+\infty} + 2(n-1) \int_0^{+\infty} \frac{t^2}{(1+t^2)^n} dt \\ &= 2(n-1)I_{n-1} - 2(n-1)I_n, \end{aligned}$$

故得

$$I_n = \frac{2n-3}{2n-2} I_{n-1}.$$

又因 $I_1 = \int_0^{+\infty} \frac{dt}{1+t^2} = \frac{\pi}{2}$, 将上式递推即得

$$I_n = \frac{1 \cdot 3 \cdots (2n-3)}{2 \cdot 4 \cdots (2n-2)} \cdot \frac{\pi}{2} = \frac{(2n-3)!!}{(2n-2)!!} \cdot \frac{\pi}{2}.$$

于是,

$$\int_0^{+\infty} e^{-x^2} dx = \lim_{n \rightarrow \infty} \frac{(2n-3)!!}{(2n-2)!!} \cdot \frac{\pi \sqrt{n}}{2}.$$

根据瓦里斯公式, 我们有

$$\begin{aligned} \frac{\pi}{2} &= \lim_{n \rightarrow \infty} \frac{[(2n)!!]^2}{(2n+1)[(2n-1)!!]^2} \\ &= \lim_{n \rightarrow \infty} \frac{[(2n-2)!!]^2}{(2n-1)[(2n-3)!!]^2}. \end{aligned}$$

最后得

$$\begin{aligned} \int_0^{+\infty} e^{-x^2} dx &= \frac{\pi}{2} \lim_{n \rightarrow \infty} \frac{(2n-3)!! \sqrt{n}}{(2n-2)!!} \\ &= \frac{\pi}{2} \lim_{n \rightarrow \infty} \frac{(2n-3)!! \sqrt{2n-1}}{(2n-2)!!} \\ &\quad \cdot \sqrt{\frac{n}{2n-1}} \\ &= \frac{\pi}{2} \cdot \sqrt{\frac{2}{\pi}} \cdot \sqrt{\frac{1}{2}} = \frac{\sqrt{\pi}}{2}. \end{aligned}$$

*) 参看菲赫金哥尔茨著《微积分学教程》第二卷 480目定理 I.

3777. 证明: 积分

$$F(a) = \int_0^{+\infty} e^{-(x-a)^2} dx$$

是参数 a 的连续函数.

$$\begin{aligned}
 \text{证 } F(a) &= \int_0^{+\infty} e^{-(x-a)^2} dx = \int_{-a}^{+\infty} e^{-x^2} dx \\
 &= \int_{-a}^0 e^{-x^2} dx + \int_0^{+\infty} e^{-x^2} dx \\
 &= \int_0^a e^{-x^2} dx + \frac{\sqrt{\pi}}{2}.
 \end{aligned}$$

由变上限积分的性质可知积分 $\int_0^a e^{-x^2} dx$ 是 a ($-\infty < a < +\infty$) 的连续函数, 故 $F(a)$ 也是 a ($-\infty < a < +\infty$) 的连续函数.

3778. 求函数

$$F(a) = \int_0^{+\infty} \frac{\sin(1-a^2)x}{x} dx$$

的不连续点. 作出函数 $y = F(a)$ 的图形.

解 当 $1 - a^2 > 0$ 即 $|a| < 1$ 时,

$$\begin{aligned}
 F(a) &= \int_0^{+\infty} \frac{\sin(1-a^2)x}{(1-a^2)x} d[(1-a^2)x] \\
 &= \int_0^{+\infty} \frac{\sin t}{t} dt = \frac{\pi}{2}.
 \end{aligned}$$

当 $1 - a^2 < 0$ 即 $|a| > 1$ 时,

$$\begin{aligned}
 F(a) &= - \int_0^{+\infty} \frac{\sin(a^2-1)x}{(a^2-1)x} d[(a^2-1)x] \\
 &= - \int_0^{+\infty} \frac{\sin t}{t} dt = -\frac{\pi}{2}.
 \end{aligned}$$

当 $1-a^2=0$
即 $|a|=1$ 时,

$$F(a)=0.$$

于是, $a=\pm 1$ 为
 $F(a)$ 的不连续
点. 如图 7·2
所示.



图 7·2

研究下列函数在
所指定区间内的
连续性:

3779. $F(a) = \int_0^{+\infty} \frac{x dx}{2+x^a}$ 当 $a > 2$.

解 对于积分 $\int_1^{+\infty} \frac{x dx}{2+x^a}$. 由于当 $x \geq 1$ 时,

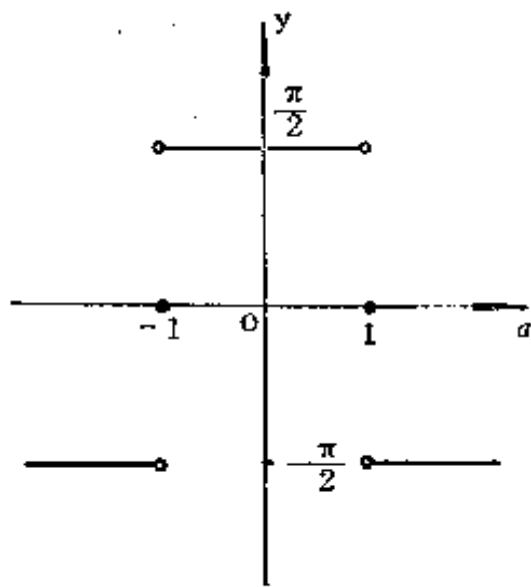
$$0 < \frac{x}{2+x^a} < \frac{x}{x^a} \leq \frac{1}{x^{\alpha_0-1}},$$

其中 $a \geq \alpha_0 > 2$, 且积分

$$\int_1^{+\infty} \frac{dx}{x^{\alpha_0-1}}$$

收敛, 故积分

$$\int_1^{+\infty} \frac{x dx}{2+x^a}$$

对 $a \geq \alpha_0$ 一致收敛, 从而积分

$$\int_0^{+\infty} \frac{x dx}{2+x^a}$$

对 $a \geq \alpha_0$ 一致收敛. 因此, $F(a)$ 当 $a \geq \alpha_0$ 时连续. 由于 $\alpha_0 > 2$ 的任意性, 故知 $F(a)$ 当 $a > 2$ 时连续.

$$3780. \quad F(a) = \int_1^{+\infty} \frac{\cos x}{x^a} dx \text{ 当 } a > 0.$$

解 对于任何 $A > 1$, 均有

$$\left| \int_1^A \cos x dx \right| \leq 2.$$

而函数 $\frac{1}{x^a}$ 在 $x \geq 1$, $a > 0$ 时关于 x 单调递减, 且由

$$0 < \frac{1}{x^a} \leq \frac{1}{x^{\alpha_0}} \quad (x \geq 1, a \geq \alpha_0 > 0)$$

知: 当 $x \rightarrow +\infty$ 时 $\frac{1}{x^a}$ 在 $a \geq \alpha_0$ 时一致趋于零. 因此, 由迪里黑里判别法知积分

$$\int_1^{+\infty} \frac{\cos x}{x^a} dx$$

对 $a \geq \alpha_0 > 0$ 一致收敛. 于是, 函数 $F(a)$ 当 $a \geq \alpha_0$ 时连续. 由于 $\alpha_0 > 0$ 的任意性, 故知 $F(a)$ 当 $a > 0$ 时连续.

$$3781. \quad F(a) = \int_0^{\pi} \frac{\sin x}{x^a (\pi-x)^a} dx \text{ 当 } 0 < a < 2.$$

$$\text{解 } F(a) = \int_0^{\frac{\pi}{2}} \frac{\sin x}{x^a (\pi-x)^a} dx$$

$$\begin{aligned}
& + \int_{\frac{\pi}{2}}^{\pi} \frac{\sin x}{x^{\alpha} (\pi-x)^{\alpha}} dx \\
& = \int_0^{\frac{\pi}{2}} \frac{\sin x}{x^{\alpha} (\pi-x)^{\alpha}} dx \\
& \quad - \int_{\frac{\pi}{2}}^0 \frac{\sin(\pi-t)}{(\pi-t)^{\alpha} t^{\alpha}} dt \\
& = 2 \int_0^{\frac{\pi}{2}} \frac{\sin x}{x^{\alpha} (\pi-x)^{\alpha}} dx.
\end{aligned}$$

由于当 $0 < \eta < 1$, $0 < \alpha_0 \leq \alpha \leq \alpha_1 < 2$ 时, 有

$$\begin{aligned}
& \int_0^{\eta} \frac{|\sin x|}{x^{\alpha} (\pi-x)^{\alpha}} dx \\
& \leq \left(\frac{2}{\pi}\right)^{\alpha} \int_0^{\eta} \frac{dx}{x^{\alpha-1}} \leq \left(\frac{2}{\pi}\right)^{\alpha_0} \int_0^{\eta} \frac{dx}{x^{\alpha_1-1}} \\
& = \left(\frac{2}{\pi}\right)^{\alpha_0} \frac{1}{2-\alpha_1} \cdot \eta^{2-\alpha_1},
\end{aligned}$$

故对于任给的 $\varepsilon > 0$, 当 $0 < \eta < \delta = \min \left\{ 1, \right.$

$\left. (2-\alpha_1) \frac{1}{2-\alpha_1} \left(\frac{\pi}{2}\right)^{\frac{\alpha_0}{2-\alpha_1}} \varepsilon^{\frac{1}{2-\alpha_1}} \right\}$ 时, 对一切 $\alpha_0 \leq$

$\alpha \leq \alpha_1$ 皆有

$$\left| \int_0^{\eta} \frac{\sin x}{x^{\alpha} (\pi-x)^{\alpha}} dx \right| \leq \int_0^{\eta} \frac{|\sin x|}{x^{\alpha} (\pi-x)^{\alpha}} dx < \varepsilon.$$

因此, 瑕积分 $\int_0^{\frac{\pi}{2}} \frac{\sin x}{x^{\alpha} (\pi-x)^{\alpha}} dx$ 当 $\alpha_0 \leq \alpha \leq \alpha_1$ 时

一致收敛. 从而 $F(\alpha)$ 在 $\alpha_0 \leq \alpha \leq \alpha_1$ 上连续. 由 $0 < \alpha_0 < \alpha_1 < 2$ 的任意性即知 $F(\alpha)$ 在 $0 < \alpha < 2$ 上连续.

$$3782. \quad F(\alpha) = \int_0^{+\infty} \frac{e^{-x}}{|\sin x|^\alpha} dx \quad \text{当 } 0 < \alpha < 1.$$

$$\begin{aligned} \text{解} \quad F(\alpha) &= \sum_{n=0}^{\infty} \int_{n\pi}^{(n+1)\pi} \frac{e^{-x}}{|\sin x|^\alpha} dx \\ &= \sum_{n=0}^{\infty} \int_0^\pi \frac{e^{-(n\pi+t)}}{\sin^\alpha t} dt. \end{aligned}$$

当 $0 < \alpha \leq \alpha_0 < 1$ 时,

$$\int_0^\pi \frac{e^{-(n\pi+t)}}{\sin^\alpha t} dt \leq e^{-n\pi} \int_0^\pi \frac{1}{\sin^{\alpha_0} t} dt.$$

显然, 积分

$$\int_0^\pi \frac{dt}{\sin^{\alpha_0} t} = 2 \int_0^{\frac{\pi}{2}} \frac{dt}{\sin^{\alpha_0} t},$$

且 $\lim_{t \rightarrow +0} t^{\alpha_0} \cdot \frac{1}{\sin^{\alpha_0} t} = 1$, 故它是收敛的. 而级数

$\sum_{n=0}^{\infty} e^{-n\pi}$ 为公比等于 $e^{-\pi} < 1$ 的几何级数, 它也收敛.

于是, 由外氏判别法知级数

$$\sum_{n=0}^{\infty} \int_0^\pi \frac{e^{-(n\pi+t)}}{\sin^{\alpha_0} t} dt.$$

对 $0 < \alpha \leq \alpha_0$ 一致收敛. 从而, 注意到被积函数是正的, 即知积分

$$\int_0^{+\infty} \frac{e^{-x}}{|\sin x|^\alpha} dx$$

对 $0 < a \leq a_0$ 一致收敛. 因此, $F(a)$ 在 $0 < a \leq a_0$ 上连续. 由 $a_0 < 1$ 的任意性知 $F(a)$ 当 $0 < a < 1$ 时连续.

$$3783. \quad F(a) = \int_0^{+\infty} a e^{-x a^2} dx \quad \text{当 } -\infty < a < +\infty.$$

解 当 $a \neq 0$ 时,

$$F(a) = -\frac{1}{a} e^{-x a^2} \Big|_0^{+\infty} = \frac{1}{a},$$

显然它是连续的.

当 $a = 0$ 时,

$$F(0) = \int_0^{+\infty} 0 \cdot e^{-0} dx = 0.$$

于是, 显见 $F(a)$ 当 $a = 0$ 时不连续.

§ 3. 广义积分中的变量代换. 广义积分号下微分法及积分法

1° 对参数的微分法 若 1) 函数 $f(x, y)$ 于域 $a \leq x < +\infty$, $y_1 < y < y_2$ 内是连续的并对参数 y 可微分;

2) $\int_a^{+\infty} f(x, y) dx$ 收敛; 3) $\int_a^{+\infty} f'_y(x, y) dx$ 于区间 (y_1, y_2) 内一致收敛, 则当 $y_1 < y < y_2$ 时

$$\frac{d}{dy} \int_a^{+\infty} f(x, y) dx = \int_a^{+\infty} f'_y(x, y) dx$$

(莱布尼兹法则).

2° 对参数积分的公式 若 1) 函数 $f(x, y)$ 当 $x \geq a$ 及 $y_1 \leq y \leq y_2$ 时是连续的; 2) $\int_a^{+\infty} f(x, y) dx$ 在有穷的区间 (y_1, y_2) 内一致收敛, 则

$$\begin{aligned} & \int_{y_1}^{y_2} dy \int_a^{+\infty} f(x, y) dx \\ &= \int_a^{+\infty} dx \int_{y_1}^{y_2} f(x, y) dy. \end{aligned} \quad (1)$$

若 $f(x, y) \geq 0$, 则公式 (1) 在假定等式 (1) 的一端有意义时, 对于无穷的区间 (y_1, y_2) 也正确.

3784. 利用公式

$$\int_0^1 x^{n-1} dx = \frac{1}{n} \quad (n > 0).$$

计算积分

$$I = \int_0^1 x^{n-1} \ln^m x dx, \text{ 其中 } m \text{ 为自然数.}$$

解 $\frac{dx^{n-1}}{dn} = x^{n-1} \ln x$ ($n > 0$ 为任意实数). 积分

$$\int_0^1 x^{n-1} \ln x dx \quad (1)$$

对于 $n \geq n_0 > 0$ 为一致收敛. 事实上, 当 $0 < x \leq 1$, $n \geq n_0 > 0$ 时,

$$|x^{n-1} \ln x| \leq -x^{n_0-1} \ln x,$$

而积分 $\int_0^1 x^{n_0-1} \ln x dx$ 显然收敛^{*}). 因此, 由外氏

判别法即知积分 (1) 对 $n \geq n_0 > 0$ 一致收敛。于是, 积分

$$\int_0^1 x^{n-1} dx$$

对参数 $n \geq n_0$ 求导数时, 积分号与导数符号可交换, 即

$$\begin{aligned} \frac{d}{dn} \int_0^1 x^{n-1} dx &= \int_0^1 \frac{dx^{n-1}}{dn} dx \\ &= \int_0^1 x^{n-1} \ln x dx. \end{aligned}$$

由 $n_0 > 0$ 的任意性知, 上式对任意 $n > 0$ 均成立。

同理对 n 逐次求导数, 也可在积分号下求导数, 即

$$\begin{aligned} \frac{d^2}{dn^2} \int_0^1 x^{n-1} dx &= \int_0^1 \frac{d}{dn} (x^{n-1} \ln x) dx \\ &= \int_0^1 x^{n-1} \ln^2 x dx, \end{aligned}$$

.....

由数学归纳法, 可得

$$\frac{d^m}{dn^m} \int_0^1 x^{n-1} dx = \int_0^1 x^{n-1} \ln^m x dx.$$

但是, $\int_0^1 x^{n-1} dx = \frac{1}{n}$ ($n > 0$), 故有

$$\frac{d^m}{dx^m} \int_0^1 x^{n-1} dx = \frac{(-1)^m m!}{n^{m+1}}.$$

从而得

$$\int_0^1 x^{m-1} \ln^n x dx = -\frac{(-1)^n n!}{m^{n+1}}.$$

*) 利用2362题的结果.

3785. 利用公式

$$\int_0^{+\infty} \frac{dx}{x^2+a} = \frac{\pi}{2\sqrt{a}} \quad (a>0),$$

计算积分

$$I = \int_0^{+\infty} \frac{dx}{(x^2+a)^{n+1}}, \text{ 其中 } n \text{ 为自然数.}$$

解 $\frac{\partial}{\partial a} \left(\frac{1}{x^2+a} \right) = -\frac{1}{(x^2+a)^2}$. 积分

$$\int_0^{+\infty} \frac{dx}{(x^2+a)^2} \quad (1)$$

对 $a \geq a_0 > 0$ 一致收敛. 事实上, 当 $x \geq 0, a \geq a_0 > 0$ 时,

$$\frac{1}{(x^2+a)^2} \leq \frac{1}{(x^2+a_0)^2},$$

而积分 $\int_0^{+\infty} \frac{dx}{(x^2+a_0)^2}$ 显然收敛. 因此, 由外氏判别法知积分 (1) 当 $a \geq a_0 > 0$ 时一致收敛. 于是, 利用莱布尼兹法则, 即得

$$\frac{d}{da} \int_0^{+\infty} \frac{dx}{x^2+a} = \int_0^{+\infty} \frac{\partial}{\partial a} \left(\frac{1}{x^2+a} \right) dx$$

$$= - \int_0^{+\infty} \frac{dx}{(x^2+a)^2}.$$

由 $a_0 > 0$ 的任意性知, 上式对一切 $a > 0$ 均成立.

同理对积分 $\int_0^{+\infty} \frac{dx}{x^2+a}$ 逐次求导数, 得

$$\frac{d^n}{da^n} \int_0^{+\infty} \frac{dx}{x^2+a} = (-1)^n n! \int_0^{+\infty} \frac{dx}{(x^2+a)^{n+1}}.$$

但是,

$$\begin{aligned} \frac{d}{da} \int_0^{+\infty} \frac{dx}{x^2+a} &= \frac{d}{da} \left(\frac{\pi}{2\sqrt{a}} \right) \\ &= -\frac{\pi}{2^2} \cdot \frac{1}{\sqrt{a^3}}, \end{aligned}$$

$$\begin{aligned} \frac{d^2}{da^2} \int_0^{+\infty} \frac{dx}{x^2+a} &= \frac{d}{da} \left(-\frac{\pi}{2^2} \cdot \frac{1}{\sqrt{a^3}} \right) \\ &= \frac{1 \cdot 3\pi}{2^3} \cdot \frac{1}{\sqrt{a^5}}, \end{aligned}$$

.....

由数学归纳法, 可得

$$\frac{d^n}{da^n} \int_0^{+\infty} \frac{dx}{x^2+a} = \frac{(2n-1)!!\pi}{2^{n+1}} (-1)^n \cdot a^{-(n+\frac{1}{2})},$$

最后得

$$I = \frac{\pi}{2} \cdot \frac{(2n-1)!!}{(2n)!!} a^{-(n+\frac{1}{2})}.$$

3786. 证明迪里黑里积分

$$I(\alpha) = \int_0^{+\infty} \frac{\sin \alpha x}{x} dx$$

当 $\alpha \neq 0$ 时有导函数，但不能利用莱布尼兹法则来求它。

证 当 $\alpha > 0$ 时，令 $\alpha x = y$ ，得

$$I(\alpha) = \int_0^{+\infty} \frac{\sin y}{y} dy = \frac{\pi}{2}.$$

当 $\alpha < 0$ 时， $I(\alpha) = -I(-\alpha) = -\frac{\pi}{2}$ ，于是，

当 $\alpha \neq 0$ 时， $I'(\alpha) = 0$ 。

但是，如果利用莱布尼兹法则来求，即得错误的结果。事实上，积分

$$\int_0^{+\infty} \frac{\partial}{\partial \alpha} \left(\frac{\sin \alpha x}{x} \right) dx = \int_0^{+\infty} \cos \alpha x dx$$

发散，而 $I'(\alpha) = 0$ ($\alpha \neq 0$) 存在，因此，本题不能应用莱布尼兹法则求 $I'(\alpha)$ 。

3787. 证明：函数

$$F(\alpha) = \int_0^{+\infty} \frac{\cos x}{1+(x+\alpha)^2} dx$$

在区域 $-\infty < \alpha < +\infty$ 内连续并且可微分的。

证 设 α_0 为 $(-\infty, +\infty)$ 内任意一点。记 $M = \max(|\alpha_0 - 1|, |\alpha_0 + 1|)$ ，则当 $x > M$ ， $\alpha \in (\alpha_0 - 1, \alpha_0 + 1)$ 时，恒有

$$\left| \frac{\cos x}{1+(x+\alpha)^2} \right| \leq \frac{1}{1+(x-M)^2},$$

$$\left| \frac{\partial}{\partial \alpha} \left[\frac{\cos x}{1+(x+\alpha)^2} \right] \right| = \left| \frac{2(x+\alpha)\cos x}{[1+(x+\alpha)^2]^2} \right|$$

$$\leq \frac{2}{1+(x-M)^2}.$$

由于积分 $\int_0^{+\infty} \frac{dx}{1+(x-M)^2}$ 收敛, 故积分

$$\int_0^{+\infty} \frac{\cos x}{1+(x+\alpha)^2} dx$$

及 $\int_0^{+\infty} \frac{\partial}{\partial \alpha} \left[\frac{\cos x}{1+(x+\alpha)^2} \right] dx$

在 (α_0-1, α_0+1) 内一致收敛, 从而 $F(\alpha)$ 在 (α_0-1, α_0+1) 内连续且可微分, 且可在积分号下求导数. 由 α_0 的任意性, 即知 $F(\alpha)$ 在 $(-\infty, +\infty)$ 内连续且可微分.

3788. 从等式

$$\frac{e^{-ax} - e^{-bx}}{x} = \int_a^b e^{-xy} dy$$

出发, 计算积分

$$\int_0^{+\infty} \frac{e^{-ax} - e^{-bx}}{x} dx \quad (a > 0, b > 0).$$

解 不妨设 $a < b$. 注意到 e^{-xy} 在域: $x \geq 0, a \leq y \leq b$ 上连续. 又积分 $\int_0^{+\infty} e^{-xy} dx$ 对 $a \leq y \leq b$ 是一致收敛的. 事实上, 当 $x \geq 0, a \leq y \leq b$ 时,

$$0 < e^{-xy} \leq e^{-ax}.$$

但积分 $\int_0^{+\infty} e^{-ax} dx$ 收敛. 故积分 $\int_0^{+\infty} e^{-xy} dx$ 是一致收敛的. 于是, 利用对参数的积分公式, 即得

$$\int_0^{+\infty} dx \int_a^b e^{-xy} dy = \int_a^b dy \int_0^{+\infty} e^{-xy} dx.$$

上式左端为 $\int_0^{+\infty} \frac{e^{-ax} - e^{-bx}}{x} dx$, 右端为 $\int_a^b \frac{dy}{y} =$

$\ln \frac{b}{a}$. 从而得

$$\int_0^{+\infty} \frac{e^{-ax} - e^{-bx}}{x} dx = \ln \frac{b}{a} \quad (a > 0, b > 0).$$

3789. 证明傅茹兰公式

$$\begin{aligned} & \int_0^{+\infty} \frac{f(ax) - f(bx)}{x} dx \\ &= f(0) \ln \frac{b}{a} \quad (a > 0, b > 0), \end{aligned}$$

式中 $f(x)$ 为连续函数及积分 $\int_A^{+\infty} \frac{f(x)}{x} dx$ 对任何的 $A > 0$ 都有意义.

证 对任何的 $A > 0$, 有

$$\begin{aligned} & \int_A^{+\infty} \frac{f(ax) - f(bx)}{x} dx \\ &= \int_A^{+\infty} \frac{f(ax)}{x} dx - \int_A^{+\infty} \frac{f(bx)}{x} dx \\ &= \int_{Aa}^{+\infty} \frac{f(t)}{t} dt - \int_{Ab}^{+\infty} \frac{f(t)}{t} dt \end{aligned}$$

$$\begin{aligned}
 &= \int_{Aa}^{Ab} \frac{f(t)}{t} dt = f(\xi) \int_{Aa}^{Ab} \frac{dt}{t} \\
 &= f(\xi) \ln \frac{b}{a} \quad (Aa < \xi < Ab) .
 \end{aligned}$$

当 $A \rightarrow +0$ 时, $\xi \rightarrow +0$. 由 $f(x)$ 在 $x=0$ 点的连续性, 即得

$$\int_0^{+\infty} \frac{f(ax) - f(bx)}{x} dx = f(0) \ln \frac{b}{a} .$$

利用傅茹兰公式, 计算积分,

$$3790. \int_0^{+\infty} \frac{\cos ax - \cos bx}{x} dx \quad (a > 0, b > 0) .$$

解 由于 $\cos x$ 在 $[0, +\infty)$ 内连续, 且对任何 $A > 0$, 积分 $\int_A^{+\infty} \frac{\cos x}{x} dx$ 存在, 故由傅茹兰公式, 有

$$\begin{aligned}
 &\int_0^{+\infty} \frac{\cos ax - \cos bx}{x} dx \\
 &= \cos 0 \cdot \ln \frac{b}{a} = \ln \frac{b}{a} .
 \end{aligned}$$

$$3791. \int_0^{+\infty} \frac{\sin ax - \sin bx}{x} dx \quad (a > 0, b > 0) .$$

解 同3790题, 由于 $\sin 0 = 0$, 故

$$\int_0^{+\infty} \frac{\sin ax - \sin bx}{x} dx = 0 .$$

$$3792. \int_0^{+\infty} \frac{\operatorname{arctg} ax - \operatorname{arctg} bx}{x} dx \quad (a > 0, b > 0).$$

解 令 $f(x) = \frac{\pi}{2} - \operatorname{arctg} x$, 则 $f(x)$ 在 $0 \leq x < +\infty$ 上连续.

由于 $f(x) > 0$ 且 (利用洛比塔法则)

$$\begin{aligned} \lim_{x \rightarrow +\infty} x^2 \cdot \frac{f(x)}{x} &= \lim_{x \rightarrow +\infty} \frac{\frac{\pi}{2} - \operatorname{arctg} x}{x^{-1}} \\ &= \lim_{x \rightarrow +\infty} \frac{-\frac{1}{1+x^2}}{-\frac{1}{x^2}} = 1, \end{aligned}$$

故对任何 $A > 0$, 积分 $\int_A^{+\infty} \frac{f(x)}{x} dx$ 都收敛. 因此由傅茹兰公式, 有

$$\begin{aligned} &\int_0^{+\infty} \frac{\left(\frac{\pi}{2} - \operatorname{arctg} ax\right) - \left(\frac{\pi}{2} - \operatorname{arctg} bx\right)}{x} dx \\ &= \frac{\pi}{2} \ln \frac{b}{a}, \end{aligned}$$

故

$$\int_0^{+\infty} \frac{\operatorname{arctg} ax - \operatorname{arctg} bx}{x} dx = \frac{\pi}{2} \ln \frac{a}{b}.$$

利用对参数的微分法计算下列积分:

$$3793. \int_0^{+\infty} \frac{e^{-ax^2} - e^{-\beta x^2}}{x} dx \quad (a > 0, \beta > 0).$$

解 由于

$$\begin{aligned} & \lim_{x \rightarrow +0} \frac{e^{-\alpha x^2} - e^{-\beta x^2}}{x} \\ &= \lim_{x \rightarrow +0} \frac{-2\alpha x e^{-\alpha x^2} + 2\beta x e^{-\beta x^2}}{1} = 0, \end{aligned}$$

故 $x=0$ 不是瑕点. 又由于

$$\begin{aligned} & \lim_{x \rightarrow +\infty} x^2 \cdot \frac{e^{-\alpha x^2} - e^{-\beta x^2}}{x} \\ &= \lim_{x \rightarrow +\infty} \left(\frac{x}{e^{\alpha x^2}} - \frac{x}{e^{\beta x^2}} \right) = 0, \end{aligned}$$

故对任何 $\alpha > 0$, $\beta > 0$ 积分 $\int_0^{+\infty} \frac{e^{-\alpha x^2} - e^{-\beta x^2}}{x} dx$ 都收敛. 今将 $\beta > 0$ 固定, 而把所求积分视为含参变量 α ($\alpha > 0$) 的积分, 即令

$$I(\alpha) = \int_0^{+\infty} \frac{e^{-\alpha x^2} - e^{-\beta x^2}}{x} dx \quad (\alpha > 0).$$

而

$$\begin{aligned} & \int_0^{+\infty} \frac{\partial}{\partial \alpha} \left(\frac{e^{-\alpha x^2} - e^{-\beta x^2}}{x} \right) dx \\ &= - \int_0^{+\infty} x e^{-\alpha x^2} dx. \end{aligned}$$

下证右端积分在 $\alpha \geq \alpha_0 > 0$ 时一致收敛. 事实上, 当 $\alpha \geq \alpha_0$, $0 \leq x < +\infty$ 时, $0 \leq x e^{-\alpha x^2} \leq x e^{-\alpha_0 x^2}$, 而积分 $\int_0^{+\infty} x e^{-\alpha_0 x^2} dx = \frac{1}{2\alpha_0}$ 收敛, 故积分

$\int_0^{+\infty} x e^{-ax^2} dx$ 在 $a \geq \alpha_0$ 时一致收敛. 因此, 当 $a \geq \alpha_0$ 时, 可在积分号下对参数求导数:

$$I'(a) = - \int_0^{+\infty} x e^{-ax^2} dx = -\frac{1}{2a}.$$

由 $\alpha_0 > 0$ 的任意性知, 上式对一切 $a > 0$ 皆成立. 积分之, 得

$$I(a) = -\frac{1}{2} \ln a + C \quad (0 < a < +\infty),$$

其中 C 为待定的常数. 在此式中令 $a = \beta$, 并注意到

$$I(\beta) = \int_0^{+\infty} \frac{e^{-\beta x^2} - e^{-\beta x^2}}{x} dx = 0, \text{ 即得}$$

$$0 = I(\beta) = -\frac{1}{2} \ln \beta + C,$$

由此知 $C = \frac{1}{2} \ln \beta$. 于是,

$$I(a) = -\frac{1}{2} \ln a + \frac{1}{2} \ln \beta = \frac{1}{2} \ln \frac{\beta}{a} \quad (a > 0),$$

即

$$\int_0^{+\infty} \frac{e^{-ax^2} - e^{-\beta x^2}}{x} dx = \frac{1}{2} \ln \frac{\beta}{a} \quad (a > 0, \beta > 0).$$

注. 本题中, 实际应考察积分 $I(a) = \int_0^{+\infty} f(x, a) dx$,

$$\text{其中 } f(x, a) = \begin{cases} \frac{e^{-ax^2} - e^{-\beta x^2}}{x}, & \text{当 } 0 < x < +\infty \text{ 时,} \\ 0, & \text{当 } x = 0 \text{ 时.} \end{cases}$$

易知 $f(x, \alpha)$ 是 $0 \leq x < +\infty$, $0 < \alpha < +\infty$ 上的连续函数 ($\beta > 0$ 固定). 我们证明:

$$f'_\alpha(x, \alpha) = -x e^{-\alpha x^2} \quad (0 \leq x < +\infty, 0 < \alpha < +\infty).$$

事实上, 当 $0 < x < +\infty$ 时, 此式显然成立. 由于 $f(0, \alpha) \equiv 0$ ($0 < \alpha < +\infty$), 故 $f'_\alpha(0, \alpha) = 0$ ($0 < \alpha < +\infty$). 因此, 上式当 $x = 0$ 时也成立. $f'_\alpha(x, \alpha)$ 显然是 $0 \leq x < +\infty$, $0 < \alpha < +\infty$ 上的连续函数.

在以下许多题中, 我们都应作此理解, 但不必写出 $f(x, \alpha)$. 函数 $\frac{e^{-\alpha x^2} - e^{-\beta x^2}}{x}$ 就代表 $f(x, \alpha)$

($x = 0$ 时规定其函数值为其极限值 0), 而公式

$$\frac{\partial}{\partial \alpha} \left(\frac{e^{-\alpha x^2} - e^{-\beta x^2}}{x} \right) = -x e^{-\alpha x^2}$$

当 $x = 0$ 时也成立 (如上述). 这样, 才严格符合莱布尼兹法则 (积分号下求导数) 的条件.

另外, 本题若利用逐次积分来作可更简单一些. 今作如下: 易知 (不妨设 $\alpha \leq \beta$)

$$\frac{e^{-\alpha x^2} - e^{-\beta x^2}}{x} = \int_\alpha^\beta x e^{-y x^2} dy,$$

而积分 $\int_0^{+\infty} x e^{-y x^2} dx$ 当 $\alpha \leq y \leq \beta$ 时一致收敛 (因

为 $0 \leq x e^{-y x^2} \leq x e^{-\alpha x^2}$, 而 $\int_0^{+\infty} x e^{-\alpha x^2} dx$ 收敛),

故可交换积分次序, 得

$$\begin{aligned}
& \int_0^{+\infty} \frac{e^{-\alpha x^2} - e^{-\beta x^2}}{x} dx \\
&= \int_0^{+\infty} dx \int_{\alpha}^{\beta} x e^{-yx^2} dy \\
&= \int_{\alpha}^{\beta} dy \int_0^{+\infty} x e^{-yx^2} dx \\
&= \int_{\alpha}^{\beta} \frac{dy}{2y} = \frac{1}{2} \ln \frac{\beta}{\alpha}.
\end{aligned}$$

3794. $\int_0^{+\infty} \left(\frac{e^{-\alpha x} - e^{-\beta x}}{x} \right)^2 dx \quad (\alpha > 0, \beta > 0)$

解 由于

$$\begin{aligned}
& \lim_{x \rightarrow +0} \frac{e^{-\alpha x} - e^{-\beta x}}{x} \\
&= \lim_{x \rightarrow +0} \frac{-\alpha e^{-\alpha x} + \beta e^{-\beta x}}{1} = \beta - \alpha,
\end{aligned}$$

故 $x=0$ 不是瑕点, 又由于

$$\lim_{x \rightarrow +\infty} x^2 \cdot \left(\frac{e^{-\alpha x} - e^{-\beta x}}{x} \right)^2 = 0,$$

故积分 $\int_0^{+\infty} \left(\frac{e^{-\alpha x} - e^{-\beta x}}{x} \right)^2 dx$ 收敛 ($\alpha > 0, \beta > 0$).

同样, 将 $\beta > 0$ 固定, 考虑含参变量 α 的积分:

$$I(\alpha) = \int_0^{+\infty} \left(\frac{e^{-\alpha x} - e^{-\beta x}}{x} \right)^2 dx \quad (\alpha > 0).$$

由于

$$\begin{aligned}
& \int_0^{+\infty} \frac{\partial}{\partial \alpha} \left(\frac{e^{-\alpha x} - e^{-\beta x}}{x} \right)^2 dx \\
&= -2 \int_0^{+\infty} \frac{e^{-2\alpha x} - e^{-(\alpha+\beta)x}}{x} dx \\
&= -2 \ln \frac{\alpha + \beta}{2\alpha} \quad (a > 0).
\end{aligned}$$

而当 $\alpha \geq \alpha_0 > 0$, $1 \leq x < +\infty$ 时,

$$\left| \frac{e^{-2\alpha x} - e^{-(\alpha+\beta)x}}{x} \right| \leq \frac{2e^{-\alpha_0 x}}{x},$$

且 $\int_1^{+\infty} \frac{e^{-\alpha_0 x}}{x} dx$ 收敛 (因为 $\lim_{x \rightarrow +\infty} x^2 \cdot \frac{e^{-\alpha_0 x}}{x} = 0$),

故 $\int_1^{+\infty} \frac{e^{-2\alpha x} - e^{-(\alpha+\beta)x}}{x} dx$ 当 $\alpha \geq \alpha_0$ 时一致收敛,

从而 $\int_0^{+\infty} \frac{e^{-2\alpha x} - e^{-(\alpha+\beta)x}}{x} dx$ 当 $\alpha \geq \alpha_0$ 时一致收敛

(注意, 因为 $\lim_{x \rightarrow +0} \frac{e^{-2\alpha x} - e^{-(\alpha+\beta)x}}{x} = \beta - \alpha$, 故 $x=0$

不是瑕点). 因此, 根据莱布尼兹法则, 当 $\alpha \geq \alpha_0$ 时

可在积分号下求导数:

$$\begin{aligned}
I'(a) &= \int_0^{+\infty} \frac{\partial}{\partial \alpha} \left(\frac{e^{-\alpha x} - e^{-\beta x}}{x} \right)^2 dx \\
&= -2 \ln \frac{\alpha + \beta}{2\alpha}.
\end{aligned}$$

由 $\alpha_0 > 0$ 的任意性知, 上式对一切 $\alpha > 0$ 皆成立.

积分之，并注意到

$$\int \ln \frac{\alpha + \beta}{2\alpha} d\alpha = \alpha \ln \frac{\alpha + \beta}{2\alpha} + \beta \ln(\alpha + \beta) + C,$$

即得

$$I(\alpha) = -2\alpha \ln \frac{\alpha + \beta}{2\alpha} - 2\beta \ln(\alpha + \beta) + C_1,$$

其中 C_1 是待定常数。令 $\alpha = \beta$ ，则由于 $I(\beta) = 0$ ，得

$$0 = -2\beta \ln \frac{2\beta}{2\beta} - 2\beta \ln 2\beta + C_1,$$

故 $C_1 = 2\beta \ln 2\beta$ 。于是，得

$$\begin{aligned} I(\alpha) &= \ln \left(\frac{2\alpha}{\alpha + \beta} \right)^{2\alpha} - 2\beta \ln(\alpha + \beta) + 2\beta \ln 2\beta \\ &= \ln \frac{(2\alpha)^{2\alpha} (2\beta)^{2\beta}}{(\alpha + \beta)^{2\alpha + 2\beta}}, \end{aligned}$$

即

$$\begin{aligned} & \int_0^{+\infty} \left(\frac{e^{-\alpha x} - e^{-\beta x}}{x} \right)^2 dx \\ &= \ln \frac{(2\alpha)^{2\alpha} (2\beta)^{2\beta}}{(\alpha + \beta)^{2\alpha + 2\beta}} \quad (\alpha > 0, \beta > 0). \end{aligned}$$

*) 利用3788题的结果。

$$3795. \int_0^{+\infty} \frac{e^{-\alpha x} - e^{-\beta x}}{x} \sin mx dx \quad (\alpha > 0, \beta > 0).$$

解 当 $m = 0$ 时，

$$\int_0^{+\infty} \frac{e^{-\alpha x} - e^{-\beta x}}{x} \sin mx \, dx = 0,$$

故下设 $m \neq 0$ 。由于

$$\lim_{x \rightarrow +0} \frac{e^{-\alpha x} - e^{-\beta x}}{x} \sin mx = 0,$$

故 $x = 0$ 不是瑕点，从而被积函数在域： $0 \leq x < +\infty$ 及 $\alpha > 0, \beta > 0$ 内连续 ($x = 0$ 时的函数值理解为极限值)。又由于

$$\left| \frac{e^{-\alpha x} - e^{-\beta x}}{x} \sin mx \right| \leq \frac{e^{-\alpha x} + e^{-\beta x}}{x} \quad (x > 0),$$

而积分 $\int_1^{+\infty} \frac{e^{-\alpha x} + e^{-\beta x}}{x} \, dx$ 收敛，故积分

$\int_1^{+\infty} \frac{e^{-\alpha x} - e^{-\beta x}}{x} \sin mx \, dx$ 收敛，从而积分

$$\int_0^{+\infty} \frac{e^{-\alpha x} - e^{-\beta x}}{x} \sin mx \, dx$$

收敛。当 $\alpha \geq \alpha_0 > 0$ 时，积分

$$\begin{aligned} & \int_0^{+\infty} \frac{\partial}{\partial \alpha} \left(\frac{e^{-\alpha x} - e^{-\beta x}}{x} \sin mx \right) dx \\ &= - \int_0^{+\infty} e^{-\alpha x} \sin mx \, dx \end{aligned}$$

是一致收敛的。事实上，

$$|e^{-\alpha x} \sin mx| \leq e^{-\alpha_0 x} \quad (x \geq 0),$$

而积分 $\int_0^{+\infty} e^{-\alpha_0 x} \, dx = \frac{1}{\alpha_0}$ 收敛。于是，对于积分

$$I(a) = \int_0^{+\infty} \frac{e^{-ax} - e^{-\beta x}}{x} \sin mx \, dx$$

当 $a \geq a_0$ 时可应用莱布尼兹法则, 得

$$I'(a) = - \int_0^{+\infty} e^{-ax} \sin mx \, dx = - \frac{m}{a^2 + m^2} \quad *)$$

由 $a_0 > 0$ 的任意性知, 上式对一切 $a > 0$ 均成立. 从而

$$I(a) = - \int \frac{m}{a^2 + m^2} \, da = - \operatorname{arc} \operatorname{tg} \frac{a}{m} + C,$$

其中 C 是待定常数. 令 $a = \beta$, 则得

$$I(\beta) = 0 = - \operatorname{arc} \operatorname{tg} \frac{\beta}{m} + C,$$

故 $C = \operatorname{arc} \operatorname{tg} \frac{\beta}{m}$. 最后得

$$\begin{aligned} & \int_0^{+\infty} \frac{e^{-ax} - e^{-\beta x}}{x} \sin mx \, dx \\ &= \operatorname{arc} \operatorname{tg} \frac{\beta}{m} - \operatorname{arc} \operatorname{tg} \frac{a}{m} \quad (m \neq 0). \end{aligned}$$

*) 利用1829题的结果.

$$3796. \int_0^{+\infty} \frac{e^{-ax} - e^{-\beta x}}{x} \cos mx \, dx \quad (a > 0, \beta > 0).$$

解 同3795题, 我们可证明: 当 $a \geq a_0 > 0$ 时, 对积分

$$I(a) = \int_0^{+\infty} \frac{e^{-ax} - e^{-\beta x}}{x} \cos mx \, dx$$

可应用莱布尼兹法则, 得

$$\begin{aligned} I'(a) &= \int_0^{+\infty} \frac{\partial}{\partial a} \left(\frac{e^{-ax} - e^{-\beta x}}{x} \cos mx \right) dx \\ &= - \int_0^{+\infty} e^{-ax} \cos mx \, dx = - \frac{a}{a^2 + m^2} \quad *) \end{aligned}$$

由 $a_0 > 0$ 的任意性知, 上式对一切 $a > 0$ 均成立. 从而

$$I(a) = - \int \frac{a \, da}{a^2 + m^2} = - \frac{1}{2} \ln(a^2 + m^2) + C,$$

其中 C 是待定常数. 令 $a = \beta$, 则得

$$I(\beta) = 0 = - \frac{1}{2} \ln(\beta^2 + m^2) + C,$$

故 $C = \frac{1}{2} \ln(\beta^2 + m^2)$. 最后得

$$\begin{aligned} & \int_0^{+\infty} \frac{e^{-ax} - e^{-\beta x}}{x} \cos mx \, dx \\ &= \frac{1}{2} \ln \frac{\beta^2 + m^2}{a^2 + m^2} \quad (a > 0, \beta > 0). \end{aligned}$$

*) 利用1828题的结果.

计算下列积分:

$$3797. \int_0^1 \frac{\ln(1 - a^2 x^2)}{x^2 \sqrt{1 - x^2}} dx \quad (|\alpha| \leq 1).$$

解 由于

$$\lim_{x \rightarrow +0} \frac{\ln(1 - a^2 x^2)}{x^2 \sqrt{1 - x^2}} = \lim_{x \rightarrow +0} \frac{\ln(1 - a^2 x^2)}{x^2}$$

$$= \lim_{x \rightarrow +0} \frac{-\frac{2a^2x}{1-a^2x^2}}{2x} = -a^2,$$

故 $x=0$ 不是瑕点，从而被积函数在域： $0 \leq x < 1$ 及 $|a| \leq 1$ 内连续（ $x=0$ 时的函数值理解为极限值），又由于当 $|a| \leq 1$ 时，

$$\left| \frac{\ln(1-a^2x^2)}{x^2\sqrt{1-x^2}} \right| \leq \frac{\ln(1-x^2)}{x^2\sqrt{1-x^2}} \quad (0 < x < 1),$$

而积分 $\int_0^1 \frac{\ln(1-x^2)}{x^2\sqrt{1-x^2}} dx$ 收敛（因为 $\lim_{x \rightarrow 1-0} (1-x)^{\frac{3}{2}}$

$$\cdot \frac{\ln(1-x^2)}{x^2\sqrt{1-x^2}} = \lim_{x \rightarrow 1-0} (1-x)^{\frac{1}{2}} \cdot \frac{\ln(1-x^2)}{x^2\sqrt{1+x}} = 0$$

故积分

$$\int_0^1 \frac{\ln(1-a^2x^2)}{x^2\sqrt{1-x^2}} dx$$

对 $|a| \leq 1$ 一致收敛，从而为 a 的连续函数（ $-1 \leq a \leq 1$ ），另一方面，易知积分

$$\begin{aligned} & \int_0^1 \frac{\partial}{\partial a} \left[\frac{\ln(1-a^2x^2)}{x^2\sqrt{1-x^2}} \right] dx \\ &= -2a \int_0^1 \frac{dx}{(1-a^2x^2)\sqrt{1-x^2}} \end{aligned}$$

对 $|a| \leq a_0 < 1$ 一致收敛，事实上，

$$\begin{aligned} & \left| \frac{-2a}{(1-a^2x^2)\sqrt{1-x^2}} \right| \\ & \leq \frac{2}{1-a_0^2} \cdot \frac{1}{\sqrt{1-x^2}} \quad (0 \leq x < 1), \end{aligned}$$

而积分 $\int_0^1 \frac{dx}{\sqrt{1-x^2}} = \frac{\pi}{2}$ 收敛。于是，对积分

$$I(\alpha) = \int_0^1 \frac{\ln(1-\alpha^2 x^2)}{x^2 \sqrt{1-x^2}} dx$$

当 $|\alpha| \leq \alpha_0$ 时可应用莱布尼兹法则，得

$$I'(\alpha) = -2\alpha \int_0^1 \frac{dx}{(1-\alpha^2 x^2) \sqrt{1-x^2}}.$$

由 $\alpha_0 < 1$ 的任意性知，上式对一切 $|\alpha| < 1$ 均成立。
先求不定积分

$$I_1 = \int \frac{dx}{(1-\alpha^2 x^2) \sqrt{1-x^2}}.$$

作代换 $x = \sin t$ ，易得

$$\begin{aligned} I_1 &= \int \frac{dt}{1-\alpha^2 \sin^2 t} \\ &= \frac{1}{2} \left(\int \frac{dt}{1-\alpha \sin t} + \int \frac{dt}{1+\alpha \sin t} \right). \end{aligned}$$

再对右端两个积分作代换 $u = \operatorname{tg} \frac{t}{2}$ ，可得

$$\begin{aligned} &\int \frac{dt}{1-\alpha \sin t} \\ &= \frac{2}{\sqrt{1-\alpha^2}} \operatorname{arc} \operatorname{tg} \left(\frac{\operatorname{tg} \frac{t}{2} - \alpha}{\sqrt{1-\alpha^2}} \right) + C_1, \\ &\int \frac{dt}{1+\alpha \sin t} \end{aligned}$$

$$= \frac{2}{\sqrt{1-\alpha^2}} \operatorname{arc} \operatorname{tg} \left(\frac{\operatorname{tg} \frac{t}{2} + \alpha}{\sqrt{1-\alpha^2}} \right) + C_2.$$

从而

$$\begin{aligned} I'(\alpha) &= 2\alpha \int_0^{\frac{\pi}{2}} \frac{1}{2} \left(\frac{1}{1-\alpha \sin t} \right. \\ &\quad \left. + \frac{1}{1+\alpha \sin t} \right) dt \\ &= -\frac{2\alpha}{\sqrt{1-\alpha^2}} \left[\operatorname{arc} \operatorname{tg} \left(\frac{\operatorname{tg} \frac{t}{2} - \alpha}{\sqrt{1-\alpha^2}} \right) \right. \\ &\quad \left. + \operatorname{arc} \operatorname{tg} \left(\frac{\operatorname{tg} \frac{t}{2} + \alpha}{\sqrt{1-\alpha^2}} \right) \right] \Big|_0^{\frac{\pi}{2}} \\ &= -\frac{\pi\alpha}{\sqrt{1-\alpha^2}} \quad (|\alpha| < 1). \end{aligned}$$

两端积分, 得

$$\begin{aligned} I(\alpha) &= -\pi \int \frac{\alpha d\alpha}{\sqrt{1-\alpha^2}} \\ &= \pi \sqrt{1-\alpha^2} + C \quad (|\alpha| < 1), \end{aligned}$$

其中 C 是待定常数. 令 $\alpha = 0$, 得

$$I(0) = 0 = \pi + C,$$

故 $C = -\pi$, 从而

$$I(\alpha) = -\pi(1 - \sqrt{1-\alpha^2}) \quad (|\alpha| < 1).$$

在此式两端令 $\alpha \rightarrow 1 - 0$ 及 $\alpha \rightarrow -1 + 0$ 取极限, 并注意到 $I(\alpha)$ 在 $-1 \leq \alpha \leq 1$ 上的连续性, 即得

$$I(1) = I(-1) = -\pi.$$

于是, 当 $|a| \leq 1$ 时,

$$\int_0^1 \frac{\ln(1-a^2x^2)}{x^2\sqrt{1-x^2}} dx = -\pi(1-\sqrt{1-a^2}).$$

3798. $\int_0^1 \frac{\ln(1-a^2x^2)}{\sqrt{1-x^2}} dx \quad (|a| \leq 1).$

解 同3797题, 我们可以证明:

$$I(a) = \int_0^1 \frac{\ln(1-a^2x^2)}{\sqrt{1-x^2}} dx$$

当 $-1 \leq a \leq 1$ 时连续, 且当 $|a| \leq a_0 < 1$ 时可应用莱布尼兹法则. 于是,

$$\begin{aligned} I'(a) &= \int_0^1 \frac{\partial}{\partial a} \left[\frac{\ln(1-a^2x^2)}{\sqrt{1-x^2}} \right] dx \\ &= \int_0^1 \frac{-2ax^2}{(1-a^2x^2)\sqrt{1-x^2}} dx \\ &= \frac{2}{a} \int_0^1 \frac{(1-a^2x^2)-1}{(1-a^2x^2)\sqrt{1-x^2}} dx \\ &= \frac{2}{a} \int_0^1 \frac{dx}{\sqrt{1-x^2}} \\ &\quad - \frac{2}{a} \int_0^1 \frac{dx}{(1-a^2x^2)\sqrt{1-x^2}} \\ &= \frac{2}{a} \cdot \frac{\pi}{2} - \frac{2}{a} \cdot \frac{\pi}{2\sqrt{1-a^2}} \\ &= \frac{\pi}{a} - \frac{\pi}{a\sqrt{1-a^2}} \quad (|a| \leq a_0, a \neq 0). \end{aligned}$$

由 $\alpha_0 < 1$ 的任意性知, 上式对一切 $0 < |\alpha| < 1$ 均成立. 积分得

$$\begin{aligned} I(\alpha) &= \int \left(\frac{\pi}{\alpha} - \frac{\pi}{\alpha \sqrt{1-\alpha^2}} \right) d\alpha \\ &= \pi \ln |\alpha| + \pi \ln \left| \frac{1 + \sqrt{1-\alpha^2}}{\alpha} \right| + C \\ &= \pi \ln (1 + \sqrt{1-\alpha^2}) + C, \end{aligned}$$

其中 $|\alpha| < 1$, $\alpha \neq 0$, C 为待定常数. 令 $\alpha \rightarrow 0$, 并注意到 $I(\alpha)$ 在 $\alpha = 0$ 的连续性, 即得

$$I(0) = 0 = \pi \ln 2 + C,$$

故 $C = -\pi \ln 2$, 从而得

$$I(\alpha) = \pi \ln \frac{1 + \sqrt{1-\alpha^2}}{2} \quad (|\alpha| < 1).$$

在上式中令 $\alpha \rightarrow 1-0$ 及 $\alpha \rightarrow -1+0$, 并注意到 $I(\alpha)$ 在 $-1 \leq \alpha \leq 1$ 上的连续性, 即知上式当 $\alpha = \pm 1$ 时也成立, 即

$$\begin{aligned} &\int_0^1 \frac{\ln(1-\alpha^2 x^2)}{\sqrt{1-x^2}} dx \\ &= \pi \ln \frac{1 + \sqrt{1-\alpha^2}}{2} \quad (|\alpha| \leq 1). \end{aligned}$$

3799. $\int_1^{+\infty} \frac{\arctg \alpha x}{x^2 \sqrt{x^2-1}} dx.$

解 设 $I(\alpha) = \int_1^{+\infty} \frac{\arctg \alpha x}{x^2 \sqrt{x^2-1}} dx$. 显然有 $I(0) = 0$.

当 $\alpha > 0$ 时, 由于 $\lim_{x \rightarrow +\infty} x^3 \cdot \frac{\arctg \alpha x}{x^2 \sqrt{x^2 - 1}} = \frac{\pi}{2}$, 故

$I(\alpha)$ 收敛. 其次, 易知积分

$$\begin{aligned} & \int_1^{+\infty} \frac{\partial}{\partial \alpha} \left(\frac{\arctg \alpha x}{x^2 \sqrt{x^2 - 1}} \right) dx \\ &= \int_1^{+\infty} \frac{dx}{x(1 + \alpha^2 x^2) \sqrt{x^2 - 1}} \\ &= \int_0^1 \frac{t^2 dt}{\sqrt{1 - t^2}(t^2 + \alpha^2)} \end{aligned}$$

对 $\alpha \geq 0$ 一致收敛. 事实上, 当 $\alpha \geq 0$, $0 \leq t < 1$ 时, 有

$$\left| \frac{t^2}{\sqrt{1 - t^2}(t^2 + \alpha^2)} \right| \leq \frac{1}{\sqrt{1 - t^2}},$$

且 $\int_0^1 \frac{dt}{\sqrt{1 - t^2}}$ 收敛. 于是, 可应用莱布尼兹法则, 得

$$\begin{aligned} I'(\alpha) &= \int_1^{+\infty} \frac{\partial}{\partial \alpha} \left(\frac{\arctg \alpha x}{x^2 \sqrt{x^2 - 1}} \right) dx \\ &= \int_0^1 \frac{t^2 dt}{\sqrt{1 - t^2}(t^2 + \alpha^2)} \\ &= \int_0^1 \frac{(t^2 + \alpha^2) - \alpha^2}{\sqrt{1 - t^2}(t^2 + \alpha^2)} dt \\ &= \int_0^1 \frac{dt}{\sqrt{1 - t^2}} \end{aligned}$$

$$\begin{aligned}
& -a^2 \int_0^1 \frac{dt}{\sqrt{1-t^2}(t^2+a^2)} \\
&= \frac{\pi}{2} - a^2 \cdot \frac{\pi}{2a\sqrt{a^2+1}} \\
&= \frac{\pi}{2} - \frac{a\pi}{2\sqrt{1+a^2}} \quad (a \geq 0).
\end{aligned}$$

从而有

$$\begin{aligned}
I(a) &= \frac{\pi}{2} a - \frac{\pi}{2} \int \frac{a da}{\sqrt{1+a^2}} \\
&= \frac{\pi}{2} a - \frac{\pi}{2} \sqrt{1+a^2} + C \quad (a \geq 0),
\end{aligned}$$

其中 C 为待定常数. 令 $a=0$, 得

$$I(0) = 0 = -\frac{\pi}{2} + C,$$

故 $C = \frac{\pi}{2}$. 于是, 当 $a \geq 0$ 时,

$$\int_1^{+\infty} \frac{\operatorname{arc} \operatorname{tg} ax}{x^2 \sqrt{x^2-1}} dx = \frac{\pi}{2} (1+a-\sqrt{1+a^2}).$$

当 $a < 0$ 时,

$$\begin{aligned}
& \int_1^{+\infty} \frac{\operatorname{arc} \operatorname{tg} ax}{x^2 \sqrt{x^2-1}} dx \\
&= - \int_1^{+\infty} \frac{\operatorname{arc} \operatorname{tg}(-a)x}{x^2 \sqrt{x^2-1}} dx \\
&= -\frac{\pi}{2} (1-a-\sqrt{1+a^2}).
\end{aligned}$$

于是, 当 $-\infty < a < +\infty$ 时,

$$\begin{aligned} & \int_1^{+\infty} \frac{\operatorname{arc\,tg} ax}{x^2 \sqrt{x^2 - 1}} dx \\ &= \frac{\pi}{2} (1 + |a| - \sqrt{1 + a^2}) \operatorname{sgn} a. \end{aligned}$$

3800. $\int_0^{+\infty} \frac{\ln(\alpha^2 + x^2)}{\beta^2 + x^2} dx.$

解 我们首先计算积分

$$I_\beta(\alpha) = \int_0^{+\infty} \frac{\ln(1 + \alpha^2 x^2)}{\beta^2 + x^2} dx$$

($\alpha \geq 0$ 是参数, $\beta > 0$ 固定).

首先注意, 此积分当 $0 \leq \alpha \leq \alpha_1$ ($\alpha_1 > 0$ 为任何有限数) 时一致收敛. 事实上, 当 $0 \leq \alpha \leq \alpha_1$ 时,

$$\begin{aligned} 0 &\leq \frac{\ln(1 + \alpha^2 x^2)}{\beta^2 + x^2} \\ &\leq \frac{\ln(1 + \alpha_1^2 x^2)}{\beta^2 + x^2} \quad (0 \leq x < +\infty), \end{aligned}$$

而积分 $\int_0^{+\infty} \frac{\ln(1 + \alpha_1^2 x^2)}{\beta^2 + x^2} dx$ 收敛 (因为易知

$$\lim_{x \rightarrow +\infty} x^{\frac{3}{2}} \cdot \frac{\ln(1 + \alpha_1^2 x^2)}{\beta^2 + x^2} = 0).$$

于是, $I_\beta(\alpha)$ 是 $0 \leq \alpha \leq \alpha_1$ 上的连续函数. 由 $\alpha_1 > 0$ 的任意性知, $I_\beta(\alpha)$ 当 $0 \leq \alpha < +\infty$ 时连续.

其次, 易证积分

$$\int_0^{+\infty} \frac{\partial}{\partial \alpha} \left[\frac{\ln(1 + \alpha^2 x^2)}{\beta^2 + x^2} \right] dx$$

$$= \int_0^{+\infty} \frac{2\alpha x^2}{(\beta^2 + x^2)(1 + \alpha^2 x^2)} dx = \frac{\pi}{\alpha\beta + 1}$$

当 $0 < \alpha_0 \leq \alpha \leq \alpha_1$ 时是一致收敛的。事实上，此时

$$0 \leq \frac{2\alpha x^2}{(\beta^2 + x^2)(1 + \alpha^2 x^2)}$$

$$\leq \frac{2\alpha_1 x^2}{(\beta^2 + x^2)(1 + \alpha_0^2 x^2)} \quad (0 \leq x < +\infty),$$

而积分 $\int_0^{+\infty} \frac{2\alpha_1 x^2}{(\beta^2 + x^2)(1 + \alpha_0^2 x^2)} dx$ 收敛。于是，

根据莱布尼兹法则，当 $0 < \alpha_0 \leq \alpha \leq \alpha_1$ 时，可在积分号下求导数，得

$$I'_\beta(\alpha) = \frac{\pi}{\alpha\beta + 1}.$$

由 α_1 与 α_0 的任意性知，上式对一切 $0 < \alpha < +\infty$ 均成立。两端积分，得

$$I_\beta(\alpha) = \frac{\pi}{\beta} \ln(1 + \alpha\beta) + C \quad (0 < \alpha < +\infty),$$

其中 C 是某常数。在此式中令 $\alpha \rightarrow +0$ 取极限，并注意到 $I_\beta(\alpha)$ 在 $0 \leq \alpha < +\infty$ 上连续，得

$$0 = I_\beta(0) = 0 + C,$$

故 $C = 0$ 。因此

$$I_\beta(\alpha) = \frac{\pi}{\beta} \ln(1 + \alpha\beta) \quad (0 \leq \alpha < +\infty).$$

对于所求积分，只要作适当变形即得。当 $\alpha > 0$ ， $\beta > 0$ 时，有

$$\begin{aligned} & \int_0^{+\infty} \frac{\ln(\alpha^2 + x^2)}{\beta^2 + x^2} dx \\ &= \int_0^{+\infty} \frac{2 \ln \alpha + \ln\left(1 + \frac{1}{\alpha^2} x^2\right)}{\beta^2 + x^2} dx \\ &= 2 \ln \alpha \int_0^{+\infty} \frac{dx}{\beta^2 + x^2} \\ & \quad + \int_0^{+\infty} \frac{\ln\left(1 + \frac{1}{\alpha^2} x^2\right)}{\beta^2 + x^2} dx \\ &= \frac{\pi \ln \alpha}{\beta} + \frac{\pi}{\beta} \ln\left(1 + \frac{\beta}{\alpha}\right) = \frac{\pi}{\beta} \ln(\alpha + \beta). \end{aligned}$$

此式当 $\alpha = 0$ 时也成立，只要在两端令 $\alpha \rightarrow +0$ 取极限即可。这是因为积分 $J(\alpha) = \int_0^{+\infty} \frac{\ln(\alpha^2 + x^2)}{\beta^2 + x^2} dx$

($\beta > 0$ 固定) 当 $0 \leq \alpha \leq \frac{1}{2}$ 时一致收敛 (易知

$\int_0^{\frac{1}{2}} \frac{\ln(\alpha^2 + x^2)}{\beta^2 + x^2} dx$ 与 $\int_{\frac{1}{2}}^{+\infty} \frac{\ln(\alpha^2 + x^2)}{\beta^2 + x^2} dx$ 当 $0 \leq \alpha$

$\leq \frac{1}{2}$ 时都一致收敛，事实上，

$$\begin{aligned} & \left| \frac{\ln(\alpha^2 + x^2)}{\beta^2 + x^2} \right| \\ & \leq -\frac{2 \ln x}{\beta^2 + x^2} \left(0 < x \leq \frac{1}{2}, 0 \leq \alpha \leq \frac{1}{2} \right), \end{aligned}$$

而 $\int_0^{\frac{1}{2}} \frac{\ln x}{\beta^2 + x^2} dx$ 收敛,

$$0 \leq \frac{\ln(\alpha^2 + x^2)}{\beta^2 + x^2}$$

$$\leq \frac{\ln\left(\frac{1}{4} + x^2\right)}{\beta^2 + x^2} \quad \left(\frac{1}{2} \leq x < +\infty, 0 \leq \alpha \leq \frac{1}{2}\right),$$

而 $\int_{\frac{1}{2}}^{+\infty} \frac{\ln\left(\frac{1}{4} + x^2\right)}{\beta^2 + x^2} dx$ 收敛, 故 $J(a)$ 在点 $a=0$ (右) 连续.

对于任意的 a 与 β ($\beta \neq 0$), 有

$$\begin{aligned} & \int_0^{+\infty} \frac{\ln(\alpha^2 + x^2)}{\beta^2 + x^2} dx \\ &= \int_0^{+\infty} \frac{\ln(|\alpha|^2 + x^2)}{|\beta|^2 + x^2} dx = \frac{\pi}{|\beta|} \ln(|\alpha| + |\beta|). \end{aligned}$$

注意, 当 $\beta=0$ 时上式不成立, 右端无意义, 左端的积分 $\int_0^{+\infty} \frac{\ln(\alpha^2 + x^2)}{x^2} dx$ 易知是发散的.

3801. $\int_0^{+\infty} \frac{\operatorname{arc} \operatorname{tg} \alpha x \cdot \operatorname{arc} \operatorname{tg} \beta x}{x^2} dx.$

解 先设 $\alpha \geq 0, \beta \geq 0$. 显然 $x=0$ 不是瑕点, 因为

$$\lim_{x \rightarrow +0} \frac{\operatorname{arc} \operatorname{tg} \alpha x \cdot \operatorname{arc} \operatorname{tg} \beta x}{x^2} = \alpha \beta.$$

由于当 $\alpha \geq 0, \beta \geq 0$ 时,

$$\left| \frac{\operatorname{arc\,tg} \alpha x \cdot \operatorname{arc\,tg} \beta x}{x^2} \right|$$

$$< \frac{\pi^2}{4} \cdot \frac{1}{x^2} \quad (1 \leq x < +\infty),$$

而积分 $\int_1^{+\infty} \frac{dx}{x^2}$ 收敛, 故积分

$\int_1^{+\infty} \frac{\operatorname{arc\,tg} \alpha x \cdot \operatorname{arc\,tg} \beta x}{x^2} dx$ 在 $\alpha \geq 0, \beta \geq 0$ 时一

致收敛, 从而积分 $\int_0^{+\infty} \frac{\operatorname{arc\,tg} \alpha x \cdot \operatorname{arc\,tg} \beta x}{x^2} dx$ 也

在 $\alpha \geq 0, \beta \geq 0$ 时一致收敛. 因此, 函数

$$I(\alpha, \beta) = \int_0^{+\infty} \frac{\operatorname{arc\,tg} \alpha x \cdot \operatorname{arc\,tg} \beta x}{x^2} dx$$

是 $\alpha \geq 0, \beta \geq 0$ 上的二元连续函数. 再考察两个积分

$$J(\alpha, \beta) = \int_0^{+\infty} \frac{\partial}{\partial \alpha} \left(\frac{\operatorname{arc\,tg} \alpha x \cdot \operatorname{arc\,tg} \beta x}{x^2} \right) dx$$

$$= \int_0^{+\infty} \frac{\operatorname{arc\,tg} \beta x}{x(1+\alpha^2 x^2)} dx,$$

$$K(\alpha, \beta) = \int_0^{+\infty} \frac{\partial}{\partial \beta} \left[\frac{\operatorname{arc\,tg} \beta x}{x(1+\alpha^2 x^2)} \right] dx$$

$$= \int_0^{+\infty} \frac{dx}{(1+\alpha^2 x^2)(1+\beta^2 x^2)}.$$

由于当 $\alpha \geq \alpha_0 > 0, \beta \geq 0$ 时 $\left| \frac{\operatorname{arc\,tg} \beta x}{x(1+\alpha^2 x^2)} \right| < \frac{\pi}{2}$

• $\frac{1}{x(1+\alpha_0^2 x^2)}$ ($1 \leq x < +\infty$), 而积分

$\int_1^{+\infty} \frac{dx}{x(1+\alpha_0^2 x^2)}$ 收敛, 故积分 $\int_1^{+\infty} \frac{\arctan \beta x}{x(1+\alpha^2 x^2)} dx$

当 $a \geq a_0, \beta \geq 0$ 时一致收敛, 从而积分

$\int_0^{+\infty} \frac{\arctan \beta x}{x(1+\alpha^2 x^2)} dx$ 当 $a \geq a_0, \beta \geq 0$ 时也一致收敛

(因为 $\lim_{x \rightarrow +0} \frac{\arctan \beta x}{x(1+\alpha^2 x^2)} = \beta$, 故 $x=0$ 不是瑕点).

因此, $J(a, \beta)$ 当 $a \geq a_0, \beta \geq 0$ 时连续, 并且此时 $J(a, \beta)$ 可在积分号下对 a 求导数, 得

$$J'_a(a, \beta) = \int_0^{+\infty} \frac{\arctan \beta x}{x(1+\alpha^2 x^2)} dx = J(a, \beta). \quad (1)$$

由 $a_0 > 0$ 的任意性知, (1) 式对一切 $a > 0, \beta \geq 0$ 成立; 并且 $J(a, \beta)$ 是 $a > 0, \beta \geq 0$ 上的二元连续函数.

其次, 由于当 $\beta \geq \beta_0 > 0, a > 0$ 时,

$$\begin{aligned} 0 &< \frac{1}{(1+\alpha^2 x^2)(1+\beta^2 x^2)} \\ &\leq \frac{1}{1+\beta_0^2 x^2} \quad (0 \leq x < +\infty). \end{aligned}$$

而积分 $\int_0^{+\infty} \frac{dx}{1+\beta_0^2 x^2}$ 收敛, 故积分

$$\int_0^{+\infty} \frac{dx}{(1+\alpha^2 x^2)(1+\beta^2 x^2)}$$

当 $\beta \geq \beta_0$, $\alpha > 0$ 时一致收敛. 因此, $K(\alpha, \beta)$ 是 $\alpha > 0$, $\beta \geq \beta_0$ 上的连续函数, 并且(1)式中的积分当 $\beta \geq \beta_0$ ($\alpha > 0$) 时可在积分号下对 β 求导数, 得

$$\begin{aligned}
 I''_{\alpha\beta}(\alpha, \beta) &= J'_\beta(\alpha, \beta) \\
 &= \int_0^{+\infty} \frac{dx}{(1+\alpha^2x^2)(1+\beta^2x^2)} \\
 &= \frac{\alpha^2}{\alpha^2-\beta^2} \int_0^{+\infty} \frac{dx}{1+\alpha^2x^2} \\
 &\quad - \frac{\beta^2}{\alpha^2-\beta^2} \int_0^{+\infty} \frac{dx}{1+\beta^2x^2} \\
 &= \frac{\alpha\pi}{2(\alpha^2-\beta^2)} - \frac{\beta\pi}{2(\alpha^2-\beta^2)} \\
 &= \frac{\pi}{2(\alpha+\beta)},
 \end{aligned}$$

由 $\beta_0 > 0$ 的任意性知, 对任何 $\alpha > 0$, $\beta > 0$ 均有

$$I''_{\alpha\beta}(\alpha, \beta) = J'_\beta(\alpha, \beta) = \frac{\pi}{2(\alpha+\beta)}. \quad (2)$$

(注意, 在推导此式时应设 $\alpha \neq \beta$, 因为推导过程中分母内有 $\alpha^2 - \beta^2$. 但由于 $K(\alpha, \beta)$ 是 $\alpha > 0$, $\beta > 0$ 上的连续函数, 故通过取极限即知(2)式当 $\alpha = \beta$ 时也成立). 在(2)式中固定 $\alpha > 0$, 对 β 积分, 得

$$\begin{aligned}
 I'_\alpha(\alpha, \beta) &= J(\alpha, \beta) \\
 &= \frac{\pi}{2} \ln(\alpha + \beta) + C(\alpha) \quad (0 < \beta < +\infty),
 \end{aligned}$$

其中 $C(\alpha)$ 是依赖于 α 的常数. 在此式中令 $\beta \rightarrow +0$, 并注意到 $J(\alpha, \beta)$ 在 $\alpha > 0$, $\beta \geq 0$ 上连续, 得

$$0 = J(a, 0) = \lim_{\beta \rightarrow +0} J(a, \beta) = \frac{\pi}{2} \ln a + C(a),$$

故

$$C(a) = -\frac{\pi}{2} \ln a.$$

因此,

$$I_1(a, \beta) = \frac{\pi}{2} \ln \frac{a+\beta}{a} \quad (a \geq 0, \beta > 0).$$

再固定 $\beta \geq 0$, 对 a 积分 (右端利用分部积分法), 得

$$I(a, \beta) = \frac{\pi}{2} a \ln \frac{a+\beta}{a} + \frac{\pi}{2} \beta \ln(a+\beta) + C^*(\beta),$$

其中 $C^*(\beta)$ 是依赖于 β 的常数. 在此式中令 $a \rightarrow +0$, 并注意到 $I(a, \beta)$ 在 $a \geq 0, \beta \geq 0$ 上连续, 得

$$\begin{aligned} 0 = I(0, \beta) &= \lim_{a \rightarrow +0} I(a, \beta) \\ &= \frac{\pi}{2} \beta \ln \beta + C^*(\beta), \end{aligned}$$

故

$$C^*(\beta) = -\frac{\pi}{2} \beta \ln \beta.$$

于是,

$$I(a, \beta) = \frac{\pi}{2} \ln \frac{(a+\beta)^{a+\beta}}{a^a \beta^\beta} \quad (a \geq 0, \beta > 0).$$

显然, 对于任何 α 与 β , 有

$$\int_0^{+\infty} \frac{\arctg \alpha x \cdot \arctg \beta x}{x^2} dx = \begin{cases} \operatorname{sgn}(\alpha\beta) \cdot \frac{\pi}{2} \ln \frac{(|\alpha| + |\beta|)^{|\alpha|+|\beta|}}{|\alpha|^{|\alpha|} \cdot |\beta|^{|\beta|}}, & \text{当 } \alpha\beta \neq 0 \text{ 时;} \\ 0, & \text{当 } \alpha\beta = 0 \text{ 时.} \end{cases}$$

3802. $\int_0^{+\infty} \frac{\ln(1+\alpha^2 x^2) \ln(1+\beta^2 x^2)}{x^4} dx.$

解 先设 $\alpha \geq 0, \beta \geq 0$. 首先, 注意, $x=0$ 不是瑕点, 因为

$$\lim_{x \rightarrow +0} \frac{\ln(1+\alpha^2 x^2) \ln(1+\beta^2 x^2)}{x^4} = \alpha^2 \beta^2.$$

由于当 $0 \leq \alpha \leq \alpha_1, 0 \leq \beta \leq \beta_1$ 时, 恒有

$$\begin{aligned} 0 &\leq \frac{\ln(1+\alpha^2 x^2) \ln(1+\beta^2 x^2)}{x^4} \\ &\leq \frac{\ln(1+\alpha_1^2 x^2) \ln(1+\beta_1^2 x^2)}{x^4}, \end{aligned}$$

而 $\int_0^{+\infty} \frac{\ln(1+\alpha_1^2 x^2) \ln(1+\beta_1^2 x^2)}{x^4} dx$ 收敛 (因为

$$\lim_{x \rightarrow +\infty} x^2 \cdot \frac{\ln(1+\alpha_1^2 x^2) \ln(1+\beta_1^2 x^2)}{x^4} = 0),$$

故积分 $\int_0^{+\infty} \frac{\ln(1+\alpha^2 x^2) \ln(1+\beta^2 x^2)}{x^4} dx$ 当 $0 \leq \alpha$

$\leq \alpha_1, 0 \leq \beta \leq \beta_1$ 时一致收敛. 因此, 函数

$$I(\alpha, \beta) = \int_0^{+\infty} \frac{\ln(1 + \alpha^2 x^2) \ln(1 + \beta^2 x^2)}{x^4} dx \quad (1)$$

是 $0 \leq \alpha \leq \alpha_1$, $0 \leq \beta \leq \beta_1$ 上的二元连续函数. 由 $\alpha_1 > 0$, $\beta_1 > 0$ 的任意性知, $I(\alpha, \beta)$ 是 $\alpha \geq 0$, $\beta \geq 0$ 上的二元连续函数. 再考察两个积分

$$\begin{aligned} J(\alpha, \beta) &= \int_0^{+\infty} \frac{\partial}{\partial \alpha} \left[\frac{\ln(1 + \alpha^2 x^2) \ln(1 + \beta^2 x^2)}{x^4} \right] dx \\ &= \int_0^{+\infty} \frac{2\alpha \ln(1 + \beta^2 x^2)}{x^2(1 + \alpha^2 x^2)} dx, \end{aligned} \quad (2)$$

$$\begin{aligned} K(\alpha, \beta) &= \int_0^{+\infty} \frac{\partial}{\partial \beta} \left[\frac{2\alpha \ln(1 + \beta^2 x^2)}{x^2(1 + \alpha^2 x^2)} \right] dx \\ &= \int_0^{+\infty} \frac{4\alpha\beta}{(1 + \alpha^2 x^2)(1 + \beta^2 x^2)} dx \\ &= \frac{2\pi\alpha\beta}{\alpha + \beta} \quad (\alpha > 0, \beta > 0). \end{aligned} \quad (3)$$

由于当 $0 < \alpha_0 \leq \alpha \leq \alpha_1$, $0 \leq \beta \leq \beta_1$ 时, 恒有

$$\begin{aligned} 0 &\leq \frac{2\alpha \ln(1 + \beta^2 x^2)}{x^2(1 + \alpha^2 x^2)} \\ &\leq \frac{2\alpha_1 \ln(1 + \beta_1^2 x^2)}{x^2(1 + \alpha_0^2 x^2)} \quad (0 < x < +\infty), \end{aligned}$$

而易知积分 $\int_0^{+\infty} \frac{2\alpha_1 \ln(1 + \beta_1^2 x^2)}{x^2(1 + \alpha_0^2 x^2)} dx$ 收敛, 故 (2)

式中的积分在 $0 < \alpha_0 \leq \alpha \leq \alpha_1$, $0 \leq \beta \leq \beta_1$ 上一致收敛. 由此可知 $J(\alpha, \beta)$ 是 $\alpha_0 \leq \alpha \leq \alpha_1$, $0 \leq \beta \leq \beta_1$ 上的连续函数, 并且在其上 (1) 中的积分可在积分号

下对 α 求导数, 得

$$\begin{aligned} I'_\alpha(\alpha, \beta) &= \int_0^{+\infty} \frac{2\alpha \ln(1+\beta^2 x^2)}{x^2(1+\alpha^2 x^2)} dx \\ &= J(\alpha, \beta). \end{aligned} \quad (4)$$

由 $\alpha_1 > \alpha_0 > 0$ 及 $\beta_1 > 0$ 的任意性知, $J(\alpha, \beta)$ 是 $\alpha > 0, \beta \geq 0$ 上的连续函数, 并且 (4) 式对一切 $\alpha > 0, \beta \geq 0$ 都成立.

其次, 当 $0 < \alpha \leq \alpha_1, 0 < \beta_0 \leq \beta \leq \beta_1$ 时, 恒有

$$\begin{aligned} 0 &< \frac{4\alpha\beta}{(1+\alpha^2 x^2)(1+\beta^2 x^2)} \\ &\leq \frac{4\alpha_1\beta_1}{1+\beta_0^2 x^2} \quad (0 < x < +\infty), \end{aligned}$$

而积分 $\int_0^{+\infty} \frac{4\alpha_1\beta_1}{1+\beta_0^2 x^2} dx$ 收敛, 故 (3) 式中的积

分在 $0 < \alpha \leq \alpha_1, 0 < \beta_0 \leq \beta \leq \beta_1$ 上一致收敛. 于是, 在其上 (2) 式中的积分可在积分号下对 β 求导数, 得

$$\begin{aligned} I''_{\alpha\beta}(\alpha, \beta) &= J'_\beta(\alpha, \beta) \\ &= \int_0^{+\infty} \frac{4\alpha\beta}{(1+\alpha^2 x^2)(1+\beta^2 x^2)} dx \\ &= \frac{2\pi\alpha\beta}{\alpha+\beta}. \end{aligned} \quad (5)$$

由 $\alpha_1 > 0, \beta_1 > \beta_0 > 0$ 的任意性知, (5) 式对一切 $\alpha > 0, \beta > 0$ 都成立. (5) 式两端对 β 积分之 ($\alpha > 0$ 固定), 得

$$\begin{aligned}
 I_0(a, \beta) &= J(a, \beta) \\
 &= 2\pi a\beta - 2\pi\alpha^2 \ln(a + \beta) + C(\alpha) \\
 &\quad (0 < \beta < +\infty),
 \end{aligned}$$

其中 $C(\alpha)$ 是依赖于 α 的常数。在此式中令 $\beta \rightarrow +0$ ，取极限，并注意到 $J(a, \beta)$ 在 $a > 0, \beta \geq 0$ 上连续，得

$$\begin{aligned}
 0 &= J(a, 0) = \lim_{\beta \rightarrow +0} J(a, \beta) \\
 &= -2\pi\alpha^2 \ln \alpha + C(\alpha),
 \end{aligned}$$

故

$$C(\alpha) = 2\pi\alpha^2 \ln \alpha.$$

因此，

$$\begin{aligned}
 I_0^*(a, \beta) &= 2\pi a\beta - 2\pi\alpha^2 \ln(a + \beta) + 2\pi\alpha^2 \ln \alpha \\
 &\quad (a > 0, \beta > 0).
 \end{aligned}$$

两端再对 a 积分 ($\beta > 0$ 固定)，得

$$\begin{aligned}
 I(a, \beta) &= \pi\alpha^2\beta - \frac{2}{3}\pi\alpha^3 \ln(a + \beta) \\
 &\quad + \frac{2\pi}{9}(a + \beta)^3 - \pi\alpha^2\beta \\
 &\quad - \frac{2}{3}\pi\beta^3 \ln(a + \beta) + \frac{2}{3}\pi\alpha^3 \ln \alpha \\
 &\quad - \frac{2\pi}{9}\alpha^3 + C^*(\beta) \quad (0 < a < +\infty),
 \end{aligned}$$

其中 $C^*(\beta)$ 是依赖于 β 的常数。在此式两端令 $a \rightarrow +0$ 取极限，并注意到 $I(a, \beta)$ 在 $a \geq 0, \beta \geq 0$ 上连续，得

$$\begin{aligned}
 0 &= I(0, \beta) = \lim_{\alpha \rightarrow +0} I(\alpha, \beta) \\
 &= \frac{2\pi}{9} \beta^3 - \frac{2}{3} \pi \beta^3 \ln \beta + C^*(\beta),
 \end{aligned}$$

故

$$C^*(\beta) = -\frac{2}{9} \pi \beta^3 + \frac{2}{3} \pi \beta^3 \ln \beta.$$

于是

$$\begin{aligned}
 I(\alpha, \beta) &= -\frac{2}{3} \pi (\alpha^3 + \beta^3) \ln(\alpha + \beta) \\
 &\quad + \frac{2\pi}{9} (\alpha + \beta)^3 - \frac{2\pi}{9} \alpha^3 \\
 &\quad - \frac{2}{9} \pi \beta^3 + \frac{2}{3} \pi (\alpha^3 \ln \alpha + \beta^3 \ln \beta) \\
 &= \frac{2\pi}{3} [\alpha\beta(\alpha + \beta) + \alpha^3 \ln \alpha + \beta^3 \ln \beta \\
 &\quad - (\alpha^3 + \beta^3) \ln(\alpha + \beta)] \quad (\alpha > 0, \beta > 0).
 \end{aligned}$$

因此, 对任意的 α, β 有

$$\begin{aligned}
 &\int_0^{+\infty} \frac{\ln(1 + \alpha^2 x^2) \ln(1 + \beta^2 x^2)}{x^4} dx \\
 &= \begin{cases} \frac{2\pi}{3} [|\alpha\beta| (|\alpha| + |\beta|) + |\alpha|^3 \ln|\alpha| \\ \quad + |\beta|^3 \ln|\beta| - (|\alpha|^3 + |\beta|^3) \ln(|\alpha| \\ \quad + |\beta|)], & \text{当 } \alpha\beta \neq 0 \text{ 时,} \\ 0, & \text{当 } \alpha\beta = 0 \text{ 时.} \end{cases}
 \end{aligned}$$

3803. 从公式

$$I^2 = \int_0^{+\infty} e^{-x^2} dx \int_0^{+\infty} x e^{-x^2 y^2} dy$$

出发, 计算尤拉-普阿桑积分

$$I = \int_0^{+\infty} e^{-x^2} dx.$$

解 在积分

$$I = \int_0^{+\infty} e^{-x^2} dx$$

中令 $x=ut$, 其中 u 为任意正数, 即得

$$I = u \int_0^{+\infty} e^{-u^2 t^2} dt.$$

在上式两端乘以 $e^{-u^2} du$, 再对 u 从 0 到 $+\infty$ 积分, 得

$$I^2 = \int_0^{+\infty} e^{-u^2} du \int_0^{+\infty} u e^{-u^2 t^2} dt. \quad (1)$$

由于被积函数 $u e^{-(1+t^2)u^2}$ 是非负连续函数, 并且积分

$$\int_0^{+\infty} e^{-(1+t^2)u^2} u du = \frac{1}{2(1+t^2)}$$

及

$$\int_0^{+\infty} e^{-(1+t^2)u^2} u dt = e^{-u^2} \cdot I$$

分别对于 t 及 u 是连续的, 积分互换后的逐次积分显然存在. 于是, (1) 式中的积分顺序可以互换*, 并且

有

$$\begin{aligned} I^2 &= \int_0^{+\infty} dt \int_0^{+\infty} e^{-(1+t^2)u^2} u du \\ &= \frac{1}{2} \int_0^{+\infty} \frac{dt}{1+t^2} = \frac{\pi}{4}. \end{aligned}$$

由于 $I > 0$, 故

$$I = \int_0^{+\infty} e^{-x^2} dx = \frac{\sqrt{\pi}}{2}.$$

*) 参看菲赫金哥尔茨著《微积分学教程》第二卷 483目定理 V 的系理.

利用尤拉-普阿桑积分, 求下列积分之值:

3804. $\int_{-\infty}^{+\infty} e^{-(ax^2+2bx+c)} dx \quad (a > 0, ac - b^2 > 0)^{*})$.

$$\begin{aligned} \text{解} \quad & \int_{-\infty}^{+\infty} e^{-(ax^2+2bx+c)} dx \\ &= \int_{-\infty}^{+\infty} e^{-\frac{1}{a}[(ax+b)^2+ac-b^2]} dx \\ &= e^{\frac{b^2-ac}{a}} \int_{-\infty}^{+\infty} e^{-\frac{1}{a}(ax+b)^2} dx \\ &= e^{\frac{b^2-ac}{a}} \int_{-\infty}^{+\infty} \frac{1}{\sqrt{a}} e^{-t^2} dt \\ &= \frac{2}{\sqrt{a}} e^{\frac{b^2-ac}{a}} \int_0^{+\infty} e^{-t^2} dt \end{aligned}$$

$$\begin{aligned}
&= \frac{2}{\sqrt{a}} e^{\frac{b^2-ac}{a}} \cdot \frac{\sqrt{\pi}}{2} \\
&= \sqrt{\frac{\pi}{a}} e^{\frac{b^2-ac}{a}}.
\end{aligned}$$

*) 只要假定 $a > 0$, 条件 $ac - b^2 > 0$ 可去掉.

3805. $\int_{-\infty}^{+\infty} (a_1 x^2 + 2b_1 x + c_1) e^{-(ax^2 + 2bx + c)} dx$
 $(a > 0, ac - b^2 > 0)$ *).

解 设 $\frac{1}{\sqrt{a}}(ax + b) = t$, 则 $x = \frac{\sqrt{a}t - b}{a}$. 代入
得

$$\begin{aligned}
&\int_{-\infty}^{+\infty} (a_1 x^2 + 2b_1 x + c_1) e^{-(ax^2 + 2bx + c)} dx \\
&= \frac{1}{\sqrt{a}} e^{\frac{b^2-ac}{a}} \int_{-\infty}^{+\infty} \left[\frac{a_1}{a} t^2 + \frac{2(ab_1 - a_1 b)}{a\sqrt{a}} t \right. \\
&\quad \left. + \frac{a_1 b^2 - 2abb_1 + c_1}{a^2} \right] e^{-t^2} dt.
\end{aligned}$$

由于

$$\begin{aligned}
&\int_{-\infty}^{+\infty} t^2 e^{-t^2} dt = -\frac{1}{2} \int_{-\infty}^{+\infty} t d(e^{-t^2}) \\
&= -\frac{1}{2} t e^{-t^2} \Big|_{-\infty}^{+\infty} + \frac{1}{2} \int_{-\infty}^{+\infty} e^{-t^2} dt = \frac{\sqrt{\pi}}{2}, \\
&\int_{-\infty}^{+\infty} t e^{-t^2} dt = 0
\end{aligned}$$

及

$$\int_{-\infty}^{+\infty} e^{-t^2} dt = 2 \int_0^{+\infty} e^{-t^2} dt = \sqrt{\pi},$$

故得

$$\begin{aligned} & \int_{-\infty}^{+\infty} (a_1 x^2 + 2b_1 x + c_1) e^{-(ax^2 + 2bx + c)} dx \\ &= \frac{1}{\sqrt{a}} e^{\frac{b^2 - ac}{a}} \left[\frac{a_1}{a} \cdot \frac{\sqrt{\pi}}{2} \right. \\ & \quad \left. + \left(\frac{a_1 b^2 - 2abb_1}{a^2} + c_1 \right) \sqrt{\pi} \right] \\ &= \frac{(a + 2b^2)a_1 - 4abb_1 + 2a^2c_1}{2a^2} \\ & \quad \cdot \sqrt{\frac{\pi}{a}} e^{\frac{b^2 - ac}{a}}. \end{aligned}$$

*) 只要假定 $a > 0$, 条件 $ac - b^2 > 0$ 可去掉.

3806. $\int_{-\infty}^{+\infty} e^{-ax^2} \operatorname{ch} bx dx \quad (a > 0).$

解 $\int_{-\infty}^{+\infty} e^{-ax^2} \operatorname{ch} bx dx$

$$= \frac{1}{2} \int_{-\infty}^{+\infty} e^{-ax^2} (e^{bx} + e^{-bx}) dx$$

$$= \frac{1}{2} \int_{-\infty}^{+\infty} e^{-(ax^2 - bx)} dx + \frac{1}{2} \int_{-\infty}^{+\infty} e^{-(ax^2 + bx)} dx$$

$$= \frac{1}{2} \sqrt{\frac{\pi}{a}} e^{\frac{b^2}{4a}} + \frac{1}{2} \sqrt{\frac{\pi}{a}} e^{\frac{b^2}{4a}} \quad *)$$

$$= \sqrt{\frac{\pi}{a}} e^{\frac{b^2}{4a}}.$$

*) 利用3804题的结果.

$$3807. \int_0^{+\infty} e^{-\left(x^2 + \frac{a^2}{x^2}\right)} dx \quad (a > 0).$$

解 由于积分

$$\int_0^{+\infty} e^{-x^2} dx = \frac{\sqrt{\pi}}{2},$$

故利用2355题的结果, 即得

$$\begin{aligned} & \int_0^{+\infty} e^{-\left(x^2 + \frac{a^2}{x^2}\right)} dx \\ &= e^{2a} \int_0^{+\infty} e^{-\left(x + \frac{a}{x}\right)^2} dx \\ &= e^{2a} \int_0^{+\infty} e^{-(x^2 + 4a)} dx \\ &= e^{-2a} \int_0^{+\infty} e^{-x^2} dx = \frac{\sqrt{\pi}}{2} e^{-2a}. \end{aligned}$$

$$3808. \int_0^{+\infty} \frac{e^{-\alpha x^2} - e^{-\beta x^2}}{x^2} dx \quad (\alpha > 0, \beta > 0).$$

解 由分部积分法知

$$\begin{aligned} & \int_0^{+\infty} \frac{e^{-\alpha x^2} - e^{-\beta x^2}}{x^2} dx \\ &= - \int_0^{+\infty} (e^{-\alpha x^2} - e^{-\beta x^2}) d\left(\frac{1}{x}\right) \end{aligned}$$

$$\begin{aligned}
&= -\frac{e^{-ax^2} - e^{-\beta x^2}}{x} \Big|_0^{+\infty} \\
&\quad - 2 \int_0^{+\infty} (\alpha e^{-ax^2} - \beta e^{-\beta x^2}) dx \\
&= -2 \int_0^{+\infty} \sqrt{\alpha} e^{-(\sqrt{\alpha}x)^2} d(\sqrt{\alpha}x) \\
&\quad + 2 \int_0^{+\infty} \sqrt{\beta} e^{-(\sqrt{\beta}x)^2} d(\sqrt{\beta}x) \\
&= -2\sqrt{\alpha} \cdot \frac{\sqrt{\pi}}{2} + 2\sqrt{\beta} \cdot \frac{\sqrt{\pi}}{2} \\
&= \sqrt{\pi}(\sqrt{\beta} - \sqrt{\alpha}).
\end{aligned}$$

3809. $\int_0^{+\infty} e^{-ax^2} \cos bx \, dx \quad (a > 0)$.

解 令 $I(b) = \int_0^{+\infty} e^{-ax^2} \cos bx \, dx$. 由于 $e^{-ax^2} \cos bx$

与 $\frac{\partial}{\partial b}(e^{-ax^2} \cos bx) = -x e^{-ax^2} \sin bx$ 都是 $x \geq 0$,

$-\infty < b < +\infty$ 上的连续函数, 并且此时

$$|e^{-ax^2} \cos bx| \leq e^{-ax^2},$$

$$|x e^{-ax^2} \sin bx| \leq x e^{-ax^2},$$

而积分 $\int_0^{+\infty} e^{-ax^2} dx$ 与 $\int_0^{+\infty} x e^{-ax^2} dx$ 都收敛, 故积

分 $\int_0^{+\infty} e^{-ax^2} \cos bx \, dx$ 与 $\int_0^{+\infty} x e^{-ax^2} \sin bx \, dx$ 都在

$-\infty < b < +\infty$ 上一致收敛, 从而可在积分号下求导

数, 得

$$I'(b) = - \int_0^{+\infty} x e^{-ax^2} \sin bx \, dx$$

($-\infty < b < +\infty$).

利用分部积分法, 得

$$\begin{aligned} & \int_0^{+\infty} x e^{-ax^2} \sin bx \, dx \\ &= -\frac{1}{2a} e^{-ax^2} \sin bx \Big|_0^{+\infty} \\ & \quad + \frac{b}{2a} \int_0^{+\infty} e^{-ax^2} \cos bx \, dx \\ &= -\frac{b}{2a} I(b), \end{aligned}$$

故 $I'(b) = -\frac{b}{2a} I(b)$ ($-\infty < b < +\infty$).

于是,

$$\int \frac{I'(b)}{I(b)} \, db = -\frac{1}{2a} \int b \, db,$$

即

$$\ln I(b) = -\frac{b^2}{4a} + C \quad (-\infty < b < +\infty),$$

其中 C 是待定常数, 也即

$$I(b) = C_1 e^{-\frac{b^2}{4a}} \quad (-\infty < b < +\infty),$$

其中 C_1 也是待定常数. 但

$$\begin{aligned}
 I(0) &= \int_0^{+\infty} e^{-ax^2} dx \\
 &= \frac{1}{\sqrt{a}} \int_0^{+\infty} e^{-t^2} dt = \frac{1}{2} \sqrt{\frac{\pi}{a}},
 \end{aligned}$$

代入, 得 $C_1 = \frac{1}{2} \sqrt{\frac{\pi}{a}}$. 于是, 最后得

$$\begin{aligned}
 &\int_0^{+\infty} e^{-ax^2} \cos bx dx \\
 &= I(b) = \frac{1}{2} \sqrt{\frac{\pi}{a}} e^{-\frac{b^2}{4a}} \quad (-\infty < b < +\infty).
 \end{aligned}$$

3810. $\int_0^{+\infty} x e^{-ax^2} \sin bx dx \quad (a > 0)$.

$$\begin{aligned}
 \text{解} \quad &\int_0^{+\infty} x e^{-ax^2} \sin bx dx \\
 &= -\frac{1}{2a} \int_0^{+\infty} \sin bx d(e^{-ax^2}) \\
 &= -\frac{1}{2a} e^{-ax^2} \sin bx \Big|_0^{+\infty} \\
 &\quad + \frac{b}{2a} \int_0^{+\infty} e^{-ax^2} \cos bx dx \\
 &= \frac{b}{2a} \int_0^{+\infty} e^{-ax^2} \cos bx dx \\
 &= \frac{b}{4a} \sqrt{\frac{\pi}{a}} e^{-\frac{b^2}{4a}} \quad *)
 \end{aligned}$$

*) 利用3809题的结果.

$$3811. \int_0^{+\infty} x^{2n} e^{-x^2} \cos 2bx \, dx \quad (n \text{ 为自然数}).$$

解 由3809题得

$$\int_0^{+\infty} e^{-x^2} \cos 2bx \, dx = \frac{\sqrt{\pi}}{2} e^{-b^2}. \quad (1)$$

$$\begin{aligned} \text{积分} \quad & \int_0^{+\infty} \frac{\partial^k}{\partial b^k} (e^{-x^2} \cos 2bx) \, dx \\ & = 2^k \int_0^{+\infty} x^k e^{-x^2} \cos \left(2bx + \frac{k\pi}{2} \right) \, dx, \quad (2) \end{aligned}$$

$$\text{而} \left| x^k e^{-x^2} \cos \left(2bx + \frac{k\pi}{2} \right) \right| \leq x^k e^{-x^2} \quad (x \geq 0).$$

但是积分 $\int_0^{+\infty} x^k e^{-x^2} \, dx$ 对于任意的自然数 k 均收敛, 故积分 (2) 当 $-\infty < b < +\infty$ 时一致收敛. 因此, (1) 式的左端可在积分号下求任意次导数, 从而可得

$$\begin{aligned} & \int_0^{+\infty} \frac{\partial^{2n}}{\partial b^{2n}} (e^{-x^2} \cos 2bx) \, dx \\ & = \int_0^{+\infty} 2^{2n} x^{2n} e^{-x^2} \cos(2bx + n\pi) \, dx \\ & = 2^{2n} (-1)^n \int_0^{+\infty} x^{2n} e^{-x^2} \cos 2bx \, dx \\ & = \frac{\sqrt{\pi}}{2} \frac{d^{2n}}{db^{2n}} (e^{-b^2}), \end{aligned}$$

即

$$\int_0^{+\infty} x^{2n} e^{-x^2} \cos 2bx \, dx$$

$$= (-1)^n \cdot \frac{\sqrt{\pi}}{2^{2n+1}} \frac{d^{2n}}{db^{2n}} (e^{-b^2}).$$

3812. 从积分

$$I(a) = \int_0^{+\infty} e^{-ax} \frac{\sin \beta x}{x} dx$$

出发, 计算迪里黑里积分

$$D(\beta) = \int_0^{+\infty} \frac{\sin \beta x}{x} dx.$$

解 先设 $\beta > 0$. 将 β 固定, α 视为参变量. 仿 3760 题的证法, 可知积分 $\int_0^{+\infty} e^{-ax} \frac{\sin \beta x}{x} dx$ 当 $a \geq 0$ 时一致收敛, 从而 $I(a)$ 是 $a \geq 0$ 上的连续函数 (注意, 上述积分中 $x=0$ 不是瑕点, 因为 $\lim_{x \rightarrow +0} e^{-ax} \frac{\sin \beta x}{x} = \beta$). 由于

$$\int_0^{+\infty} \frac{\partial}{\partial a} \left(e^{-ax} \frac{\sin \beta x}{x} \right) dx$$

$$= - \int_0^{+\infty} e^{-ax} \sin \beta x \, dx = - \frac{\beta}{a^2 + \beta^2},$$

易知积分 $\int_0^{+\infty} e^{-ax} \sin \beta x \, dx$ 当 $a \geq a_0 > 0$ 时一致收

敛 (因为此时 $|e^{-ax} \sin \beta x| \leq e^{-a_0 x}$, 而 $\int_0^{+\infty} e^{-a_0 x} dx$

收敛)，故知当 $a \geq a_0$ 时，积分 $\int_0^{+\infty} e^{-ax} \frac{\sin \beta x}{x} dx$ 可在积分号下求导数，得

$$I'(a) = -\frac{\beta}{a^2 + \beta^2}.$$

由 $a_0 > 0$ 的任意性知，上式对一切 $0 < a < +\infty$ 皆成立。两端对 a 积分，得

$$I(a) = -\operatorname{arc} \operatorname{tg} \frac{a}{\beta} + C \quad (0 < a < +\infty), \quad (1)$$

其中 C 是某常数。由 $|\sin u| \leq |u|$ 知

$$|I(a)| \leq \beta \int_0^{+\infty} e^{-ax} dx = \frac{\beta}{a} \quad (0 < a < +\infty),$$

由此可知 $\lim_{a \rightarrow +\infty} I(a) = 0$ 。在 (1) 式两端令 $a \rightarrow +\infty$

取极限，得 $0 = -\frac{\pi}{2} + C$ ，故 $C = \frac{\pi}{2}$ 。于是，

$$I(a) = -\operatorname{arc} \operatorname{tg} \frac{a}{\beta} + \frac{\pi}{2} \quad (0 < a < +\infty). \quad (2)$$

在 (2) 式两端令 $a \rightarrow +0$ 取极限，并注意到 $I(a)$ 当 $a \geq 0$ 时连续，即得

$$D(\beta) = I(0) = \lim_{a \rightarrow +0} I(a) = \frac{\pi}{2}.$$

当 $\beta < 0$ 时， $D(\beta) = -D(-\beta) = -\frac{\pi}{2}$ 。又显然有

$D(0) = 0$ 。综上所述，有

$$D(\beta) = \frac{\pi}{2} \operatorname{sgn} \beta.$$

利用迪里黑里和傅茹兰积分, 求下列积分之值:

$$3813. \int_0^{+\infty} \frac{e^{-ax^2} - \cos \beta x}{x^2} dx \quad (a > 0).$$

解 令 $I(\beta) = \int_0^{+\infty} \frac{e^{-ax^2} - \cos \beta x}{x^2} dx$. 首先注意到

$x = 0$ 不是瑕点, 因为

$$\begin{aligned} & \lim_{x \rightarrow 0} \frac{e^{-ax^2} - \cos \beta x}{x^2} \\ &= \lim_{x \rightarrow 0} \frac{-2axe^{-ax^2} + \beta \sin \beta x}{2x} = \frac{\beta^2}{2} - a. \end{aligned}$$

由于

$$\left| \frac{e^{-ax^2} - \cos \beta x}{x^2} \right| \leq \frac{2}{x^2} \quad (x > 0),$$

而 $\int_1^{+\infty} \frac{dx}{x^2}$ 收敛, 故 $\int_1^{+\infty} \frac{e^{-ax^2} - \cos \beta x}{x^2} dx$ 在 $-\infty$

$< \beta < +\infty$ 上一致收敛, 从而 $\int_0^{+\infty} \frac{e^{-ax^2} - \cos \beta x}{x^2} dx$

也在 $-\infty < \beta < +\infty$ 上一致收敛. 于是, $I(\beta)$ 是 $-\infty < \beta < +\infty$ 上的连续函数. 下设 $\beta > 0$. 由于

$$\begin{aligned} & \int_0^{+\infty} \frac{\partial}{\partial \beta} \left(\frac{e^{-ax^2} - \cos \beta x}{x^2} \right) dx \\ &= \int_0^{+\infty} \frac{\sin \beta x}{x} dx = \frac{\pi}{2}, \end{aligned}$$

而积分 $\int_0^{+\infty} \frac{\sin \beta x}{x} dx$ 在 $\beta \geq \beta_0 > 0$ 上一致收敛

(因为当 $x \rightarrow +\infty$ 时 $\frac{1}{x}$ 单调递减趋于零, 而

$$\left| \int_0^A \sin \beta x dx \right| = \left| \frac{1 - \cos \beta A}{\beta} \right| \leq \frac{2}{\beta_0},$$
 故由迪里

黑里判别法知 $\int_0^{+\infty} \frac{\sin \beta x}{x} dx$ 当 $\beta \geq \beta_0$ 时一致收敛)。于是, 当 $\beta \geq \beta_0$ 时, 可在积分号下求导数, 得

$$I'(\beta) = \int_0^{+\infty} \frac{\sin \beta x}{x} dx = \frac{\pi}{2}. \quad (*) \quad (1)$$

由 $\beta_0 > 0$ 的任意性知, (1) 式对一切 $\beta > 0$ 皆成立。于是

$$I(\beta) = \frac{\pi}{2} \beta + C \quad (0 < \beta < +\infty), \quad (2)$$

其中 C 是某常数。在 (2) 式两端令 $\beta \rightarrow +0$ 取极限, 并注意到 $I(\beta)$ 在 $-\infty < \beta < +\infty$ 上的连续性, 得

$$\int_0^{+\infty} \frac{e^{-ax^2} - 1}{x^2} dx = I(0) = \lim_{\beta \rightarrow +0} I(\beta) = C. \quad (3)$$

根据3808题结果知

$$\begin{aligned} & \int_0^{+\infty} \frac{e^{-ax^2} - e^{-\beta x^2}}{x^2} dx \\ &= \sqrt{\pi} (\sqrt{\beta} - \sqrt{a}) \quad (a > 0, \beta > 0). \end{aligned} \quad (4)$$

令 $J(\beta) = \int_0^{+\infty} \frac{e^{-ax^2} - e^{-\beta x^2}}{x^2} dx \quad (a > 0)$, 仿上

面之证, 易知 $\int_0^{+\infty} \frac{e^{-ax^2} - e^{-\beta x^2}}{x^2} dx$ 当 $\beta \geq 0$ 时一致收敛, 故 $J(\beta)$ 是 $\beta \geq 0$ 上的连续函数. 于是, 在 (4) 式两端令 $\beta \rightarrow +0$ 取极限, 得

$$\begin{aligned} \int_0^{+\infty} \frac{e^{-ax^2} - 1}{x^2} dx &= J(0) \\ &= \lim_{\beta \rightarrow +0} J(\beta) = -\sqrt{\pi a} \quad (a > 0), \end{aligned}$$

以此代入 (3) 式, 得 $C = -\sqrt{\pi a}$. 于是,

$$I(\beta) = \frac{\pi}{2} \beta - \sqrt{\pi a} \quad (0 \leq \beta < +\infty).$$

当 $\beta < 0$ 时, $I(\beta) = I(-\beta) = \frac{\pi}{2} (-\beta) - \sqrt{\pi a}$.

总之, 得

$$\begin{aligned} \int_0^{+\infty} \frac{e^{-ax^2} - \cos \beta x}{x^2} dx \\ = \frac{\pi}{2} |\beta| - \sqrt{\pi a} \quad (a > 0). \end{aligned}$$

*) 利用 3812 题的结果.

$$3814. \int_0^{+\infty} \frac{\sin \alpha x \sin \beta x}{x} dx.$$

$$\begin{aligned} \text{解} \quad & \int_0^{+\infty} \frac{\sin \alpha x \sin \beta x}{x} dx \\ &= \frac{1}{2} \int_0^{+\infty} \frac{\cos(\alpha - \beta)x - \cos(\alpha + \beta)x}{x} dx \end{aligned}$$

$$= \frac{1}{2} \ln \left| \frac{\alpha + \beta}{\alpha - \beta} \right| \quad *)$$

*) 利用3790题的结果.

$$3815. \int_0^{+\infty} \frac{\sin \alpha x \cos \beta x}{x} dx.$$

$$\begin{aligned} \text{解} \quad & \int_0^{+\infty} \frac{\sin \alpha x \cos \beta x}{x} dx \\ &= \frac{1}{2} \int_0^{+\infty} \frac{\sin(\alpha + \beta)x + \sin(\alpha - \beta)x}{x} dx \\ &= \frac{1}{2} \int_0^{+\infty} \frac{\sin(\alpha + \beta)x - \sin(\beta - \alpha)x}{x} dx \\ &= \begin{cases} 0, & \text{若 } |\alpha| < |\beta| \quad *), \\ \frac{\pi}{4} \operatorname{sgn} \alpha, & \text{若 } |\alpha| = |\beta| \quad **), \\ \frac{\pi}{2} \operatorname{sgn} \alpha, & \text{若 } |\alpha| > |\beta| \quad ***). \end{cases} \end{aligned}$$

*) 利用3791题的结果.

***) 及 ***) 利用3812题的结果.

$$3816. \int_0^{+\infty} \frac{\sin^3 \alpha x}{x} dx$$

解 由于 $\sin 3\alpha x = 3 \sin \alpha x - 4 \sin^3 \alpha x$, 故

$$\begin{aligned} \int_0^{+\infty} \frac{\sin^3 \alpha x}{x} dx &= \int_0^{+\infty} \frac{3 \sin \alpha x - \sin 3\alpha x}{4x} dx \\ &= \frac{\pi}{2} \operatorname{sgn} \alpha \cdot \left(\frac{3}{4} - \frac{1}{4} \right) \quad *) = \frac{\pi}{4} \operatorname{sgn} \alpha. \end{aligned}$$

*) 利用3812题的结果.

$$3817. \int_0^{+\infty} \left(\frac{\sin \alpha x}{x} \right)^2 dx.$$

解 令 $I(\alpha) = \int_0^{+\infty} \left(\frac{\sin \alpha x}{x} \right)^2 dx$. 先设 $\alpha \geq 0$.

显然 $x=0$ 不是瑕点, 因为 $\lim_{x \rightarrow +0} \left(\frac{\sin \alpha x}{x} \right)^2 = \alpha^2$.

而由于 $\left(\frac{\sin \alpha x}{x} \right)^2 \leq \frac{1}{x^2}$, 又 $\int_1^{+\infty} \frac{dx}{x^2}$ 收敛, 故

$\int_1^{+\infty} \left(\frac{\sin \alpha x}{x} \right)^2 dx$ 在 $\alpha \geq 0$ 上一致收敛, 从而

$\int_0^{+\infty} \left(\frac{\sin \alpha x}{x} \right)^2 dx$ 在 $\alpha \geq 0$ 时一致收敛. 因此, $I(\alpha)$

是 $\alpha \geq 0$ 上的连续函数.

又因

$$\begin{aligned} & \int_0^{+\infty} \frac{\partial}{\partial \alpha} \left(\frac{\sin \alpha x}{x} \right)^2 dx \\ &= \int_0^{+\infty} \frac{\sin 2\alpha x}{x} dx = \frac{\pi}{2}, \end{aligned}$$

而积分 $\int_0^{+\infty} \frac{\sin 2\alpha x}{x} dx$ 当 $\alpha \geq \alpha_0 > 0$ 时一致收敛

(参看3813题的解题过程), 故当 $\alpha \geq \alpha_0$ 时可在积分号下求导数, 得

$$I'(\alpha) = \int_0^{+\infty} \frac{\sin 2\alpha x}{x} dx = \frac{\pi}{2}, \quad (1)$$

由 $\alpha_0 > 0$ 的任意性知, (1) 式对一切 $\alpha > 0$ 皆成立. 两端积分, 得

$$I(\alpha) = \frac{\pi}{2} \alpha + C \quad (0 < \alpha < +\infty),$$

其中 C 是某常数. 在上式两端令 $\alpha \rightarrow +0$ 取极限, 并注意到 $I(\alpha)$ 在 $\alpha \geq 0$ 时的连续性知

$$0 = I(0) = \lim_{\alpha \rightarrow +0} I(\alpha) = C.$$

于是 $I(\alpha) = \frac{\pi}{2} \alpha$ ($0 \leq \alpha < +\infty$). 当 $\alpha < 0$ 时, 显

然, $I(\alpha) = I(-\alpha) = \frac{\pi}{2}(-\alpha)$, 故对于任何 α , 有

$$\int_0^{+\infty} \left(\frac{\sin \alpha x}{x} \right)^2 dx = I(\alpha) = \frac{\pi}{2} |\alpha|.$$

3818. $\int_0^{+\infty} \left(\frac{\sin \alpha x}{x} \right)^3 dx.$

解 $\int_0^{+\infty} \left(\frac{\sin \alpha x}{x} \right)^3 dx$

$$= -\frac{1}{2} \int_0^{+\infty} \sin^3 \alpha x \, d\left(\frac{1}{x^2}\right)$$

$$= -\frac{1}{2x^2} \sin^3 \alpha x \Big|_0^{+\infty}$$

$$+ \frac{1}{2} \int_0^{+\infty} \frac{3\alpha \sin^2 \alpha x \cos \alpha x}{x^2} dx$$

$$= \frac{3\alpha}{2} \int_0^{+\infty} \frac{\sin^2 \alpha x \cos \alpha x}{x^2} dx$$

$$\begin{aligned}
&= -\frac{3\alpha}{2} \int_0^{+\infty} \sin^2 \alpha x \cos \alpha x d\left(\frac{1}{x}\right) \\
&= -\frac{3\alpha}{2x} \sin^2 \alpha x \cos \alpha x \Big|_0^{+\infty} \\
&\quad + \frac{3\alpha}{2} \int_0^{+\infty} \frac{2\alpha \sin \alpha x \cos^2 \alpha x - \alpha \sin^3 \alpha x}{x} dx \\
&= \frac{3\alpha}{2} \int_0^{+\infty} \frac{2\alpha \sin \alpha x}{x} dx \\
&\quad - \frac{3\alpha}{2} \int_0^{+\infty} \frac{3\alpha \sin^3 \alpha x}{x} dx \\
&= 3\alpha^2 \cdot \frac{\pi}{2} \operatorname{sgn} \alpha - \frac{9}{2} \alpha^2 \cdot \frac{\pi}{4} \operatorname{sgn} \alpha \quad *) \\
&= \frac{3\pi}{8} \alpha^2 \operatorname{sgn} \alpha = \frac{3\pi}{8} \alpha |\alpha|.
\end{aligned}$$

*) 利用3816题的结果。

3819. $\int_0^{+\infty} \frac{\sin^4 x}{x^2} dx.$

解 $\int_0^{+\infty} \frac{\sin^4 x}{x^2} dx$

$$\begin{aligned}
&= -\frac{1}{x} \sin^4 x \Big|_0^{+\infty} + \int_0^{+\infty} \frac{4 \sin^3 x \cos x}{x} dx \\
&= \int_0^{+\infty} \frac{(3 \sin x - \sin 3x) \cos x}{x} dx \\
&= \frac{3}{2} \int_0^{+\infty} \frac{\sin 2x}{x} dx - \frac{1}{2} \int_0^{+\infty} \frac{\sin 4x}{x} dx
\end{aligned}$$

$$\begin{aligned}
 & -\frac{1}{2} \int_0^{+\infty} \frac{\sin 2x}{x} dx \\
 & = \left(\frac{3}{2} - \frac{1}{2} - \frac{1}{2} \right) \frac{\pi}{2} = \frac{\pi}{4}.
 \end{aligned}$$

3820. $\int_0^{+\infty} \frac{\sin^4 \alpha x - \sin^4 \beta x}{x} dx.$

解 由于 $\sin^4 x = \frac{1}{8}(\cos 4x - 4 \cos 2x + 3)$, 故

$$\begin{aligned}
 & \int_0^{+\infty} \frac{\sin^4 \alpha x - \sin^4 \beta x}{x} dx \\
 & = \frac{1}{8} \int_0^{+\infty} \frac{\cos 4 \alpha x - \cos 4 \beta x}{x} dx \\
 & \quad - \frac{1}{2} \int_0^{+\infty} \frac{\cos 2 \alpha x - \cos 2 \beta x}{x} dx \\
 & = \frac{1}{8} \ln \left| \frac{\beta}{\alpha} \right| - \frac{1}{2} \ln \left| \frac{\beta}{\alpha} \right| \\
 & = \frac{3}{8} \ln \left| \frac{\alpha}{\beta} \right| \quad (\alpha \neq 0, \beta \neq 0).
 \end{aligned}$$

注 若 $\alpha = \beta = 0$, 显然积分为零; 若 $\alpha = 0 (\beta \neq 0)$ 或 $\beta = 0 (\alpha \neq 0)$, 易知积分发散.

3821. $\int_0^{+\infty} \frac{\sin(x^2)}{x} dx.$

解 作代换 $x = \sqrt{t}$, 则有

$$\int_0^{+\infty} \frac{\sin(x^2)}{x} dx = \frac{1}{2} \int_0^{+\infty} \frac{\sin t}{t} dt = \frac{\pi}{4}.$$

$$3822. \int_0^{+\infty} e^{-kx} \frac{\sin ax \sin \beta x}{x^2} dx \quad (k \geq 0, a > 0, \beta > 0).$$

$$\begin{aligned} \text{解} \quad & \int_0^{+\infty} e^{-kx} \frac{\sin ax \sin \beta x}{x^2} dx \\ &= -\frac{1}{x} e^{-kx} \sin ax \sin \beta x \Big|_0^{+\infty} \\ &+ \int_0^{+\infty} \frac{1}{x} \{ -ke^{-kx} \sin ax \sin \beta x \\ &+ e^{-kx} (a \sin \beta x \cos ax + \beta \sin ax \cos \beta x) \} dx \\ &= \int_0^{+\infty} e^{-kx} \frac{a \sin \beta x \cos ax + \beta \sin ax \cos \beta x}{x} dx \\ &- k \int_0^{+\infty} e^{-kx} \frac{\sin ax \sin \beta x}{x} dx. \end{aligned}$$

由于

$$\begin{aligned} & \int_0^{+\infty} e^{-kx} \frac{a \sin \beta x \cos ax}{x} dx \\ &= \frac{a}{2} \int_0^{+\infty} e^{-kx} \frac{\sin(a+\beta)x - \sin(a-\beta)x}{x} dx \\ &= \frac{a}{2} \left(\operatorname{arc} \operatorname{tg} \frac{a+\beta}{k} - \operatorname{arc} \operatorname{tg} \frac{a-\beta}{k} \right)^*, \\ & \int_0^{+\infty} e^{-kx} \frac{\beta \sin ax \cos \beta x}{x} dx \\ &= \frac{\beta}{2} \left(\operatorname{arc} \operatorname{tg} \frac{a+\beta}{k} + \operatorname{arc} \operatorname{tg} \frac{a-\beta}{k} \right), \end{aligned}$$

且

$$\begin{aligned}
& \int_0^{+\infty} e^{-kx} \frac{\sin \alpha x \sin \beta x}{x} dx \\
&= \int_0^{+\infty} \frac{[(e^{-kx}-1)+1] \cdot [\cos(\alpha-\beta)x - \cos(\alpha+\beta)x]}{2x} dx \\
&= \frac{1}{2} \int_0^{+\infty} (e^{-kx} - 1) \frac{\cos(\alpha-\beta)x}{x} dx \\
&\quad - \frac{1}{2} \int_0^{+\infty} (e^{-kx} - 1) \frac{\cos(\alpha+\beta)x}{x} dx \\
&\quad + \frac{1}{2} \int_0^{+\infty} \frac{\cos(\alpha-\beta)x - \cos(\alpha+\beta)x}{x} dx \\
&= \frac{1}{2} \cdot \frac{1}{2} \ln \frac{(\alpha-\beta)^2}{(\alpha-\beta)^2 + k^2} \\
&\quad - \frac{1}{2} \cdot \frac{1}{2} \ln \frac{(\alpha+\beta)^2}{(\alpha+\beta)^2 + k^2}^{**}) + \frac{1}{2} \ln \left| \frac{\alpha+\beta}{\alpha-\beta} \right| \\
&= \frac{1}{4} \ln \frac{(\alpha+\beta)^2 + k^2}{(\alpha-\beta)^2 + k^2},
\end{aligned}$$

故

$$\begin{aligned}
& \int_0^{+\infty} e^{-kx} \frac{\sin \alpha x \sin \beta x}{x^2} dx \\
&= \frac{\alpha+\beta}{2} \operatorname{arc} \operatorname{tg} \frac{\alpha+\beta}{k} - \frac{\alpha-\beta}{2} \operatorname{arc} \operatorname{tg} \frac{\alpha-\beta}{k} \\
&\quad + \frac{k}{4} \ln \frac{(\alpha-\beta)^2 + k^2}{(\alpha+\beta)^2 + k^2}.
\end{aligned}$$

*) 利用3812题的结果。

***) 易知3796题的结果当 $\alpha > 0$, $\beta = 0$ 时也成立。

3823. 对于不同的 x 值, 求迪里黑里间断乘数

$$D(x) = \frac{2}{\pi} \int_0^{+\infty} \sin \lambda \cos \lambda x \frac{d\lambda}{\lambda},$$

作出函数 $y = D(x)$ 的图形.

解 $D(x) = \frac{1}{\pi} \int_0^{+\infty} \frac{\sin(1+x)\lambda + \sin(1-x)\lambda}{\lambda} d\lambda.$

当 $|x| < 1$ 时, $1+x > 0$ 及 $1-x > 0$, 利用3812题的

结果, 即得 $D(x) = \frac{1}{\pi} \left(\frac{\pi}{2} + \frac{\pi}{2} \right) = 1;$

当 $|x| = 1$ 时, $1+x$ 及 $1-x$ 中总有一个为零, 一个

为正值, 即得 $D(x) = \frac{1}{\pi} \cdot \frac{\pi}{2} = \frac{1}{2};$

当 $|x| > 1$ 时, $(1+x)(1-x) < 0$, 即得 $D(x) = 0.$

如图7·3所示.



图 7·3

3824. 计算积分:

(a) $V.P. \int_{-\infty}^{+\infty} \frac{\sin ax}{x+b} dx;$

$$(6) V.P. \int_{-\infty}^{+\infty} \frac{\cos ax}{x+b} dx.$$

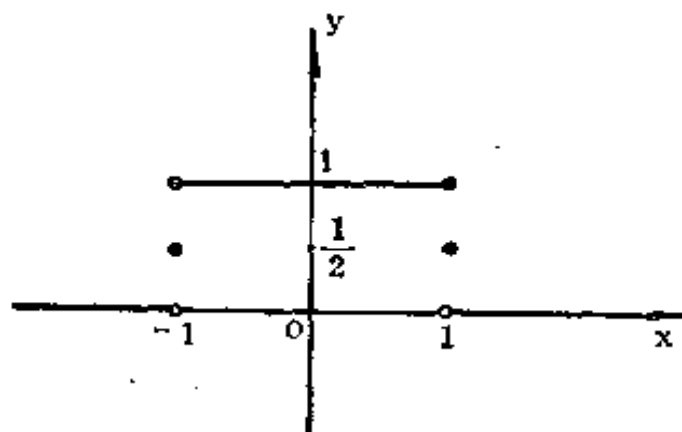
$$\begin{aligned} \text{解 (a) } V.P. \int_{-\infty}^{+\infty} \frac{\sin ax}{x+b} dx &= V.P. \int_{-\infty}^{+\infty} \frac{\sin a(t-b)}{t} dt \\ &= V.P. \int_{-\infty}^{+\infty} \frac{\sin at \cos ab}{t} dt \\ &\quad - V.P. \int_{-\infty}^{+\infty} \frac{\cos at \sin ab}{t} dt \\ &= 2 \int_0^{+\infty} \frac{\sin at}{t} \cos ab dt = \pi \operatorname{sgn} a \cos ab. \end{aligned}$$

类似地，可求得

$$(6) V.P. \int_{-\infty}^{+\infty} \frac{\cos ax}{x+b} dx = \pi \operatorname{sgn} a \sin ab.$$

3825. 利用公式

$$\frac{1}{1+x^2} = \int_0^{+\infty} e^{-y(1+x^2)} dy,$$

计算拉普拉斯积分

$$L = \int_0^{+\infty} \frac{\cos ax}{1+x^2} dx.$$

解 $L = \int_0^{+\infty} \cos ax dx \int_0^{+\infty} e^{-y(1+x^2)} dy$. 由于被积函数 $\cos ax e^{-y(1+x^2)}$ 是 $0 \leq x < +\infty$, $0 \leq y < +\infty$ 上的连续函数，并且绝对值的积分

$$\begin{aligned}
& \int_0^{+\infty} dy \int_0^{+\infty} |e^{-y(1+x^2)} \cos ax| dx \\
& \leq \int_0^{+\infty} e^{-y} dy \int_0^{+\infty} e^{-yx^2} dx \\
& = \frac{\sqrt{\pi}}{2} \int_0^{+\infty} \frac{e^{-y}}{\sqrt{y}} dy = \sqrt{\pi} \int_0^{+\infty} e^{-t^2} dt \\
& = \frac{\pi}{2} < +\infty,
\end{aligned}$$

故原逐次积分可交换积分顺序, 得

$$\begin{aligned}
L &= \int_0^{+\infty} e^{-y} dy \int_0^{+\infty} e^{-yx^2} \cos ax dx \\
&= \int_0^{+\infty} e^{-y} \cdot \frac{1}{2} \sqrt{\frac{\pi}{y}} e^{-\frac{a^2}{4y}} dy \quad *) \\
&= \int_0^{+\infty} \sqrt{\pi} e^{-\left[t^2 + \frac{1}{t^2} \left(\frac{|a|}{2}\right)^2\right]} dt \\
&= \sqrt{\pi} \cdot \frac{\sqrt{\pi}}{2} e^{-2 \cdot \frac{|a|}{2}} \quad **) = \frac{\pi}{2} e^{-|a|}.
\end{aligned}$$

*) 利用3809题的结果.

**) 利用3807题的结果.

3826. 计算积分

$$L_1 = \int_0^{+\infty} \frac{x \sin ax}{1+x^2} dx.$$

解 由于 $\frac{\partial}{\partial a} \left(\frac{\cos ax}{1+x^2} \right) = -\frac{x \sin ax}{1+x^2}$, 故我们

考虑积分 $L = \int_0^{+\infty} \frac{\cos ax}{1+x^2} dx$. 由于 $\left| \frac{\cos ax}{1+x^2} \right| \leq \frac{1}{1+x^2}$, 而 $\int_0^{+\infty} \frac{dx}{1+x^2}$ 收敛, 故 $\int_0^{+\infty} \frac{\cos ax}{1+x^2} dx$ 当 $-\infty < a < +\infty$ 时一致收敛. 又由于当 $a \geq a_0 > 0$ 时,

$$\left| \int_0^A \sin ax dx \right| = \left| \frac{1 - \cos aA}{a} \right| \leq \frac{2}{a_0},$$

而 $\frac{x}{1+x^2}$ 当 $x > 1$ 时递减, 且当 $x \rightarrow +\infty$ 时趋于零;

于是, 由迪里黑里判别法知积分 $\int_0^{+\infty} \frac{x \sin ax}{1+x^2} dx$ 当 $a \geq a_0$ 时一致收敛. 因此, 当 $a \geq a_0$ 时可在积分号下求导数, 得

$$\frac{dL}{da} = -L_1. \quad (1)$$

由 $a_0 > 0$ 的任意性知, (1) 式对一切 $a > 0$ 成立.

由3825题知 当 $a > 0$ 时 $L = \frac{\pi}{2} e^{-a}$. 于是, 由 (1) 式知

$$L_1 = -\frac{dL}{da} = \frac{\pi}{2} e^{-a} \quad (a > 0).$$

显然, 当 $a < 0$ 时,

$$L_1 = -\int_0^{+\infty} \frac{x \sin(-a)x}{1+x^2} dx = -\frac{\pi}{2} e^a;$$

而当 $\alpha = 0$ 时, $L_1 = 0$. 综上所述, 有

$$L_1 = \frac{\pi}{2} \operatorname{sgn} \alpha \cdot e^{-|\alpha|}.$$

计算积分:

$$3827. \int_0^{+\infty} \frac{\sin^2 x}{1+x^2} dx.$$

$$\begin{aligned} \text{解} \quad & \int_0^{+\infty} \frac{\sin^2 x}{1+x^2} dx \\ &= \frac{1}{2} \int_0^{+\infty} \frac{dx}{1+x^2} - \frac{1}{2} \int_0^{+\infty} \frac{\cos 2x}{1+x^2} dx \\ &= \frac{1}{2} \cdot \frac{\pi}{2} - \frac{1}{2} \cdot \frac{\pi}{2} e^{-2} \quad *) = \frac{\pi}{4} (1 - e^{-2}). \end{aligned}$$

*) 利用3825题的结果.

$$3828. \int_0^{+\infty} \frac{\cos \alpha x}{(1+x^2)^2} dx.$$

$$\begin{aligned} \text{解} \quad & \int_0^{+\infty} \frac{\cos \alpha x}{(1+x^2)^2} dx \\ &= \int_0^{+\infty} \frac{\cos \alpha x}{1+x^2} dx - \int_0^{+\infty} \frac{x^2 \cos \alpha x}{(1+x^2)^2} dx \\ &= \frac{\pi}{2} e^{-|\alpha|} + \frac{1}{2} \int_0^{+\infty} x \cos \alpha x d\left(\frac{1}{1+x^2}\right) \\ &= \frac{\pi}{2} e^{-|\alpha|} + \frac{1}{2} \cdot \frac{x \cos \alpha x}{1+x^2} \Big|_0^{+\infty} \\ &\quad - \frac{1}{2} \int_0^{+\infty} \frac{\cos \alpha x - \alpha x \sin \alpha x}{1+x^2} dx \end{aligned}$$

$$\begin{aligned}
&= \frac{\pi}{2} e^{-|a|} - \frac{1}{2} \int_0^{+\infty} \frac{\cos \alpha x}{1+x^2} dx \\
&\quad + \frac{\alpha}{2} \int_0^{+\infty} \frac{x \sin \alpha x}{1+x^2} dx \\
&= \frac{\pi}{2} e^{-|a|} - \frac{\pi}{4} e^{-|a|} + \frac{\alpha}{2} \cdot \frac{\pi}{2} \operatorname{sgn} \alpha \cdot e^{-|a|} \quad *) \\
&= \frac{\pi}{4} (1 + |\alpha|) e^{-|a|}.
\end{aligned}$$

*) 利用3825题与3826题的结果。

$$3829. \int_{-\infty}^{+\infty} \frac{\cos \alpha x}{ax^2 + 2bx + c} dx \quad (a > 0, ac - b^2 > 0).$$

$$\text{解 } ax^2 + 2bx + c = a \left[\left(x + \frac{b}{a} \right)^2 + \frac{ac - b^2}{a^2} \right]. \quad \text{令}$$

$$m = \frac{\sqrt{ac - b^2}}{a}, \quad t = \frac{1}{m} \left(x + \frac{b}{a} \right) \quad (m > 0),$$

$$\text{则 } ax^2 + 2bx + c = am^2(t^2 + 1),$$

$$\cos \alpha x = \cos \alpha \left(mt - \frac{b}{a} \right)$$

$$= \cos \alpha mt \cos \frac{b\alpha}{a} + \sin \alpha mt \sin \frac{b\alpha}{a}.$$

于是,

$$\begin{aligned}
&\int_{-\infty}^{+\infty} \frac{\cos \alpha x}{ax^2 + 2bx + c} dx \\
&= \frac{1}{am} \int_{-\infty}^{+\infty} \frac{\cos \alpha mt \cos \frac{b\alpha}{a}}{1+t^2} dt
\end{aligned}$$

$$+ \frac{1}{am} \int_{-\infty}^{+\infty} \frac{\sin amt \sin \frac{ba}{a}}{1+t^2} dt.$$

由于 $\left| \frac{\cos amt}{1+t^2} \right| \leq \frac{1}{1+t^2}$, 而 $\int_{-\infty}^{+\infty} \frac{dt}{1+t^2} = \pi$ 收

敛, 故积分 $\int_{-\infty}^{+\infty} \frac{\cos amt}{1+t^2} dt$ 收敛. 同理, 积分

$\int_{-\infty}^{+\infty} \frac{\sin amt}{1+t^2} dt$ 收敛. 又由于 $\frac{\cos amt}{1+t^2}$ 为偶函

数, $\frac{\sin amt}{1+t^2}$ 为奇函数, 故

$$\begin{aligned} & \int_{-\infty}^{+\infty} \frac{\cos amt}{1+t^2} dt \\ &= 2 \int_0^{+\infty} \frac{\cos amt}{1+t^2} dt = \pi e^{-\pi|a|} \quad *) \end{aligned}$$

$$\int_{-\infty}^{+\infty} \frac{\sin amt}{1+t^2} dt = 0.$$

从而得

$$\begin{aligned} \int_{-\infty}^{+\infty} \frac{\cos ax}{ax^2 + 2bx + c} dx &= \frac{1}{am} \cos \frac{ba}{a} \cdot \pi e^{-\pi|a|} \\ &= \frac{\pi}{\sqrt{ac-b^2}} \cos \frac{ba}{a} e^{-\frac{|a|\sqrt{ac-b^2}}{a}}. \end{aligned}$$

*) 利用3825题的结果.

3830. 利用公式

$$\frac{1}{\sqrt{x}} = \frac{2}{\sqrt{\pi}} \int_0^{+\infty} e^{-xy^2} dy \quad (x > 0),$$

计算傅伦涅耳积分

$$\int_0^{+\infty} \sin(x^2) dx = \frac{1}{2} \int_0^{+\infty} \frac{\sin x}{\sqrt{x}} dx$$

及

$$\int_0^{+\infty} \cos(x^2) dx = \frac{1}{2} \int_0^{+\infty} \frac{\cos x}{\sqrt{x}} dx.$$

解 在积分

$$\frac{1}{\sqrt{x}} = \frac{2}{\sqrt{\pi}} \int_0^{+\infty} e^{-xy^2} dy$$

的两端乘以 $\sin x$, 再在 $0 < x_0 \leq x \leq x_1$ 上积分, 则得

$$\begin{aligned} & \int_{x_0}^{x_1} \frac{\sin x}{\sqrt{x}} dx \\ &= \frac{2}{\sqrt{\pi}} \int_{x_0}^{x_1} dx \int_0^{+\infty} \sin x \cdot e^{-xy^2} dy. \end{aligned}$$

由于 $|\sin x \cdot e^{-xy^2}| \leq e^{-x_0 y^2}$, 而 $\int_0^{+\infty} e^{-x_0 y^2} dy$ 收

敛, 故积分 $\int_0^{+\infty} \sin x \cdot e^{-xy^2} dy$ 对 $x_0 \leq x \leq x_1$ 一致收

敛, 从而可进行积分顺序的互换, 得

$$\begin{aligned} & \int_{x_0}^{x_1} \frac{\sin x}{\sqrt{x}} dx \\ &= \frac{2}{\sqrt{\pi}} \int_0^{+\infty} dy \int_{x_0}^{x_1} \sin x \cdot e^{-xy^2} dx \end{aligned}$$

$$\begin{aligned}
&= \frac{2}{\sqrt{\pi}} \int_0^{+\infty} \left[-\frac{e^{-xy^2}(y^2 \sin x + \cos x)}{1+y^4} \right] \Big|_{x_0}^{x_1} dy \\
&= \frac{2}{\sqrt{\pi}} \sin x_0 \int_0^{+\infty} \frac{y^2 e^{-x_0 y^2}}{1+y^4} dy \\
&\quad + \frac{2}{\sqrt{\pi}} \cos x_0 \int_0^{+\infty} \frac{e^{-x_0 y^2}}{1+y^4} dy \\
&\quad - \frac{2}{\sqrt{\pi}} \sin x_1 \int_0^{+\infty} \frac{y^2 e^{-x_1 y^2}}{1+y^4} dy \\
&\quad - \frac{2}{\sqrt{\pi}} \cos x_1 \int_0^{+\infty} \frac{e^{-x_1 y^2}}{1+y^4} dy.
\end{aligned}$$

上述等式右端的诸积分分别对 $0 \leq x_0 < +\infty$, $0 \leq x_1 < +\infty$ 都是一致收敛的 (事实上, $e^{-x_0 y^2} \leq 1$, $e^{-x_1 y^2} \leq 1$, 且积分 $\int_0^{+\infty} \frac{y^2}{1+y^4} dy$ 及 $\int_0^{+\infty} \frac{dy}{1+y^4}$ 均收敛), 于是, 它们分别都是 x_0, x_1 ($0 \leq x_n <$

由于上式右端的后两个积分均不超过积分

$$\int_0^{+\infty} e^{-x_1 y^2} dy = \frac{1}{2} \sqrt{\frac{\pi}{x_1}},$$

且 $\lim_{x_1 \rightarrow +\infty} \sqrt{\frac{\pi}{x_1}} = 0$, 故令 $x_1 \rightarrow +\infty$, 即得

$$\begin{aligned} \int_0^{+\infty} \frac{\sin x}{\sqrt{x}} dx &= \frac{2}{\sqrt{\pi}} \int_0^{+\infty} \frac{dy}{1+y^2} \\ &= \frac{2}{\sqrt{\pi}} \cdot \frac{\pi}{2\sqrt{2}} = \sqrt{\frac{\pi}{2}}. \end{aligned}$$

最后得

$$\int_0^{+\infty} \sin(x^2) dx = \frac{1}{2} \int_0^{+\infty} \frac{\sin x}{\sqrt{x}} dx = \frac{\sqrt{\pi}}{2\sqrt{2}}.$$

同法可得

$$\int_0^{+\infty} \cos(x^2) dx = \frac{\sqrt{\pi}}{2\sqrt{2}}.$$

求下列积分之值:

3831. $\int_{-\infty}^{+\infty} \sin(ax^2 + 2bx + c) dx \quad (a \neq 0).$

$$\begin{aligned} \text{解} \quad & \int_{-\infty}^{+\infty} \sin(ax^2 + 2bx + c) dx \\ &= \int_{-\infty}^{+\infty} \sin a \left[\left(x + \frac{b}{a} \right)^2 + \frac{ac - b^2}{a^2} \right] dx \\ &= \int_{-\infty}^{+\infty} \sin \left(at^2 + \frac{ac - b^2}{a} \right) dt \end{aligned}$$

$$\begin{aligned}
&= \cos \frac{ac-b^2}{a} \int_{-\infty}^{+\infty} \sin at^2 dt \\
&\quad + \sin \frac{ac-b^2}{a} \int_{-\infty}^{+\infty} \cos at^2 dt \\
&= \operatorname{sgn} a \cdot \cos \frac{ac-b^2}{a} \cdot \frac{1}{\sqrt{|a|}} \int_{-\infty}^{+\infty} \sin y^2 dy \\
&\quad + \sin \frac{ac-b^2}{a} \cdot \frac{1}{\sqrt{|a|}} \int_{-\infty}^{+\infty} \cos y^2 dy \\
&= \sqrt{\frac{\pi}{2|a|}} \left(\operatorname{sgn} a \cdot \cos \frac{ac-b^2}{a} \right. \\
&\quad \left. + \sin \frac{ac-b^2}{a} \right) *) \\
&= \sqrt{\frac{\pi}{|a|}} \sin \left(\frac{ac-b^2}{a} + \frac{\pi}{4} \operatorname{sgn} a \right).
\end{aligned}$$

*) 利用3830题的结果.

3832. $\int_{-\infty}^{+\infty} \sin x^2 \cdot \cos 2ax dx,$

解 $\int_{-\infty}^{+\infty} \sin x^2 \cdot \cos 2ax dx$

$$\begin{aligned}
&= \frac{1}{2} \int_{-\infty}^{+\infty} [\sin(x^2 + 2ax) + \sin(x^2 - 2ax)] dx \\
&= \frac{1}{2} \left[\sqrt{\pi} \sin \left(\frac{\pi}{4} - a^2 \right) + \sqrt{\pi} \sin \left(\frac{\pi}{4} - a^2 \right) \right] *) \\
&= \sqrt{\pi} \sin \left(\frac{\pi}{4} - a^2 \right) = \sqrt{\pi} \cos \left(\frac{\pi}{4} + a^2 \right).
\end{aligned}$$

*) 利用3831题的结果.

$$3833. \int_{-\infty}^{+\infty} \cos x^2 \cdot \cos 2ax \, dx,$$

$$\begin{aligned} \text{解} \quad & \int_{-\infty}^{+\infty} \cos x^2 \cdot \cos 2ax \, dx \\ &= \frac{1}{2} \int_{-\infty}^{+\infty} [\cos(x^2 + 2ax) + \cos(x^2 - 2ax)] \, dx \\ &= \frac{1}{2} \int_{-\infty}^{+\infty} \left[\sin\left(x^2 + 2ax + \frac{\pi}{2}\right) \right. \\ & \quad \left. + \sin\left(x^2 - 2ax + \frac{\pi}{2}\right) \right] \, dx \\ &= \frac{1}{2} \cdot 2\sqrt{\pi} \sin\left(\frac{\pi}{2} - a^2 + \frac{\pi}{4}\right) \quad *) \\ &= \sqrt{\pi} \sin\left(\frac{\pi}{4} + a^2\right). \end{aligned}$$

*) 利用3831题的结果.

3834. 证明公式:

$$1) \int_0^{+\infty} \frac{\cos ax}{a^2 - x^2} \, dx = \frac{\pi}{2a} \sin aa \quad (a \geq 0),$$

$$2) \int_0^{+\infty} \frac{x \sin ax}{a^2 - x^2} \, dx = -\frac{\pi}{2} \cos aa \quad (a > 0),$$

这里 $a \neq 0$, 积分应了解为在哥西意义上的主值.

$$\text{证} \quad 1) \int_0^{+\infty} \frac{\cos ax}{a^2 - x^2} \, dx$$

$$\begin{aligned}
&= \lim_{\substack{\eta \rightarrow +0 \\ A \rightarrow +\infty}} \left[\int_0^{a-\eta} \frac{\cos \alpha x}{a^2 - x^2} dx \right. \\
&\quad \left. + \int_{a+\eta}^A \frac{\cos \alpha x}{a^2 - x^2} dx \right] \\
&= \frac{1}{2a} \lim_{\substack{\eta \rightarrow +0 \\ A \rightarrow +\infty}} \left[\int_0^{a-\eta} \frac{\cos \alpha x}{a-x} dx \right. \\
&\quad \left. + \int_0^{a-\eta} \frac{\cos \alpha x}{a+x} dx + \int_{a+\eta}^A \frac{\cos \alpha x}{a-x} dx \right. \\
&\quad \left. + \int_{a+\eta}^A \frac{\cos \alpha x}{a+x} dx \right] \\
&= \frac{1}{2a} \lim_{\substack{\eta \rightarrow +0 \\ A \rightarrow +\infty}} \left[- \int_a^\eta \frac{\cos \alpha(a-t)}{t} dt \right. \\
&\quad \left. + \int_a^{2a-\eta} \frac{\cos \alpha(t-a)}{t} dt \right. \\
&\quad \left. - \int_\eta^{A-a} \frac{\cos \alpha(t+a)}{t} dt \right. \\
&\quad \left. + \int_{2a+\eta}^{A+a} \frac{\cos \alpha(t-a)}{t} dt \right] \\
&= \frac{1}{2a} \lim_{\substack{\eta \rightarrow +0 \\ A \rightarrow +\infty}} \left[\int_\eta^{A-a} \frac{\cos \alpha(t-a)}{t} dt \right. \\
&\quad \left. + \int_{A-a}^{A+a} \frac{\cos \alpha(t-a)}{t} dt \right. \\
&\quad \left. + \int_{2a+\eta}^{2a-\eta} \frac{\cos \alpha(t-a)}{t} dt \right]
\end{aligned}$$

$$\begin{aligned}
& - \int_{\eta}^{A-a} \frac{\cos \alpha(t+a)}{t} dt \Big] \\
= & \frac{1}{2a} \lim_{\substack{\eta \rightarrow +0 \\ A \rightarrow +\infty}} \left[\int_{\eta}^{A-a} \frac{\cos \alpha(t-a) - \cos \alpha(t+a)}{t} dt \right. \\
& + \int_{A-a}^{A+a} \frac{\cos \alpha(t-a)}{t} dt \\
& \left. - \int_{2a-\eta}^{2a+\eta} \frac{\cos \alpha(t-a)}{t} dt \right] \\
= & \frac{1}{2a} \lim_{\substack{\eta \rightarrow +0 \\ A \rightarrow +\infty}} \int_{\eta}^{A-a} \frac{2 \sin \alpha t \sin \alpha a}{t} dt \\
& + \frac{1}{2a} \lim_{A \rightarrow +\infty} \int_{A-a}^{A+a} \frac{\cos \alpha(t-a)}{t} dt \\
& - \frac{1}{2a} \lim_{\eta \rightarrow +0} \int_{2a-\eta}^{2a+\eta} \frac{\cos \alpha(t-a)}{t} dt \\
= & \frac{\sin \alpha a}{a} \int_0^{+\infty} \frac{\sin \alpha t}{t} dt = \frac{\pi}{2a} \sin \alpha a \quad *).
\end{aligned}$$

$$\begin{aligned}
2) \quad & \int_0^{+\infty} \frac{x \sin \alpha x}{a^2 - x^2} dx \\
= & \lim_{\substack{\eta \rightarrow +0 \\ A \rightarrow +\infty}} \left[\int_0^{a-\eta} \frac{x \sin \alpha x}{a^2 - x^2} dx \right. \\
& \left. + \int_{a+\eta}^A \frac{x \sin \alpha x}{a^2 - x^2} dx \right] \\
= & -\frac{1}{2} \lim_{\substack{\eta \rightarrow +0 \\ A \rightarrow +\infty}} \left[\int_0^{a-\eta} \frac{\sin \alpha x}{x-a} dx \right.
\end{aligned}$$

$$\begin{aligned}
& + \int_0^{a-\eta} \frac{\sin \alpha x}{x+a} dx + \int_{a+\eta}^A \frac{\sin \alpha x}{x-a} dx \\
& + \int_{a+\eta}^A \frac{\sin \alpha x}{x+a} dx \Big] \\
= & -\frac{1}{2} \lim_{\substack{\eta \rightarrow +0 \\ A \rightarrow +\infty}} \left[\int_{-a}^{-\eta} \frac{\sin \alpha(t+a)}{t} dt \right. \\
& + \int_a^{2a-\eta} \frac{\sin \alpha(t-a)}{t} dt \\
& + \int_{\eta}^{A-a} \frac{\sin \alpha(t+a)}{t} dt \\
& \left. + \int_{2a+\eta}^{A+a} \frac{\sin \alpha(t-a)}{t} dt \right] \\
= & -\frac{1}{2} \lim_{\substack{\eta \rightarrow +0 \\ A \rightarrow +\infty}} \left[\int_{\eta}^a \frac{\sin \alpha(t-a)}{t} dt \right. \\
& + \int_a^{2a-\eta} \frac{\sin \alpha(t-a)}{t} dt \\
& + \int_{\eta}^{A-a} \frac{\sin \alpha(t+a)}{t} dt \\
& \left. + \int_{2a+\eta}^{A+a} \frac{\sin \alpha(t-a)}{t} dt \right] \\
= & -\frac{1}{2} \lim_{\substack{\eta \rightarrow +0 \\ A \rightarrow +\infty}} \left[\int_{\eta}^{A-a} \frac{\sin \alpha(t-a) + \sin \alpha(t+a)}{t} dt \right. \\
& \left. + \int_{A-a}^{A+a} \frac{\sin \alpha(t-a)}{t} dt \right]
\end{aligned}$$

$$\begin{aligned}
& + \int_{2a+\eta}^{2a-\eta} \frac{\sin \alpha(t-a)}{t} dt \Big] \\
= & -\frac{1}{2} \lim_{\substack{\eta \rightarrow +0 \\ A \rightarrow +\infty}} \int_t^{A-a} \frac{2 \sin \alpha t \cos \alpha a}{t} dt \\
& - \frac{1}{2} \lim_{A \rightarrow +\infty} \int_{A-a}^{A+a} \frac{\sin \alpha(t-a)}{t} dt \\
& + \frac{1}{2} \lim_{\eta \rightarrow +0} \int_{2a-\eta}^{2a+\eta} \frac{\sin \alpha(t-a)}{t} dt \\
= & -\cos \alpha a \int_0^{+\infty} \frac{\sin \alpha t}{t} dt \\
= & -\frac{\pi}{2} \cos \alpha a \quad *) .
\end{aligned}$$

*) 利用3812题的结果.

编者注: 原题1) 应加上条件 $\alpha \geq 0$, 当 $\alpha < 0$ 时, 有

$$\begin{aligned}
& \int_0^{+\infty} \frac{\cos \alpha x}{a^2 - x^2} dx \\
= & \int_0^{+\infty} \frac{\cos(-\alpha)x}{a^2 - x^2} dx = \frac{\pi}{2a} \sin \alpha(-\alpha) \\
= & -\frac{\pi}{2a} \sin \alpha a .
\end{aligned}$$

原题2) 应加上条件 $\alpha > 0$, 当 $\alpha = 0$ 时等式显然不成立(左端等于0, 右端等于 $-\frac{\pi}{2}$); 当 $\alpha < 0$ 时, 有

$$\begin{aligned}
& \int_0^{+\infty} \frac{x \sin ax}{a^2 - x^2} dx \\
&= - \int_0^{+\infty} \frac{x \sin(-a)x}{a^2 - x^2} dx \\
&= - \left[-\frac{\pi}{2} \cos a(-a) \right] = \frac{\pi}{2} \cos aa.
\end{aligned}$$

3835. 对于函数 $f(t)$, 求拉普拉斯变换

$$F(p) = \int_0^{+\infty} e^{-pt} f(t) dt \quad (p > 0).$$

设:

(a) $f(t) = t^n$ (n 为自然数); (б) $f(t) = \sqrt{t}$;

(B) $f(t) = e^{at}$; (Г) $f(t) = t e^{-at}$;

(Д) $f(t) = \cos t$; (e) $f(t) = \frac{1 - e^{-t}}{t}$;

(ж) $f(t) = \sin a \sqrt{t}$.

解 (a) $F(p) = \int_0^{+\infty} e^{-pt} t^n dt$

$$\begin{aligned}
&= -\frac{1}{p} e^{-pt} t^n \Big|_0^{+\infty} + \frac{n}{p} \int_0^{+\infty} e^{-pt} t^{n-1} dt \\
&= \frac{n}{p} \int_0^{+\infty} e^{-pt} t^{n-1} dt \\
&\stackrel{n-1 \text{ 次}}{=} \dots = \frac{n!}{p^n} \int_0^{+\infty} e^{-pt} dt = \frac{n!}{p^{n+1}}.
\end{aligned}$$

(б) $F(p) = \int_0^{+\infty} e^{-pt} \sqrt{t} dt$

$$\begin{aligned}
&= -\frac{1}{p} e^{-pt} \sqrt{t} \Big|_0^{+\infty} \\
&\quad + \frac{1}{2p} \int_0^{+\infty} e^{-pt} \frac{dt}{\sqrt{t}} \\
&= \frac{1}{p} \int_0^{+\infty} e^{-pu^2} du = \frac{\sqrt{\pi}}{2p\sqrt{p}}.
\end{aligned}$$

$$(B) F(p) = \int_0^{+\infty} e^{-pt} e^{\alpha t} dt = \int_0^{+\infty} e^{(\alpha-p)t} dt.$$

当 $p > \alpha$ 时, $F(p) = \frac{1}{p-\alpha}$; 当 $p \leq \alpha$ 时, 积分发散.

$$\begin{aligned}
(\Gamma) F(p) &= \int_0^{+\infty} e^{-pt} t e^{-\alpha t} dt \\
&= \int_0^{+\infty} t e^{-(p+\alpha)t} dt \\
&= \frac{1}{(p+\alpha)^2} \quad (p+\alpha > 0) \quad *).
\end{aligned}$$

*) 利用本题 (a) 的结果: $n=1$.

$$\begin{aligned}
(\Delta) F(p) &= \int_0^{+\infty} e^{-pt} \cos t dt \\
&= \frac{-p \cos t + \sin t}{p^2 + 1} e^{-pt} \Big|_0^{+\infty} \\
&= \frac{p}{p^2 + 1}.
\end{aligned}$$

$$(\Theta) F(p) = \int_0^{+\infty} e^{-pt} \frac{1-e^{-t}}{t} dt.$$

由于 $\lim_{t \rightarrow +0} \frac{1-e^{-t}}{t} = 1$, $\lim_{t \rightarrow +\infty} \frac{1-e^{-t}}{t} = 0$, 故函数

$\frac{1-e^{-t}}{t}$ 有界:

$$0 < \frac{1-e^{-t}}{t} \leq M = \text{常数} \quad (0 < t < +\infty).$$

由此可知, 当 $p > 0$ 时, 积分 $\int_0^{+\infty} e^{-pt} \frac{1-e^{-t}}{t} dt$ 收敛, 并且

$$\begin{aligned} 0 < F(p) &\leq M \int_0^{+\infty} e^{-pt} dt \\ &= \frac{M}{p} \quad (0 < p < +\infty). \end{aligned} \quad (1)$$

再考虑积分

$$\begin{aligned} &\int_0^{+\infty} \frac{\partial}{\partial p} \left(e^{-pt} \frac{1-e^{-t}}{t} \right) dt \\ &= \int_0^{+\infty} e^{-pt} (e^{-t} - 1) dt \\ &= \int_0^{+\infty} e^{-(p+1)t} dt - \int_0^{+\infty} e^{-pt} dt \\ &= \frac{1}{p+1} - \frac{1}{p} \quad (p > 0), \end{aligned}$$

它对 $p \geq p_0 > 0$ 是一致收敛的. 因此, 当 $p \geq p_0$ 时, 可对函数 $F(p)$ 应用莱布尼兹法则, 得

$$F'(p) = \frac{1}{p+1} - \frac{1}{p} \quad (\text{当 } p \geq p_0 \text{ 时}).$$

由 $p_0 > 0$ 的任意性知, 上式对一切 $p > 0$ 均成立. 两端积分, 得

$$F(p) = \ln \frac{p+1}{p} + C \quad (0 < p < +\infty), \quad (2)$$

其中 C 是某常数. 由 (1) 式知

$$\lim_{p \rightarrow +\infty} F(p) = 0.$$

于是, 在 (2) 式两端令 $p \rightarrow +\infty$, 取极限, 得 $C = 0$. 由此可知

$$F(p) = \ln \frac{p+1}{p} = \ln \left(1 + \frac{1}{p} \right).$$

$$\begin{aligned} (\text{K}) \quad F(p) &= \int_0^{+\infty} e^{-pt} \sin a \sqrt{t} dt \\ &= 2 \int_0^{+\infty} u e^{-pu^2} \sin au du \\ &= \frac{a\sqrt{\pi}}{2p\sqrt{p}} e^{-\frac{a^2}{4p}} \quad *) \end{aligned}$$

*) 利用 3810 题的结果.

3836. 证明公式 (李普希兹积分)

$$\int_0^{+\infty} e^{-at} J_0(bt) dt = \frac{1}{\sqrt{a^2 + b^2}} \quad (a > 0),$$

其中 $J_0(x) = \frac{1}{\pi} \int_0^\pi \cos(x \sin \varphi) d\varphi$ 为足指数是 0 的贝塞耳函数 (参阅 3726 题).

证 $\int_0^{+\infty} e^{-at} J_0(bt) dt$

$$\begin{aligned}
&= \frac{1}{\pi} \int_0^{+\infty} e^{-at} dt \int_0^\pi \cos(bt \sin \varphi) d\varphi. \text{ 由于积分} \\
&\int_0^{+\infty} e^{-at} \cos(bt \sin \varphi) dt \text{ 对 } 0 \leq \varphi \leq \pi \text{ 是一致收敛的,} \\
&\text{故可交换积分顺序, 得} \\
&\int_0^{+\infty} e^{-at} J_0(bt) dt \\
&= \frac{1}{\pi} \int_0^\pi d\varphi \int_0^{+\infty} e^{-at} \cos(bt \sin \varphi) dt \\
&= \frac{1}{\pi} \int_0^\pi \left(\frac{-a \cos(bt \cos \varphi) + b \sin \varphi \sin(bt \sin \varphi)}{a^2 + b^2 \sin^2 \varphi} e^{-at} \Big|_0^{+\infty} \right) d\varphi \\
&= \frac{a}{\pi} \int_0^\pi \frac{d\varphi}{a^2 + b^2 \sin^2 \varphi} = \frac{2a}{\pi} \int_0^{\frac{\pi}{2}} \frac{d\varphi}{a^2 + b^2 \sin^2 \varphi} \\
&= \frac{2a}{\pi} \int_0^{\frac{\pi}{2}} \frac{d(\operatorname{tg} \varphi)}{(a^2 + b^2) \operatorname{tg}^2 \varphi + a^2} \\
&= \frac{2a}{\pi} \int_0^{+\infty} \frac{dt}{(a^2 + b^2)t^2 + a^2} \\
&= \frac{2a}{\pi} \cdot \frac{1}{a \sqrt{a^2 + b^2}} \operatorname{arc} \operatorname{tg} \frac{\sqrt{a^2 + b^2} t}{a} \Big|_0^{+\infty} \\
&= \frac{1}{\sqrt{a^2 + b^2}}.
\end{aligned}$$

3837. 求外耳什特拉斯变换

$$F(x) = \frac{1}{\sqrt{\pi}} \int_{-\infty}^{+\infty} e^{-(x-y)^2} f(y) dy.$$

设:

$$(a) f(y) = 1;$$

$$(b) f(y) = y^2;$$

$$(B) f(y) = e^{2ay};$$

$$(r) f(y) = \cos ay.$$

$$\begin{aligned} \text{解 (a)} \quad F(x) &= \frac{1}{\sqrt{\pi}} \int_{-\infty}^{+\infty} e^{-(x-y)^2} dy \\ &= \frac{1}{\sqrt{\pi}} \int_{-\infty}^{+\infty} e^{-u^2} du \\ &= \frac{2}{\sqrt{\pi}} \cdot \frac{\sqrt{\pi}}{2} = 1. \end{aligned}$$

$$\begin{aligned} (b) \quad F(x) &= \frac{1}{\sqrt{\pi}} \int_{-\infty}^{+\infty} e^{-(x-y)^2} y^2 dy \\ &= \frac{1}{\sqrt{\pi}} \int_{-\infty}^{+\infty} e^{-u^2} (x+u)^2 du \\ &= \frac{1}{\sqrt{\pi}} \int_{-\infty}^{+\infty} e^{-u^2} u^2 du \\ &\quad + \frac{2x}{\sqrt{\pi}} \int_{-\infty}^{+\infty} e^{-u^2} u du \\ &\quad + \frac{x^2}{\sqrt{\pi}} \int_{-\infty}^{+\infty} e^{-u^2} du. \end{aligned}$$

由于

$$\begin{aligned} &\frac{1}{\sqrt{\pi}} \int_{-\infty}^{+\infty} e^{-u^2} u^2 du \\ &= \frac{2}{\sqrt{\pi}} \int_0^{+\infty} u^2 e^{-u^2} du = -\frac{1}{\sqrt{\pi}} \int_0^{+\infty} u d(e^{-u^2}) \\ &= -\frac{1}{\sqrt{\pi}} u e^{-u^2} \Big|_0^{+\infty} + \frac{1}{\sqrt{\pi}} \int_0^{+\infty} e^{-u^2} du \end{aligned}$$

$$= \frac{1}{\sqrt{\pi}} \cdot \frac{\sqrt{\pi}}{2} = \frac{1}{2},$$

及

$$\int_{-\infty}^{+\infty} e^{-u^2} u du = 0,$$

故得

$$F(x) = \frac{1}{2} + \frac{2x^2}{\sqrt{\pi}} \cdot \frac{\sqrt{\pi}}{2} = x^2 + \frac{1}{2}.$$

$$\begin{aligned} \text{(B)} \quad F(x) &= \frac{1}{\sqrt{\pi}} \int_{-\infty}^{+\infty} e^{-(x-y)^2} e^{2ay} dy \\ &= \frac{1}{\sqrt{\pi}} \int_{-\infty}^{+\infty} e^{-(x-y)^2 + 2ay} dy \\ &= \frac{1}{\sqrt{\pi}} e^{a^2 + 2ax} \cdot \int_{-\infty}^{+\infty} e^{-(y-x-a)^2} dy \\ &= \frac{1}{\sqrt{\pi}} e^{a^2 + 2ax} \cdot 2 \cdot \frac{\sqrt{\pi}}{2} \\ &= e^{a^2 + 2ax}. \end{aligned}$$

$$\begin{aligned} \text{(r)} \quad F(x) &= \frac{1}{\sqrt{\pi}} \int_{-\infty}^{+\infty} e^{-(x-y)^2} \cos ay dy \\ &= \frac{1}{\sqrt{\pi}} \int_{-\infty}^{+\infty} e^{-u^2} \cos a(x+u) du \\ &= \frac{\cos ax}{\sqrt{\pi}} \cdot \int_{-\infty}^{+\infty} e^{-u^2} \cos au du \\ &\quad - \frac{\sin ax}{\sqrt{\pi}} \cdot \int_{-\infty}^{+\infty} e^{-u^2} \sin au du \end{aligned}$$

$$\begin{aligned}
 &= \frac{\cos ax}{\sqrt{\pi}} \cdot \frac{2}{2} \sqrt{\pi} e^{-\frac{a^2}{4}} - 0 \\
 &= e^{-\frac{a^2}{4}} \cos ax.
 \end{aligned}$$

*) 利用3809题的结果.

3838. 契贝协夫—厄耳米特多项式由公式

$$H_n(x) = (-1)^n e^{x^2} \frac{d^n}{dx^n} (e^{-x^2}) \quad (n=0, 1, 2, \dots)$$

而定义, 证明

$$\int_{-\infty}^{+\infty} H_m(x) H_n(x) e^{-x^2} dx = \begin{cases} 0, & \text{若 } m \neq n; \\ 2^n n! \sqrt{\pi}, & \text{若 } m = n. \end{cases}$$

证 由1231题的结果知, $H_n(x)$ 为一个 n 次多项式, 且 x^n 的系数为 2^n . 不妨设 $m \leq n$, 则

$$\begin{aligned}
 & \int_{-\infty}^{+\infty} H_m(x) H_n(x) e^{-x^2} dx \\
 &= \int_{-\infty}^{+\infty} (-1)^n H_m(x) \frac{d^n}{dx^n} (e^{-x^2}) dx \\
 &= (-1)^n \int_{-\infty}^{+\infty} H_m(x) d \left[\frac{d^{n-1}}{dx^{n-1}} (e^{-x^2}) \right] \\
 &= (-1)^{n+1} \int_{-\infty}^{+\infty} H'_m(x) \cdot \frac{d^{n-1}}{dx^{n-1}} (e^{-x^2}) dx \\
 &= \dots = (-1)^{n+m} \int_{-\infty}^{+\infty} H_n^{(m)}(x) \frac{d^{n-m}}{dx^{n-m}} (e^{-x^2}) dx
 \end{aligned}$$

$$= \dots = (-1)^{2n} \int_{-\infty}^{+\infty} H_n^{(n)}(x) e^{-x^2} dx.$$

当 $m < n$ 时, $H_m^{(n)}(x) = 0$, 故

$$\int_{-\infty}^{+\infty} H_m(x) H_n(x) e^{-x^2} dx = 0;$$

当 $m = n$ 时, $H_n^{(n)}(x) = 2^n n!$, 故

$$\begin{aligned} & \int_{-\infty}^{+\infty} H_n(x) H_n(x) e^{-x^2} dx \\ &= 2^n n! \int_{-\infty}^{+\infty} e^{-x^2} dx = 2^n n! \sqrt{\pi}. \end{aligned}$$

3839. 计算在概率论中有重要意义的积分

$$\begin{aligned} \varphi(x) &= \frac{1}{2\pi\sigma_1\sigma_2} \int_{-\infty}^{+\infty} e^{-\frac{\xi^2}{2\sigma_1^2}} e^{-\frac{(x-\xi)^2}{2\sigma_2^2}} d\xi \\ & \quad (\sigma_1 > 0, \sigma_2 > 0). \end{aligned}$$

解 注意到

$$\begin{aligned} & \frac{\xi^2}{2\sigma_1^2} + \frac{(x-\xi)^2}{2\sigma_2^2} \\ &= \frac{1}{2\sigma_1^2\sigma_2^2} [(\sigma_1^2 + \sigma_2^2)\xi^2 - 2\sigma_1^2 x\xi + \sigma_1^2 x^2], \end{aligned}$$

并令

$$a = \frac{\sigma_1^2 + \sigma_2^2}{2\sigma_1^2\sigma_2^2}, \quad b = \frac{\sigma_1^2 x}{2\sigma_1^2\sigma_2^2},$$

$$c = \frac{\sigma_1^2 x^2}{2\sigma_1^2\sigma_2^2},$$

即得

$$\begin{aligned}\varphi(x) &= \frac{1}{2\pi\sigma_1\sigma_2} \int_{-\infty}^{+\infty} e^{-(a\xi^2+2b\xi+c)} d\xi \\ &= \frac{1}{2\pi\sigma_1\sigma_2} \cdot \sqrt{\frac{\pi}{a}} e^{-\frac{ac-b^2}{a}} \quad *).\end{aligned}$$

將 a, b, c 的表达式代入上式, 并令 $\sigma = \sqrt{\sigma_1^2 + \sigma_2^2}$, 化简整理得

$$\varphi(x) = \frac{1}{\sigma\sqrt{2\pi}} e^{-\frac{x^2}{2\sigma^2}}.$$

*.) 利用3804题的结果.

3840. 设函数 $f(x)$ 在区间 $(-\infty, +\infty)$ 内连续且绝对可积分*). 证明: 积分

$$u(x, t) = \frac{1}{2a\sqrt{\pi t}} \int_{-\infty}^{+\infty} f(\xi) e^{-\frac{(\xi-x)^2}{4a^2t}} d\xi$$

满足热传导方程式

$$\frac{\partial u}{\partial t} = a^2 \frac{\partial^2 u}{\partial x^2}$$

及初值条件

$$\lim_{t \rightarrow +0} u(x, t) = f(x).$$

证 当 $t > 0$, $-\infty < x < +\infty$ 时,

$$\begin{aligned}& \left| f(\xi) e^{-\frac{(\xi-x)^2}{4a^2t}} \right| \leq |f(\xi)|, \text{ 而 } \int_{-\infty}^{+\infty} |f(\xi)| d\xi \\ & < +\infty, \text{ 故积分 } \int_{-\infty}^{+\infty} f(\xi) e^{-\frac{(\xi-x)^2}{4a^2t}} d\xi \text{ 在 } t > 0, \end{aligned}$$

$-\infty < x < +\infty$ 上一致收敛, 从而 $u(x, t)$ 是 $t > 0$, $-\infty < x < +\infty$ 上的连续函数. 考虑积分

$$\begin{aligned} & \int_{-\infty}^{+\infty} \frac{\partial}{\partial t} \left(f(\xi) e^{-\frac{(\xi-x)^2}{4a^2t}} \right) d\xi \\ &= \int_{-\infty}^{+\infty} f(\xi) e^{-\frac{(\xi-x)^2}{4a^2t}} \frac{(\xi-x)^2}{4a^2t^2} d\xi, \end{aligned} \quad (1)$$

$$\begin{aligned} & \int_{-\infty}^{+\infty} \frac{\partial}{\partial x} \left(f(\xi) e^{-\frac{(\xi-x)^2}{4a^2t}} \right) d\xi \\ &= \int_{-\infty}^{+\infty} f(\xi) e^{-\frac{(\xi-x)^2}{4a^2t}} \frac{\xi-x}{2a^2t} d\xi, \end{aligned} \quad (2)$$

$$\begin{aligned} & \int_{-\infty}^{+\infty} \frac{\partial^2}{\partial x^2} \left(f(\xi) e^{-\frac{(\xi-x)^2}{4a^2t}} \right) d\xi \\ &= \int_{-\infty}^{+\infty} f(\xi) e^{-\frac{(\xi-x)^2}{4a^2t}} \left[-\frac{1}{2a^2t} \right. \\ & \quad \left. + \frac{(\xi-x)^2}{4a^4t^2} \right] d\xi, \end{aligned} \quad (3)$$

先考察 (1) 式中的积分:

由于对 $|x| \leq x_0$, $0 < t_0 \leq t \leq t_1$ (x_0, t_0, t_1 任意固定), 当 $|\xi| > x_0$ 时, 有

$$\begin{aligned} & \left| f(\xi) e^{-\frac{(\xi-x)^2}{4a^2t}} \cdot \frac{(\xi-x)^2}{4a^2t^2} \right| \\ & \leq |f(\xi)| \cdot e^{-\frac{(|\xi|-x_0)^2}{4a^2t_1}} \cdot \frac{(|\xi|+x_0)^2}{4a^2t_0^2}, \end{aligned}$$

而

$$\lim_{|\xi| \rightarrow +\infty} e^{-\frac{(|\xi|-x_0)^2}{4a^2 t_1}} \cdot \frac{(|\xi|+x_0)^2}{4a^2 t_0^2} = 0,$$

故当 $|\xi| > x_0$ 时, 有

$$\left| f(\xi) e^{-\frac{(\xi-x)^2}{4a^2 t}} \cdot \frac{(\xi-x)^2}{4a^2 t^2} \right| \leq M |f(\xi)|,$$

其中 M 是某常数. 于是, 根据 $\int_{-\infty}^{+\infty} |f(\xi)| d\xi < +\infty$,

由外氏判别法知, (1) 式中的积分在 $|x| \leq x_0$, $0 < t_0 \leq t \leq t_1$ 上一致收敛.

同理可证, (2) 式中的积分和 (3) 式中的积分都在 $|x| \leq x_0$, $0 < t_0 \leq t \leq t_1$ 上一致收敛. 于是, 在其上可应用莱布尼兹法则在积分号下求导数, 得

$$\frac{\partial u}{\partial t} = \frac{1}{4at\sqrt{\pi t}} \cdot \int_{-\infty}^{+\infty} f(\xi) e^{-\frac{(\xi-x)^2}{4a^2 t}} \left[\frac{(\xi-x)^2}{2a^2 t} - 1 \right] d\xi, \quad (4)$$

$$\frac{\partial u}{\partial x} = \frac{1}{2a\sqrt{\pi t}} \cdot \int_{-\infty}^{+\infty} f(\xi) e^{-\frac{(\xi-x)^2}{4a^2 t}} \frac{\xi-x}{2a^2 t} d\xi, \quad (5)$$

$$\frac{\partial^2 u}{\partial x^2} = \frac{1}{4a^3 t \sqrt{\pi t}} \cdot \int_{-\infty}^{+\infty} f(\xi) e^{-\frac{(\xi-x)^2}{4a^2 t}} \left[\frac{(\xi-x)^2}{2a^2 t} - 1 \right] d\xi. \quad (6)$$

由 x_0, t_0, t_1 的任意性知, (4)、(5)、(6) 三式对一切 $-\infty < x < +\infty, t > 0$ 都成立. 根据 (4) 式及 (6) 式, 即得

$$\frac{\partial u}{\partial t} = a^2 \frac{\partial^2 u}{\partial x^2} \quad (-\infty < x < +\infty, t > 0).$$

下面证明

$$\lim_{t \rightarrow +0} u(x, t) = f(x) \quad (-\infty < x < +\infty). \quad (7)$$

任意固定 x , 易知 ($t > 0$, 作变量代换 $u = \frac{\xi - x}{2a\sqrt{t}}$)

$$\begin{aligned} & \int_{-\infty}^{+\infty} e^{-\frac{(\xi-x)^2}{4a^2t}} d\xi \\ &= 2a\sqrt{t} \int_{-\infty}^{+\infty} e^{-u^2} du = 2a\sqrt{\pi t}, \end{aligned}$$

故

$$\begin{aligned} & u(x, t) - f(x) \\ &= \frac{1}{2a\sqrt{\pi t}} \int_{-\infty}^{+\infty} [f(\xi) - f(x)] e^{-\frac{(\xi-x)^2}{4a^2t}} d\xi. \end{aligned}$$

任给 $\varepsilon > 0$. 根据 $f(x)$ 在点 x 的连续性, 可取某 $\delta > 0$, 使当 $|\xi - x| \leq \delta$ 时, 恒有 $|f(\xi) - f(x)| < \frac{\varepsilon}{3}$.

我们有

$$\begin{aligned} & u(x, t) - f(x) \\ &= \frac{1}{2a\sqrt{\pi t}} \left(\int_{-\infty}^{x-\delta} + \int_{x-\delta}^{x+\delta} + \int_{x+\delta}^{+\infty} \right) \end{aligned}$$

$$\begin{aligned}
& + \int_{x+\delta}^{+\infty} [f(\xi) - f(x)] e^{-\frac{(\xi-x)^2}{4a^2t}} d\xi \\
& = I_1 + I_2 + I_3.
\end{aligned}$$

下面分别估计 I_1 , I_2 与 I_3 . 我们有

$$\begin{aligned}
|I_2| &= \left| \frac{1}{2a\sqrt{\pi t}} \int_{x-\delta}^{x+\delta} [f(\xi) \right. \\
& \quad \left. - f(x)] e^{-\frac{(\xi-x)^2}{4a^2t}} d\xi \right| \\
&\leq \frac{\varepsilon}{3} \left(\frac{1}{2a\sqrt{\pi t}} \int_{x-\delta}^{x+\delta} e^{-\frac{(\xi-x)^2}{4a^2t}} d\xi \right) \\
&\leq \frac{\varepsilon}{3} \left(\frac{1}{2a\sqrt{\pi t}} \int_{-\infty}^{+\infty} e^{-\frac{(\xi-x)^2}{4a^2t}} d\xi \right) = \frac{\varepsilon}{3}.
\end{aligned}$$

又有

$$\begin{aligned}
|I_3| &= \left| \frac{1}{2a\sqrt{\pi t}} \int_{x+\delta}^{+\infty} [f(\xi) \right. \\
& \quad \left. - f(x)] e^{-\frac{(\xi-x)^2}{4a^2t}} d\xi \right| \\
&\leq \frac{1}{2a\sqrt{\pi t}} e^{-\frac{\delta^2}{4a^2t}} \int_{x+\delta}^{+\infty} |f(\xi)| d\xi \\
& \quad + \frac{|f(x)|}{2a\sqrt{\pi t}} \int_{x+\delta}^{+\infty} e^{-\frac{(\xi-x)^2}{4a^2t}} d\xi \\
&\leq \frac{1}{2a\sqrt{\pi t}} e^{-\frac{\delta^2}{4a^2t}} \int_{-\infty}^{+\infty} |f(\xi)| d\xi
\end{aligned}$$

$$+ \frac{|f(x)|}{\sqrt{\pi}} \int_{\frac{x}{2a\sqrt{t}}}^{+\infty} e^{-u^2} du,$$

由此可知 $\lim_{t \rightarrow +0} I_3 = 0$. 同理可证 $\lim_{t \rightarrow +0} I_1 = 0$. 于是, 存在 $\eta > 0$, 使当 $0 < t < \eta$ 时, 恒有

$$|I_3| < \frac{\varepsilon}{3}, \quad |I_1| < \frac{\varepsilon}{3}.$$

由此, 当 $0 < t < \eta$ 时, 恒有

$$|u(x, t) - f(x)| < \frac{\varepsilon}{3} + \frac{\varepsilon}{3} + \frac{\varepsilon}{3} = \varepsilon,$$

故 (7) 式成立. 证毕.

*) 编者注: 本题原书把 $\frac{\partial u}{\partial t} = a^2 \frac{\partial^2 u}{\partial x^2}$ 误写为

$\frac{\partial u}{\partial t} = \frac{1}{a^2} \frac{\partial^2 u}{\partial x^2}$. 另外, 原书只假定 $f(x)$ 在

$(-\infty, +\infty)$ 上绝对可积, 这是不够的. 应加上假定 $f(x)$ 在 $(-\infty, +\infty)$ 上连续. 否则, 结论

$$\lim_{t \rightarrow +0} u(x, t) = f(x)$$

就可能不成立了. 例如, 令

$$f(x) = \begin{cases} 1, & \text{当 } x = 0 \text{ 时;} \\ 0, & \text{当 } x \neq 0 \text{ 时,} \end{cases}$$

则显然 $f(x)$ 在 $(-\infty, +\infty)$ 绝对可积. 这时

$$u(x, t) \equiv 0 \quad (t > 0, -\infty < x < +\infty),$$

故 $\lim_{t \rightarrow +0} u(0, t) = 0 \neq 1 = f(0)$.

原
书
缺
页

709-740

第六章 多变量函数的微分法

§1. 多变量函数的极限. 连续性

1° 多变量函数的极限 设函数 $f(P) = f(x_1, x_2, \dots, x_n)$ 在以 P_0 为聚点的集合 E 上有定义. 若对于任何的 $\varepsilon > 0$ 存在有 $\delta = \delta(\varepsilon, P_0) > 0$, 使得只要 $P \in E$ 及 $0 < \rho(P, P_0) < \delta$ (其中 $\rho(P, P_0)$ 为 P 和 P_0 二点间的距离), 则

$$|f(P) - A| < \varepsilon,$$

我们就说

$$\lim_{P \rightarrow P_0} f(P) = A.$$

2° 连续性 若

$$\lim_{P \rightarrow P_0} f(P) = f(P_0),$$

则称函数 $f(P)$ 于 P_0 点是连续的.

若函数 $f(P)$ 于已知域内的每一点连续, 则称函数 $f(P)$ 于此域内是连续的.

3° 一致连续性 若对于每一个 $\varepsilon > 0$ 都存在有仅与 ε 有关的 $\delta > 0$, 使得对于域 G 中的任何点 P', P'' , 只要是

$$\rho(P', P'') < \delta,$$

便有不等式

$$|f(P') - f(P'')| < \varepsilon$$

成立, 则称函数 $f(P)$ 于域 G 内是一致连续的.

于有界闭域内的连续函数于此域内是一致连续的。

确定并绘出下列函数存在的域：

3136. $u = x + \sqrt{y}$.

解 存在域为半平面，

$$y \geq 0,$$

如图 6.1 阴影部分所示，包括整个 Ox 轴在内。



图 6.1

3137. $u = \sqrt{1-x^2}$

$$+ \sqrt{y^2-1}.$$

解 存在域为满足不等式

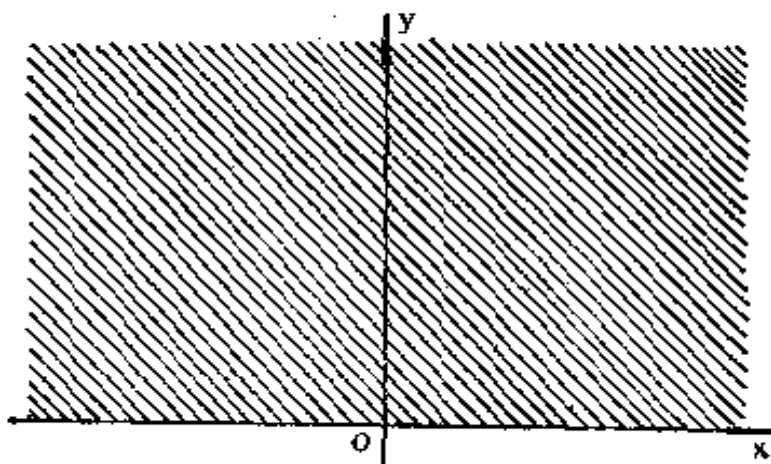
$$|x| \leq 1, |y| \geq 1$$

的点集，如图 6.2 阴影部分所示，包括边界（粗实线）在内。



图 6.2

3138. $u = \sqrt{1-x^2-y^2}$.

解 存在域为圆

$$x^2 + y^2 \leq 1,$$

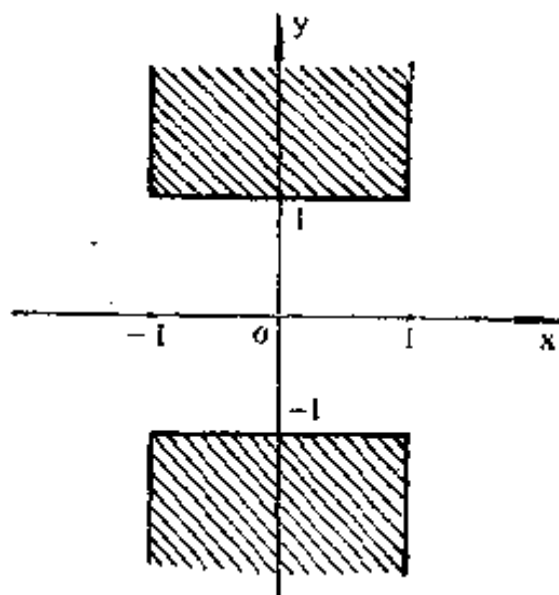
如图 6.3 阴影部分所示, 包括圆周在内.

3139. $u = \frac{1}{\sqrt{x^2 + y^2 - 1}}$.

解 存在域为满足不等式

$$x^2 + y^2 > 1$$

的点集, 即圆 $x^2 + y^2 = 1$ 的外面, 如图 6.4 所示, 不包括圆周 (虚线) 在内.

3140. $u = \frac{1}{\sqrt{(x^2 + y^2 - 1)(4 - x^2 - y^2)}}$.

解 存在域为满足不等式

$$1 \leq x^2 + y^2 \leq 4$$

的点集, 如图 6.5 所示的环, 包括边界在内.

3141. $u = \sqrt{\frac{x^2 + y^2 - x}{2x - x^2 - y^2}}$.

解 存在域为满足不等式

$$x \leq x^2 + y^2 < 2x$$

的点集. 由 $x^2 + y^2$



图 6.3



图 6.4

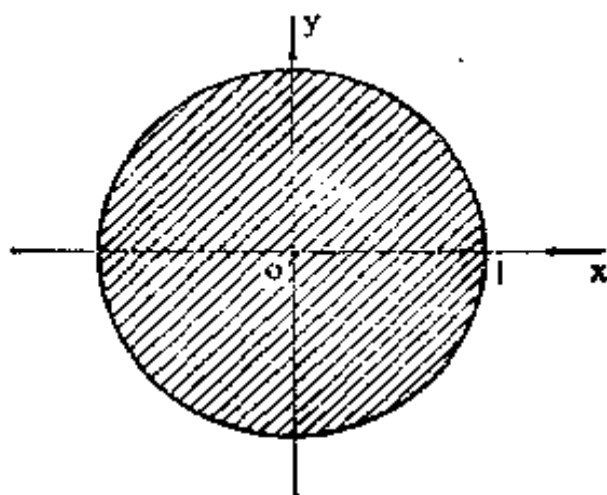

图 6.5

$\geq x$ 得出

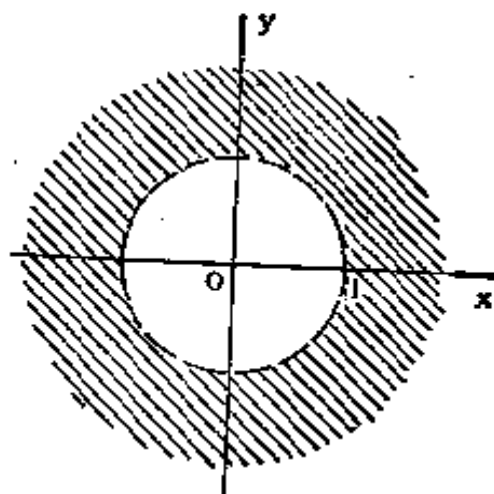
$$\left(x - \frac{1}{2}\right)^2 + y^2 \geq \left(\frac{1}{2}\right)^2,$$

由 $x^2 + y^2 < 2x$ 得出

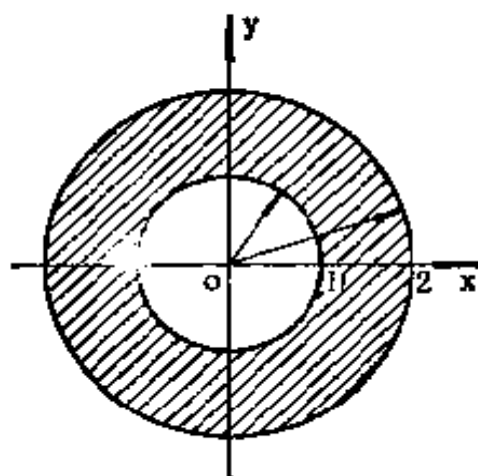
$$(x-1)^2 + y^2 < 1,$$

两者组成一月形, 如图 6.6 阴影部分所示.



图 6.6

3142. $u = \sqrt{1 - (x^2 + y)^2}$.

解 存在域为满足不等式

$$-1 \leq x^2 + y \leq 1$$

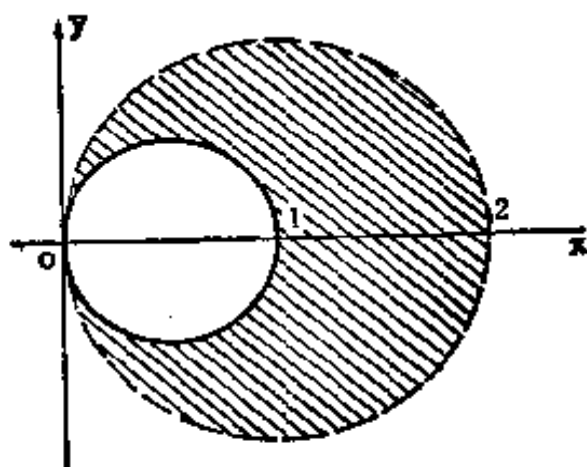
的点集, 如图 6.7 阴影部分所示, 包括边界在内.



图 6.7

3143. $u = \ln(-x - y)$.

解 存在域为半平面

$$x + y < 0,$$

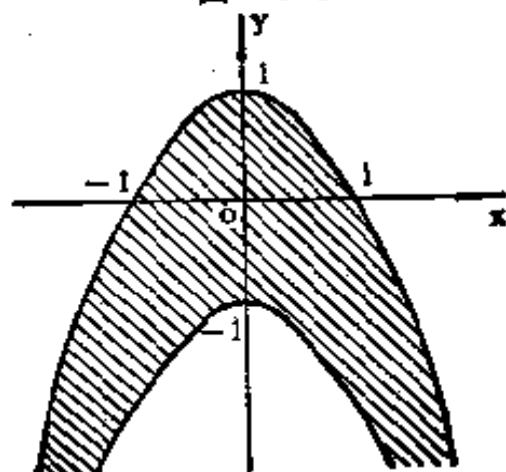
如图 6.8 阴影部分所示, 不包括直线 $x + y = 0$ 在内.



图 6.8

3144. $u = \arcsin \frac{y}{x}$.

解 存在域为满足

不等式

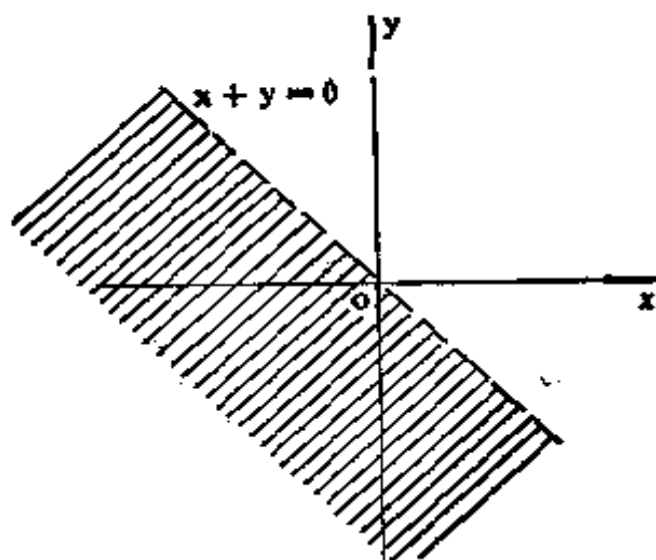
$$\left| \frac{y}{x} \right| \leq 1$$

或 $|y| \leq |x|$ ($x \neq 0$)
 的点集，这是一对对顶的直角，如图 6·9 阴影部分所示，不包括原点在内。



图 6·9

3145. $u = \arccos \frac{x}{x+y}$

解 存在域为满足不等式

$$\left| \frac{x}{x+y} \right| \leq 1$$

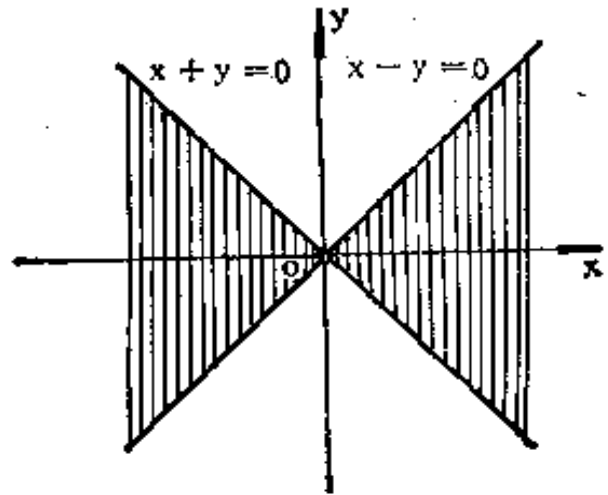
的点集。由 $\left| \frac{x}{x+y} \right| \leq 1$ 得 $|x| \leq |x+y|$ ($x \neq -y$),

即 $x^2 \leq x^2 + 2xy + y^2$ 或 $y(y+2x) \geq 0$ ，也即

$$\begin{cases} y \geq 0, \\ y \geq -2x, \end{cases} \quad \text{或} \quad \begin{cases} y \leq 0, \\ y \leq -2x. \end{cases}$$

但 x, y 不能同时为零。这是由直线： $y = 0$ 和 $y = -2x$ 所围成的一对对顶的角，如图 6·10 阴影部分所示，包括边界在内，但不包括公共顶点 $O(0,0)$ 在内。



图 6·10

3146. $u = \arcsin \frac{x}{y^2} + \arcsin(1 - y)$.

解 存在域为满足不等式

$$\left| \frac{x}{y^2} \right| \leq 1 \text{ 及 } |1 - y| \leq 1 \text{ (} y \neq 0 \text{)}$$

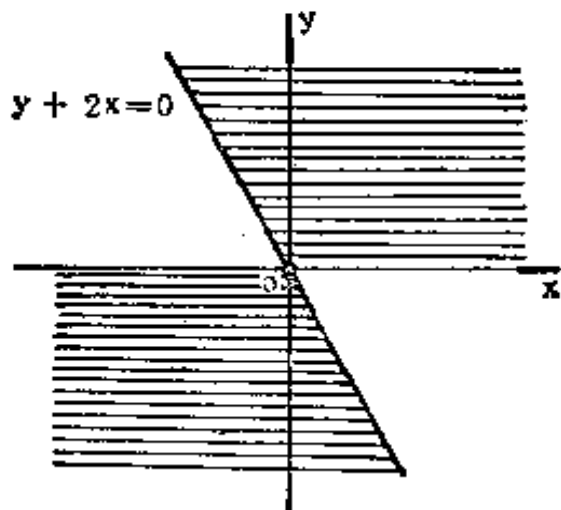
的点集, 即

$$\begin{cases} y^2 \geq x, \\ 0 < y \leq 2 \end{cases} \text{ 和}$$

$$\begin{cases} y^2 \geq -x, \\ 0 < y \leq 2. \end{cases}$$

这是由抛物线:

$$y^2 = x, \quad y^2 = -x$$

和直线 $y = 2$ 所围成的曲边三角形, 如图6·11阴影部分所示, 不包括原点在内.



图 6·11

3147. $u = \sqrt{\sin(x^2 + y^2)}$.

解 存在域为满足不等式

$$\sin(x^2 + y^2) \geq 0$$

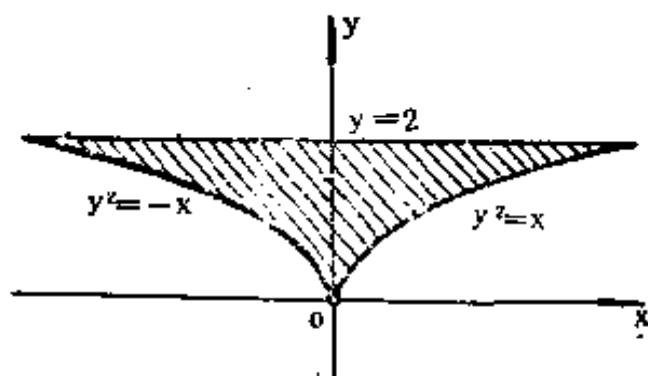
$$\text{或 } 2k\pi \leq x^2 + y^2$$

$$\leq (2k+1)\pi \text{ (} k$$

$= 0, 1, 2, \dots$) 的点集, 如图6·12所示的同心环族.



图 6·12

$$3148. u = \arccos \frac{z}{\sqrt{x^2 + y^2}}$$

解 存在域为满足不等式

$$\left| \frac{z}{\sqrt{x^2 + y^2}} \right| \leq 1$$

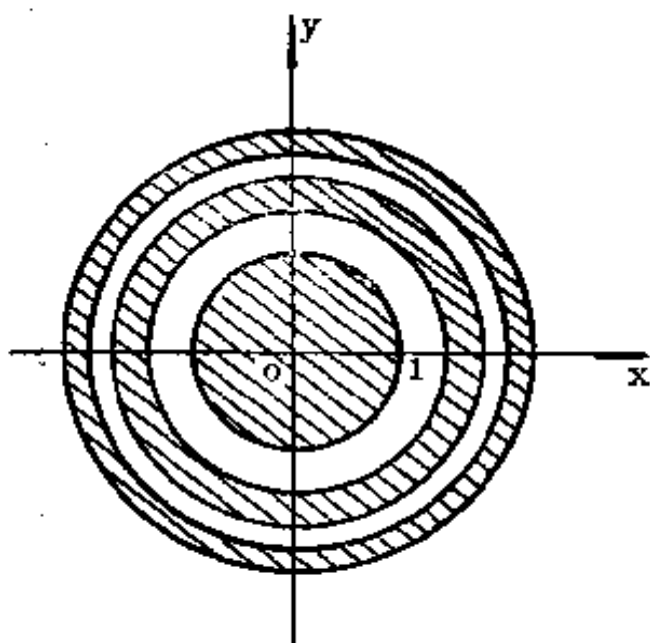
(x, y 不同时为零)

或

$$x^2 + y^2 - z^2 \geq 0$$

(x, y 不同时为零)



图 6·13

的点集，这是圆锥 $x^2 + y^2 - z^2 = 0$ 的外面，如图 6·13 阴影部分所示，包括边界在内，但要除去圆锥的顶点。

$$3149. u = \ln(xyz).$$

解 存在域为满足不等式

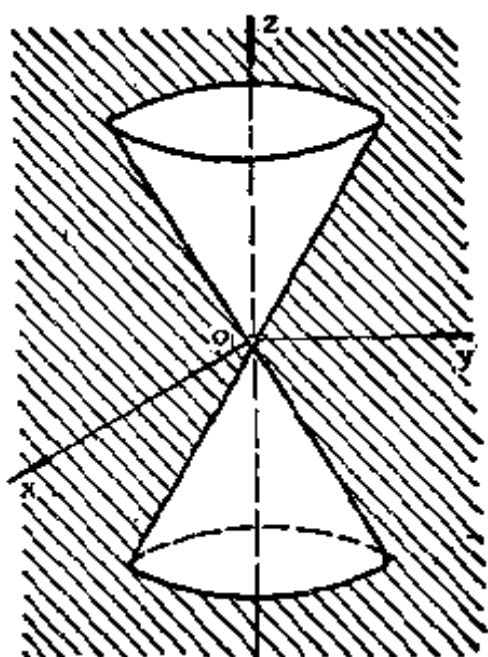
$$xyz > 0$$

的点集，即

$$x > 0, y > 0, z > 0; \text{ 或 } x > 0, y < 0, z < 0;$$

$$x < 0, y < 0, z > 0; \text{ 或 } x < 0, y > 0, z < 0.$$

其图形为空间第一、第三、第六及第八卦限的总体，但不包括坐标面。由于图形为读者所熟知，故省略。以下有类似情况，不再说明。

$$3150. u = \ln(-1 - x^2 - y^2 + z^2).$$

解 存在域为满足不等式

$$-x^2 - y^2 + z^2 > 1$$

的点集。这是双叶双曲面 $x^2 + y^2 - z^2 = -1$ 的内部，如图6·14阴影部分所示，不包括界面在内。

作出下列函数的等位线：



图 6·14

3151. $z = x + y$.

解 等位线为平行直线族

$$x + y = k,$$

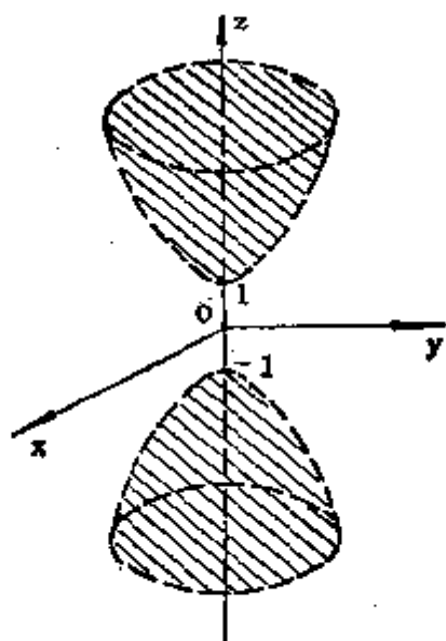
其中 k 为一切实数，如图6·15所示。

3152. $z = x^2 + y^2$.

解 等位线为曲线族

$$x^2 + y^2 = a^2$$

$$(a \geq 0).$$

当 $a = 0$ 时为原点；当 $a > 0$ 时，等位线为以原点为圆心的同心圆族。



图 6·15

3153. $z = x^2 - y^2$.

解 等位线为曲线族

$$x^2 - y^2 = k.$$

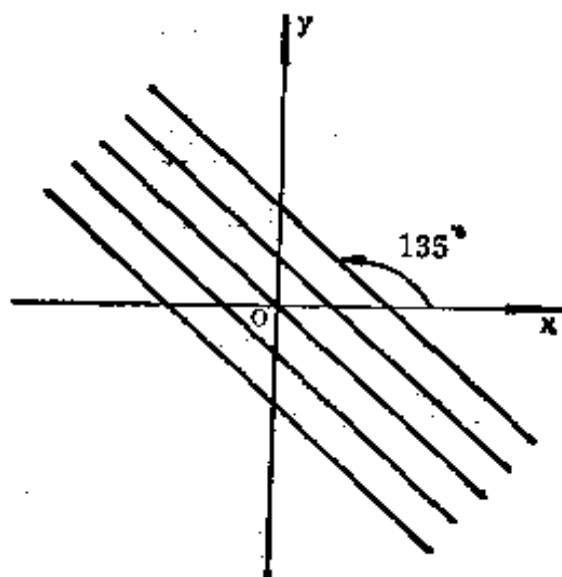
当 $k = 0$ 时为两条互相垂直的直线： $y = x, y = -x$ 。

当 $k \neq 0$ 时为以 $y = \pm x$ 为公共渐近线的等边双曲线族, 其中当 $k > 0$ 时顶点为 $(-\sqrt{k}, 0), (\sqrt{k}, 0)$, 当 $k < 0$ 时顶点为 $(0, -\sqrt{-k}), (0, \sqrt{-k})$.

3154. $z = (x + y)^2$.

解 等位线为曲线族

$$(x + y)^2 = a^2 \quad (a \geq 0).$$

当 $a = 0$ 为直线 $x + y = 0$. 当 $a \neq 0$ 时为与直线 $x + y = 0$ 平行的且等距的直线 $x + y = \pm a$.

3155. $z = \frac{y}{x}$.

解 等位线为以坐标原点为束心的直线束

$$y = kx \quad (x \neq 0),$$

不包括 Oy 轴在内.

3156. $z = \frac{1}{x^2 + 2y^2}$.

解 等位线为椭圆族

$$x^2 + 2y^2 = a^2 \quad (a > 0).$$

长半轴为 a , 短半轴为 $\frac{a}{\sqrt{2}}$, 焦点为 $(-a\sqrt{\frac{3}{2}}, 0)$

及 $(a\sqrt{\frac{3}{2}}, 0)$.

3157. $z = \sqrt{xy}$.

解 等位线为曲线族

$$xy = a^2 \quad (a \geq 0).$$

当 $a = 0$ 时为坐标轴 $x = 0$ 及 $y = 0$. 当 $a > 0$ 时为以两坐标轴为公共渐近线且位于第一、第三象限内的等

边双曲线族，顶点为 $(-a, -a)$ 及 (a, a) 。

3158. $z = |x| + y$.

解 等位线为曲线族

$$|x| + y = k,$$

其中 k 为一切实数。当

$x \geq 0$ 时为 $x + y = k$;

当 $x < 0$ 时为 $-x + y$

$= k$ 。这是顶点在 Oy

轴上两支互相垂直的

射线所构成的折线

族，如图 6·16 所示。



图 6·16

3159. $z = |x| + |y| - |x + y|$.

解 等位线为曲线族

$$|x| + |y| - |x + y| = a.$$

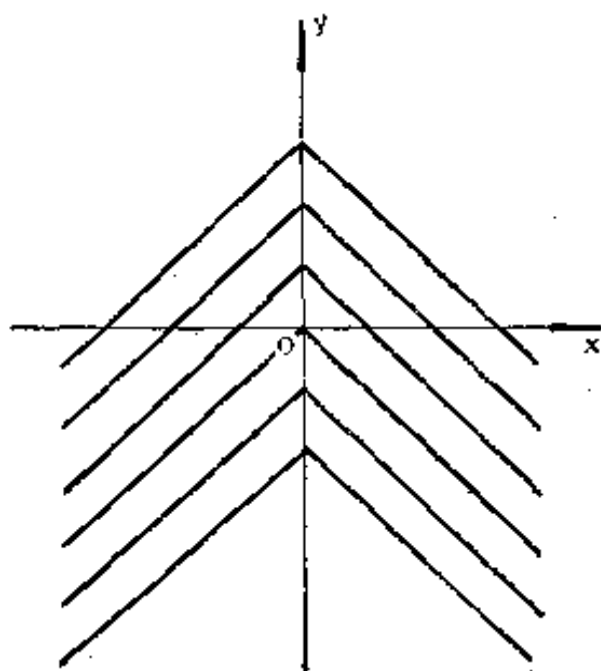
因为恒有 $|x| + |y| \geq |x + y|$ ，所以 $a \geq 0$ 。

当 $a = 0$ 时，由 $|x| + |y| = |x + y|$ 两边平方即得

$$xy \geq 0,$$

即为整个第一、第三象限，包括两坐标轴在内。

当 $a > 0$ 时， $xy < 0$ ，分下面四组求解：

(1) $x > 0, y < 0, x + y \geq 0, |x| + |y| - |x + y|$

$= a$ ，解之得 $y = -\frac{a}{2}$;

(2) $x > 0, y < 0, x + y \leq 0, |x| + |y| - |x + y|$

$= a$ ，解之得 $x = \frac{a}{2}$;

$$(3) \quad x < 0, y > 0, x + y \geq 0, |x| + |y| - |x + y| = a, \text{解之得 } x = -\frac{a}{2};$$

$$(4) \quad x < 0, y > 0, x + y \leq 0, |x| + |y| - |x + y| = a, \text{解之得 } y = \frac{a}{2}.$$

这是顶点位于直线 $x + y = 0$ 上的两支互相垂直的折线族，它的各射线平行于坐标轴，如图 6.17 所示。



图 6.17

3160. $z = e^{\frac{2x}{x^2 + y^2}}$

解 等位线为曲线族

$$\frac{2x}{x^2 + y^2} = k \quad (x, y \text{ 不同时为零}),$$

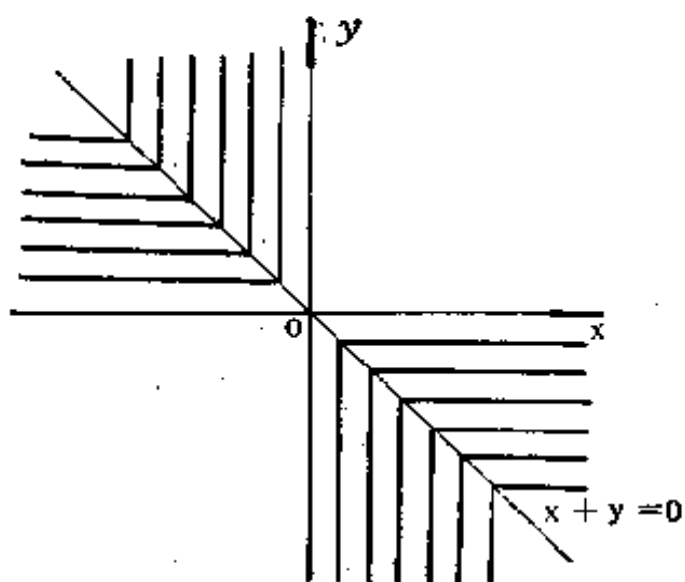
其中 k 为异于零的一切实数。上式可变形为

$$\left(x - \frac{1}{k}\right)^2 + y^2 = \left(\frac{1}{k}\right)^2 \quad (k \neq 0).$$

当 $k = 0$ 时，即得 $e^{\frac{2x}{x^2 + y^2}} = 1$ ，从而等位线为 $x = 0$ 即 Oy 轴，但不包括原点。

当 $k \neq 0$ 时为 中心在 Ox 轴上且 经过坐标原点 (但不包括原点在 内) 的 圆束, 圆心在 $(\frac{1}{k}, 0)$, 半径为 $|\frac{1}{k}|$,

如图 6.18 所示.



图 6.18

3161. $z = x^a \ (x > 0)$.

解 等位线为曲线族

$$x^a = a \ (a > 0).$$

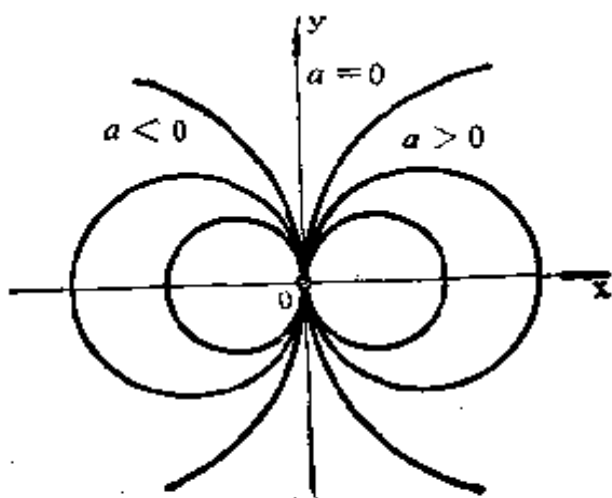
当 $a = 1$ 时为直线 $x = 1$ 及 Ox 轴的正向半射线, 但不包括原点在 内.

当 $0 < a < 1$ 与 $a > 1$ 时的图象如图 6.19 所示.



图 6.19

3162. $z = x^a e^{-x} \ (x > 0)$.

解 等位线为曲线族

$$x^y e^{-x} = a \quad (a > 0),$$

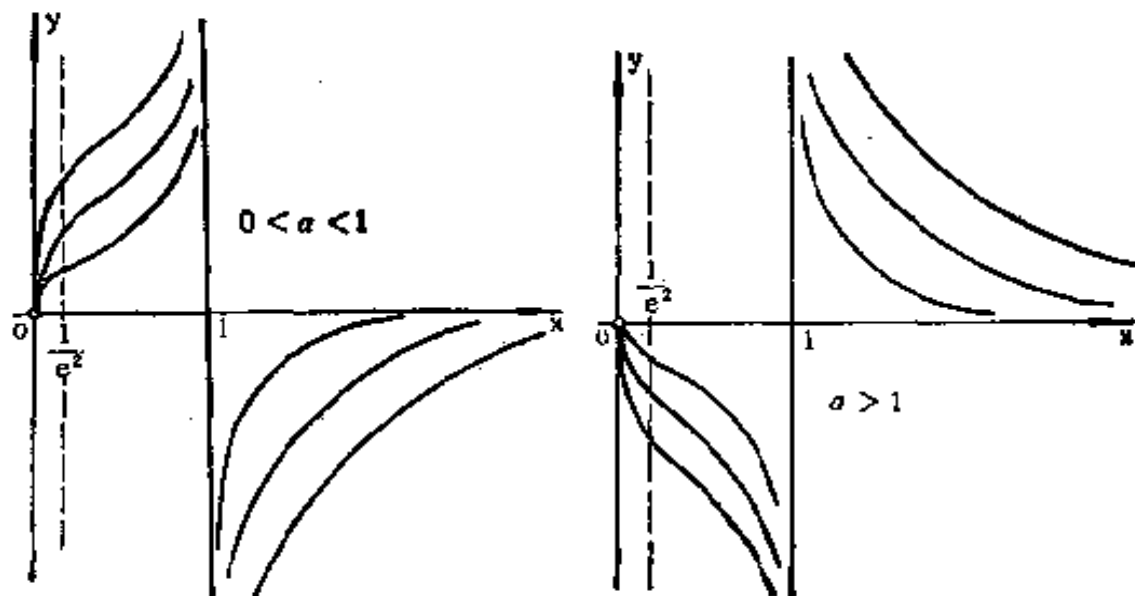
即

$$y \ln x - x = \ln a.$$

当 $a = e^{-1}$ 时为直线 $x = 1$

和曲线 $y = \frac{x-1}{\ln x}$; 当 $0 < a$

$< \frac{1}{e}$, $\frac{1}{e} < a < 1$ 或 $a \geq 1$ 时

图象布满整个右半平面, 如图 6.20 所示, 不包括 Oy 轴.



图 6.20

3163. $z = \ln \sqrt{\frac{(x-a)^2 + y^2}{(x+a)^2 + y^2}} \quad (a > 0).$

解 等位线为曲线族

$$\frac{(x-a)^2 + y^2}{(x+a)^2 + y^2} = k^2 \quad (k > 0).$$

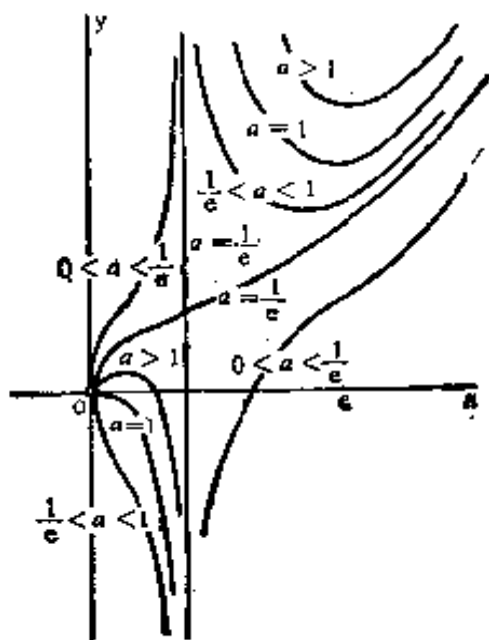
整理得

$$(1-k^2)x^2 - 2a(1+k^2)x + (1-k^2)a^2 + (1-k^2)y^2 = 0.$$

当 $k = 1$ 时得 $x = 0$, 即 Oy 轴. 当 $k \neq 1$ 时, 上述方程可变形为

$$\left[x - \frac{a(1+k^2)}{1-k^2} \right]^2 + y^2 = \left(\frac{2ak}{1-k^2} \right)^2,$$

这是以点 $\left(\frac{a(1+k^2)}{1-k^2}, 0 \right)$ 为圆心, 半径为 $\left| \frac{2ak}{1-k^2} \right|$

的圆族. 当 $0 < k < 1$ 时, 圆分布在右半平面; 当 $k > 1$ 时, 圆分布在左半平面.

如果注意到圆心与原点距离的平方为

$$\left[\frac{a(1+k^2)}{1-k^2} \right]^2 = \frac{a^2[(1-k^2)^2 + 4k^2]}{(1-k^2)^2}$$

$$= a^2 + \left(\frac{2ak}{1-k^2} \right)^2,$$

即等位线圆族与圆 $x^2 + y^2 = a^2$ 在交点处的半径互相垂直 (或圆心距与两圆的半径构成直角三角形), 便知等位线圆族与圆 $x^2 + y^2 = a^2$ 成正交. 如图 6·21 所示.



图 6·21

3164. $z = \operatorname{arc} \operatorname{tg} \frac{2ay}{x^2 + y^2 - a^2} \quad (a > 0).$

解 等位线为曲线族

$$\frac{2ay}{x^2 + y^2 - a^2} = k,$$

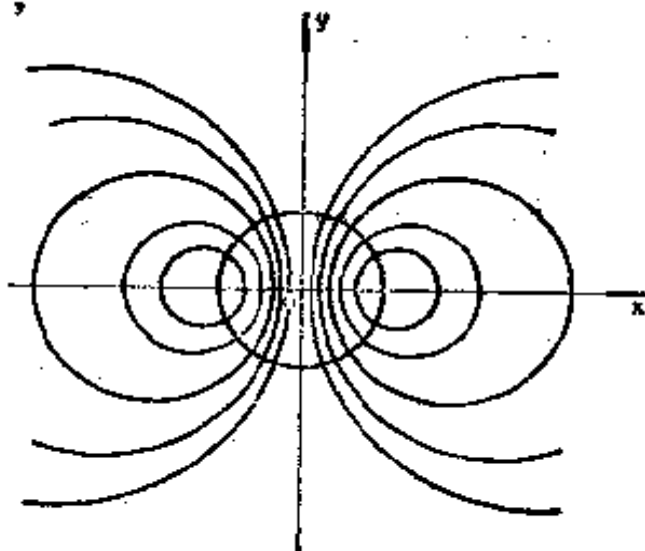
其中 k 为一切实数, 但要除去点 $(-a, 0)$ 及 $(a, 0)$. 当 $k=0$ 时, $y=0$, 即为 Ox 轴, 但不包含上述两点; 当 $k \neq 0$ 时, 方程可变形为

$$x^2 + \left(y - \frac{a}{k}\right)^2 = a^2 \left(1 + \frac{1}{k^2}\right),$$

这是圆心在 Oy 轴上且经过点 $(-a, 0)$ 及 $(a, 0)$ 但不包括这两点在内的圆族, 如图 6.22 所示.



图 6.22

3165. $z = \operatorname{sgn}(\sin x \sin y)$.

解 若 $z = 0$, 则 $\sin x \cdot \sin y = 0$, 此即直线族

$$x = m\pi \text{ 和 } y = n\pi \quad (m, n = 0, \pm 1, \pm 2, \dots);$$

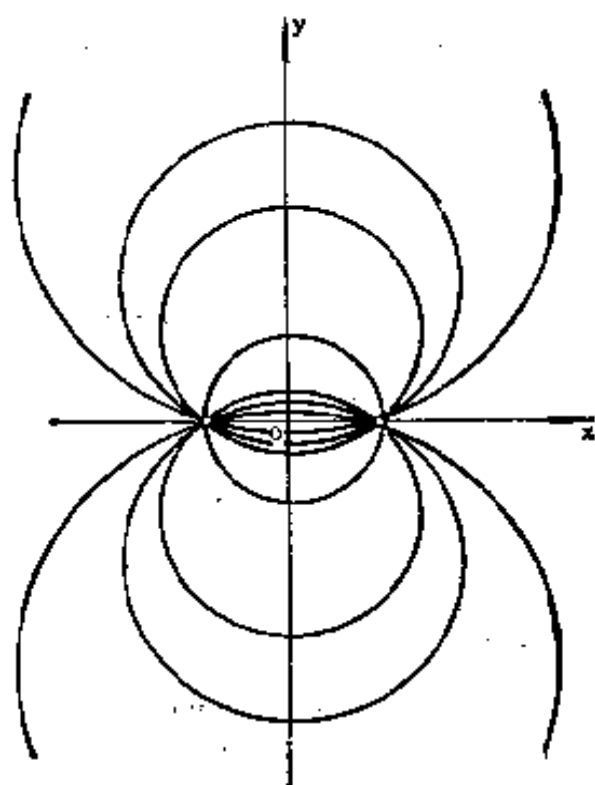
若 $z = -1$ 或 $z = 1$, 则 $\sin x \sin y < 0$ 或 $\sin x \sin y > 0$, 此即正方形系

$$m\pi < x < (m+1)\pi, \quad n\pi < y < (n+1)\pi,$$

其中 $z = (-1)^{m+n}$.

如图 6.23 所示, $z = 0$ 时为图中网格直线; $z = 1$ 为图中带斜线的正方形; $z = -1$ 为图中空白正方形, 但后两者都不包括边界.



图 6.23

求下列函数的等位

面。

3166. $u = x + y + z.$

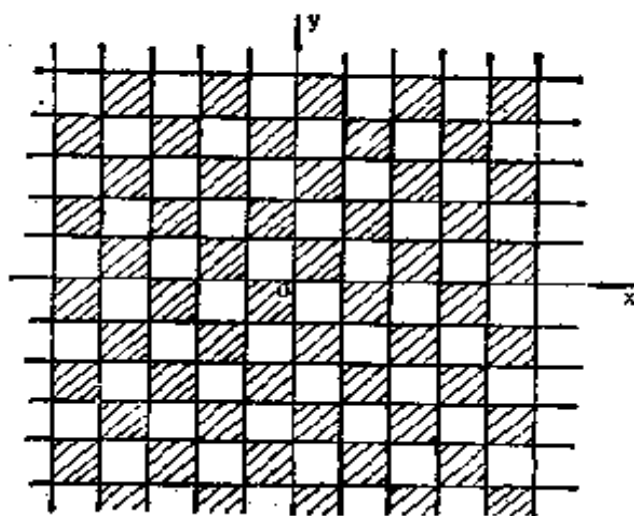
解 等位面为平行平面族

$$x + y + z = k,$$

其中 k 为一切实数。

3167. $u = x^2 + y^2 + z^2.$

解 等位面为中心在原点的同心球族

$$x^2 + y^2 + z^2 = a^2 \quad (a \geq 0),$$

其中当 $a = 0$ 时即为原点。

3168. $u = x^2 + y^2 - z^2.$

解 当 $u = 0$ 时等位面为圆锥 $x^2 + y^2 - z^2 = 0$ ；当 $u > 0$ 时等位面为单叶双曲面族 $x^2 + y^2 - z^2 = a^2$ ($a > 0$)；当 $u < 0$ 时等位面为双叶双曲面族 $-x^2 - y^2 + z^2 = a^2$ ($a > 0$)。

3169. $u = (x + y)^2 + z^2.$

解 等位面为曲面族

$$(x + y)^2 + z^2 = a^2 \quad (a \geq 0).$$

当 $a = 0$ 时为 $x + y = 0$ 和 $z = 0$ 。当 $a > 0$ 时作坐标变换

$$\begin{cases} x' = x \cos \frac{\pi}{4} + y \sin \frac{\pi}{4} = \frac{\sqrt{2}}{2}(x + y), \\ y' = -x \sin \frac{\pi}{4} + y \cos \frac{\pi}{4} = \frac{\sqrt{2}}{2}(-x + y), \\ z' = z, \end{cases}$$

这是旋转变换。在新坐标系中原等位面方程转化为

$$2x'^2 + z'^2 = a^2,$$

即

$$\frac{x'^2}{\frac{a^2}{2}} + \frac{z'^2}{a^2} = 1,$$

这是以 y' 轴为公共轴的椭圆柱面, 母线的方向平行于 y' 轴, 准线为 $y' = 0$ 平面上的椭圆

$$\frac{x'^2}{\frac{a^2}{2}} + \frac{z'^2}{a^2} = 1,$$

长半轴为 a (z' 轴方向), 短半轴为 $\frac{a}{\sqrt{2}}$ (x' 轴方向)。

y' 轴在新系 $O-x'y'z'$ 中的方程为

$$\begin{cases} x' = 0, \\ z' = 0, \end{cases}$$

而在旧系 $O-xyz$ 中的方程为

$$\begin{cases} x + y = 0, \\ z = 0, \end{cases}$$

即为所求的椭圆柱面族的公共对称轴。

3170. $u = \operatorname{sgn} \sin(x^2 + y^2 + z^2)$.

解 当 $u = 0$ 时等位面为球心在原点的同心球族

$$x^2 + y^2 + z^2 = n\pi \quad (n = 0, 1, 2, \dots).$$

当 $u = -1$ 或 $u = 1$ 时等位面为球层族

$$n\pi < x^2 + y^2 + z^2 < (n+1)\pi \quad (n = 0, 1, 2, \dots),$$

其中 $u = (-1)^n$.

根据曲面的已知方程研究其性质:

3171. $z = f(y - ax)$.

解 引入参数 t, s , 将曲面方程 $z = f(y - ax)$ 表成参数方程

$$\begin{cases} x = t, \\ y = at + s, \\ z = f(s). \end{cases}$$

今固定 s , 得到以 t 为参数的直线方程, 其方向数为 $1, a, 0$. 因此, 曲面为以 $1, a, 0$ 为母线方向的一个柱面. 令 $t = 0$, 可得

$$\begin{cases} x = 0, \\ y = s, \\ z = f(s), \end{cases} \quad \text{或} \quad \begin{cases} x = 0, \\ z = f(y), \end{cases}$$

这是 $x = 0$ 平面上的一条曲线, 也是柱面

$$z = f(y - ax)$$

的一条准线.

3172. $z = f(\sqrt{x^2 + y^2})$.

解 这是绕 Oz 轴旋转的旋转曲面的标准形式. 令 $y = 0$, 得曲线

$$\begin{cases} y = 0, \\ z = f(x) \quad (x \geq 0), \end{cases}$$

它是旋转曲面的一条母线.

3173. $z = xf\left(\frac{y}{x}\right)$.

解 引入参数 t, s , 将曲面方程 $z = xf\left(\frac{y}{x}\right)$ 表成参数方程

$$\begin{cases} x = t, \\ y = st (t \neq 0), \\ z = tf(s). \end{cases}$$

今固定 s , 这是以 t 为参数的一条过原点的直线. 因此, 所给曲面为顶点在原点的一锥面, 但不包括原点在内. 令 $t=1$, 得曲线

$$\begin{cases} x = 1, \\ y = s, \\ z = f(s), \end{cases} \quad \text{或} \quad \begin{cases} x = 1, \\ z = f(y), \end{cases}$$

这是 $x=1$ 平面上的一条曲线, 也是锥面 $z = xf\left(\frac{y}{x}\right)$ 的一条准线.

3174⁺. $z = f\left(\frac{y}{x}\right)$.

解 引入参数 t, s , 将曲面方程 $z = f\left(\frac{y}{x}\right)$ 表成参数方程

$$\begin{cases} x = t, \\ y = st, \\ z = f(s). \end{cases}$$

* 题号右上角“+”号表示题解答案与原习题集中译本所附答案不一致, 以后不再说明. 中译本基本是按俄文第二版翻译的. 俄文第二版中有一些错误已在俄文第三版中改正.

今固定 s , 这是一条过点 $(0, 0, f(s))$ 的直线, 方向数为 $1, s, 0$. 因此, 它与 Oz 轴垂直, 与 Oxy 平面平行, 且其方向与 s 有关. 从而得知, 曲面 $z = f\left(\frac{y}{x}\right)$ 表示一个直纹面. 一般说来, 它既不是柱面, 又不是锥面. 令 $t = 1$, 得到直纹面的一条准线

$$\begin{cases} x = 1, \\ z = f(y). \end{cases}$$

从此曲线上每一点引一条与 Oz 轴垂直且相交的直线. 这样的直线的全体, 便构成由 $z = f\left(\frac{y}{x}\right)$ 所表示的直纹面.

3175. 作出函数

$$F(t) = f(\cos t, \sin t)$$

的图形, 式中

$$f(x, y) = \begin{cases} 1, & \text{若 } y \geq x, \\ 0, & \text{若 } y < x. \end{cases}$$

解 按题设, 当 $\sin t \geq \cos t$, 即 $\frac{\pi}{4} + 2k\pi \leq t \leq \frac{5\pi}{4} + 2k\pi$ ($k = 0, \pm 1, \pm 2, \dots$) 时, $F(t) = 1$; 而当



图 6.24

$\sin t < \cos t$, 即 $-\frac{3}{4}\pi + 2k\pi < t < \frac{\pi}{4} + 2k\pi$ 时, $F(t) = 0$. 如图 6.24 所示.

3176. 若

$$f(x, y) = \frac{2xy}{x^2 + y^2},$$

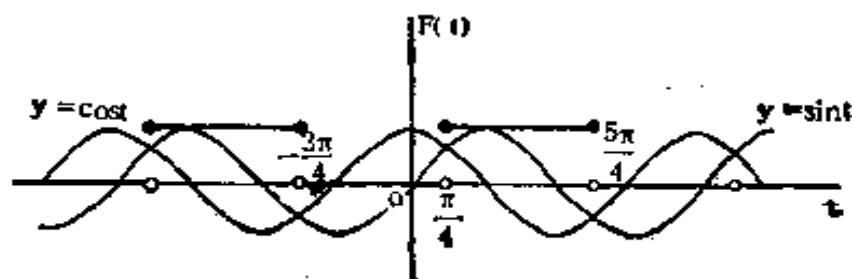
求 $f(1, \frac{y}{x})$.

$$\text{解 } f(1, \frac{y}{x}) = \frac{2 \cdot 1 \cdot \frac{y}{x}}{1 + (\frac{y}{x})^2} = \frac{2xy}{x^2 + y^2} = f(x, y).$$

3177. 若

$$f(\frac{y}{x}) = \frac{\sqrt{x^2 + y^2}}{x} \quad (x > 0),$$

求 $f(x)$.

$$\text{解 } \text{由 } f(\frac{y}{x}) = \sqrt{1 + (\frac{y}{x})^2} \text{ 知 } f(x) = \sqrt{1 + x^2}.$$

3178. 设

$$z = \sqrt{y} + f(\sqrt{x} - 1).$$

若当 $y=1$ 时 $z=x$, 求函数 f 和 z .

解 因为当 $y=1$ 时 $z=x$, 所以

$$\begin{aligned} f(\sqrt{x} - 1) &= x - 1 = (\sqrt{x} - 1)(\sqrt{x} + 1) \\ &= (\sqrt{x} - 1)[(\sqrt{x} - 1) + 2], \end{aligned}$$

从而得

$$f(t) = t(t+2) = t^2 + 2t,$$

且

$$z = \sqrt{y} + x - 1 \quad (x > 0).$$

3179. 设

$$z = x + y + f(x - y).$$

若当 $y=0$ 时, $z=x^2$, 求函数 f 及 z .

解 因为当 $y=0$ 时 $z=x^2$, 所以

$$x^2 = x + f(x),$$

即

$$f(x) = x^2 - x,$$

且

$$z = x + y + (x - y)^2 - (x - y) = 2y + (x - y)^2.$$

3180. 若 $f(x + y, \frac{y}{x}) = x^2 - y^2$, 求 $f(x, y)$.

解 因为

$$f(x + y, \frac{y}{x}) = x^2 - y^2 = (x + y)(x - y)$$

$$= (x + y)^2 \frac{x - y}{x + y} = (x + y)^2 \frac{1 - \frac{y}{x}}{1 + \frac{y}{x}},$$

所以

$$f(x, y) = x^2 \frac{1 - y}{1 + y}.$$

3181. 证明: 对于函数

$$f(x, y) = \frac{x - y}{x + y}$$

有

$$\lim_{x \rightarrow 0} \left\{ \lim_{y \rightarrow 0} f(x, y) \right\} = 1; \quad \lim_{y \rightarrow 0} \left\{ \lim_{x \rightarrow 0} f(x, y) \right\} = -1,$$

从而 $\lim_{\substack{x \rightarrow 0 \\ y \rightarrow 0}} f(x, y)$ 不存在.

$$\text{证} \quad \lim_{x \rightarrow 0} \left\{ \lim_{y \rightarrow 0} f(x, y) \right\} = \lim_{x \rightarrow 0} \left\{ \lim_{y \rightarrow 0} \frac{x-y}{x+y} \right\} = \lim_{x \rightarrow 0} \frac{x}{x} = 1,$$

$$\begin{aligned} \lim_{y \rightarrow 0} \left\{ \lim_{x \rightarrow 0} f(x, y) \right\} &= \lim_{y \rightarrow 0} \left\{ \lim_{x \rightarrow 0} \frac{x-y}{x+y} \right\} \\ &= \lim_{y \rightarrow 0} \frac{-y}{y} = -1. \end{aligned}$$

由于两个单极限都存在，而累次极限不等，故 $\lim_{\substack{x \rightarrow 0 \\ y \rightarrow 0}} f(x, y)$ 不存在.

3182. 证明：对于函数

$$f(x, y) = \frac{x^2 y^2}{x^2 y^2 + (x-y)^2}$$

有

$$\lim_{x \rightarrow 0} \left\{ \lim_{y \rightarrow 0} f(x, y) \right\} = \lim_{x \rightarrow 0} \left\{ \lim_{y \rightarrow 0} f(x, y) \right\} = 0,$$

然而 $\lim_{\substack{x \rightarrow 0 \\ y \rightarrow 0}} f(x, y)$ 不存在.

$$\begin{aligned} \text{证} \quad \lim_{x \rightarrow 0} \left\{ \lim_{y \rightarrow 0} f(x, y) \right\} &= \lim_{x \rightarrow 0} \left\{ \lim_{y \rightarrow 0} \frac{x^2 y^2}{x^2 y^2 + (x-y)^2} \right\} \\ &= \lim_{x \rightarrow 0} 0 = 0, \end{aligned}$$

$$\lim_{y \rightarrow 0} \left\{ \lim_{x \rightarrow 0} f(x, y) \right\} = \lim_{y \rightarrow 0} \left\{ \lim_{x \rightarrow 0} \frac{x^2 y^2}{x^2 y^2 + (x-y)^2} \right\} \\ = \lim_{y \rightarrow 0} 0 = 0.$$

如果按 $y = kx \rightarrow 0$ 的方向取极限, 则有

$$\lim_{\substack{y=kx \\ x \rightarrow 0}} f(x, y) = \lim_{x \rightarrow 0} \frac{x^4 k^2}{x^4 k^2 + x^2 (1-k)^2}.$$

特别地, 分别取 $k=0$ 及 $k=1$, 便得到不同的极限 0 及 1. 因此, $\lim_{\substack{x \rightarrow 0 \\ y \rightarrow 0}} f(x, y)$ 不存在.

3183. 证明: 对于函数

$$f(x, y) = (x+y) \sin \frac{1}{x} \sin \frac{1}{y}$$

累次极限 $\lim_{x \rightarrow 0} \left\{ \lim_{y \rightarrow 0} f(x, y) \right\}$ 和 $\lim_{y \rightarrow 0} \left\{ \lim_{x \rightarrow 0} f(x, y) \right\}$ 不存在, 然而 $\lim_{\substack{x \rightarrow 0 \\ y \rightarrow 0}} f(x, y) = 0$.

证 由不等式

$$0 \leq \left| (x+y) \sin \frac{1}{x} \sin \frac{1}{y} \right| \leq |x+y| \leq |x| + |y|$$

知 $\lim_{\substack{x \rightarrow 0 \\ y \rightarrow 0}} f(x, y) = 0$.

但当 $x \neq \frac{1}{k\pi}$, $y \rightarrow 0$ 时, $(x+y) \sin \frac{1}{x} \sin \frac{1}{y}$ 的极限不存在, 因此累次极限 $\lim_{x \rightarrow 0} \left\{ \lim_{y \rightarrow 0} f(x, y) \right\}$ 不存在. 同法可证累次极限 $\lim_{y \rightarrow 0} \left\{ \lim_{x \rightarrow 0} f(x, y) \right\}$ 也不存在.

3184. 求 $\lim_{x \rightarrow a} \left\{ \lim_{y \rightarrow b} f(x, y) \right\}$ 及 $\lim_{y \rightarrow b} \left\{ \lim_{x \rightarrow a} f(x, y) \right\}$, 设:

$$(a) f(x, y) = \frac{x^2 + y^2}{x^2 + y^4}, \quad a = \infty, \quad b = \infty;$$

$$(b) f(x, y) = \frac{x^y}{1 + x^y}, \quad a = +\infty, \quad b = +0;$$

$$(B) f(x, y) = \sin \frac{\pi x}{2x + y}, \quad a = \infty, \quad b = \infty;$$

$$(r) f(x, y) = \frac{1}{xy} \operatorname{tg} \frac{xy}{1 + xy}, \quad a = 0, \quad b = \infty;$$

$$(A) f(x, y) = \log_x(x + y), \quad a = 1, \quad b = 0.$$

$$\text{解 } (a) \lim_{x \rightarrow \infty} \left\{ \lim_{y \rightarrow \infty} f(x, y) \right\} = \lim_{x \rightarrow \infty} \left\{ \lim_{y \rightarrow \infty} \frac{x^2 + y^2}{x^2 + y^4} \right\} \\ = \lim_{x \rightarrow \infty} 0 = 0,$$

$$\lim_{y \rightarrow \infty} \left\{ \lim_{x \rightarrow \infty} f(x, y) \right\} = \lim_{y \rightarrow \infty} \left\{ \lim_{x \rightarrow \infty} \frac{x^2 + y^2}{x^2 + y^4} \right\} \\ = \lim_{y \rightarrow \infty} 1 = 1;$$

$$(b) \lim_{x \rightarrow +\infty} \left\{ \lim_{y \rightarrow +0} f(x, y) \right\} = \lim_{x \rightarrow +\infty} \left\{ \lim_{y \rightarrow +0} \frac{x^y}{1 + x^y} \right\}$$

$$= \lim_{x \rightarrow +\infty} \frac{1}{2} = \frac{1}{2},$$

$$\lim_{y \rightarrow +0} \left\{ \lim_{x \rightarrow +\infty} f(x, y) \right\} = \lim_{y \rightarrow +0} \left\{ \lim_{x \rightarrow +\infty} \frac{x^y}{1 + x^y} \right\}$$

$$= \lim_{y \rightarrow +0} 1 = 1;$$

$$(B) \lim_{x \rightarrow \infty} \left\{ \lim_{y \rightarrow \infty} f(x, y) \right\} = \lim_{x \rightarrow \infty} \left\{ \lim_{y \rightarrow \infty} \sin \frac{\pi x}{2x + y} \right\}$$

$$= \lim_{x \rightarrow \infty} 0 = 0,$$

$$\begin{aligned} \lim_{y \rightarrow \infty} \left\{ \lim_{x \rightarrow \infty} f(x, y) \right\} &= \lim_{y \rightarrow \infty} \left\{ \lim_{x \rightarrow \infty} \sin \frac{\pi x}{2x + y} \right\} \\ &= \lim_{y \rightarrow \infty} 1 = 1; \end{aligned}$$

$$\begin{aligned} (\Gamma) \quad \lim_{x \rightarrow 0} \left\{ \lim_{y \rightarrow \infty} f(x, y) \right\} &= \lim_{x \rightarrow 0} \left\{ \lim_{y \rightarrow \infty} \frac{1}{xy} \operatorname{tg} \frac{xy}{1 + xy} \right\} \\ &= \lim_{x \rightarrow 0} \left\{ \lim_{y \rightarrow \infty} \frac{1}{xy} \cdot \lim_{y \rightarrow \infty} \operatorname{tg} \frac{xy}{1 + xy} \right\} \\ &= \lim_{x \rightarrow 0} \left\{ 0 \cdot \operatorname{tg} 1 \right\} = 0, \end{aligned}$$

$$\begin{aligned} \lim_{y \rightarrow \infty} \left\{ \lim_{x \rightarrow 0} f(x, y) \right\} &= \lim_{y \rightarrow \infty} \left\{ \lim_{x \rightarrow 0} \frac{1}{xy} \operatorname{tg} \frac{xy}{1 + xy} \right\} \\ &= \lim_{y \rightarrow \infty} \left\{ \lim_{x \rightarrow 0} \frac{\operatorname{tg} \frac{xy}{1 + xy}}{\frac{xy}{1 + xy}} \cdot \lim_{x \rightarrow 0} \frac{1}{1 + xy} \right\} \\ &= \lim_{y \rightarrow \infty} 1 = 1; \end{aligned}$$

$$\begin{aligned} (\Delta) \quad \lim_{x \rightarrow 1} \left\{ \lim_{y \rightarrow 0} f(x, y) \right\} &= \lim_{x \rightarrow 1} \left\{ \lim_{y \rightarrow 0} \log_x (x + y) \right\} \\ &= \lim_{x \rightarrow 1} \left\{ \lim_{y \rightarrow 0} \frac{\ln(x + y)}{\ln x} \right\} = \lim_{x \rightarrow 1} \frac{\ln x}{\ln x} = 1, \end{aligned}$$

$$\lim_{y \rightarrow 0} \left\{ \lim_{x \rightarrow 1} f(x, y) \right\} = \lim_{y \rightarrow 0} \left\{ \lim_{x \rightarrow 1} \frac{\ln(x + y)}{\ln x} \right\} = \infty.$$

求下列极限:

$$3185. \lim_{\substack{x \rightarrow \infty \\ y \rightarrow \infty}} \frac{x+y}{x^2-xy+y^2}.$$

解 由不等式 $x^2+y^2 \geq 2|xy|$ 得

$$\begin{aligned} 0 &\leq \left| \frac{x+y}{x^2-xy+y^2} \right| \leq \frac{|x+y|}{x^2+y^2-|xy|} \leq \frac{|x+y|}{|xy|} \\ &\leq \frac{1}{|x|} + \frac{1}{|y|}, \end{aligned}$$

而 $\lim_{\substack{x \rightarrow \infty \\ y \rightarrow \infty}} \left(\frac{1}{|x|} + \frac{1}{|y|} \right) = 0$, 故有

$$\lim_{\substack{x \rightarrow \infty \\ y \rightarrow \infty}} \frac{x+y}{x^2-xy+y^2} = 0.$$

$$3186. \lim_{\substack{x \rightarrow \infty \\ y \rightarrow \infty}} \frac{x^2+y^2}{x^4+y^4}.$$

解 由不等式

$$0 \leq \frac{x^2+y^2}{x^4+y^4} \leq \frac{x^2+y^2}{2x^2y^2} = \frac{1}{2} \left(\frac{1}{x^2} + \frac{1}{y^2} \right)$$

及 $\lim_{\substack{x \rightarrow \infty \\ y \rightarrow \infty}} \frac{1}{2} \left(\frac{1}{x^2} + \frac{1}{y^2} \right) = 0$, 即得

$$\lim_{\substack{x \rightarrow \infty \\ y \rightarrow \infty}} \frac{x^2+y^2}{x^4+y^4} = 0.$$

$$3187. \lim_{\substack{x \rightarrow 0 \\ y \rightarrow a}} \frac{\sin xy}{x}.$$

解 $\lim_{\substack{x \rightarrow 0 \\ y \rightarrow a}} \frac{\sin xy}{x} = \lim_{\substack{x \rightarrow 0 \\ y \rightarrow a}} \left(\frac{\sin xy}{xy} \cdot y \right) = a.$

$$3188. \lim_{\substack{x \rightarrow +\infty \\ y \rightarrow +\infty}} (x^2 + y^2)e^{-(x+y)},$$

$$\text{解 } \lim_{\substack{x \rightarrow +\infty \\ y \rightarrow +\infty}} (x^2 + y^2)e^{-(x+y)}$$

$$= \lim_{\substack{x \rightarrow +\infty \\ y \rightarrow +\infty}} \left[\frac{(x+y)^2}{e^{x+y}} - 2 \cdot \frac{x}{e^x} \cdot \frac{y}{e^y} \right] = 0^*.$$

*) 利用 564 题的结果.

$$3189. \lim_{\substack{x \rightarrow +\infty \\ y \rightarrow +\infty}} \left(\frac{xy}{x^2 + y^2} \right)^{x^2}.$$

解 由不等式

$$0 \leq \left(\frac{xy}{x^2 + y^2} \right)^{x^2} \leq \left(\frac{1}{2} \right)^{x^2}$$

及 $\lim_{x \rightarrow +\infty} \left(\frac{1}{2} \right)^{x^2} = 0$, 即得

$$\lim_{\substack{x \rightarrow +\infty \\ y \rightarrow +\infty}} \left(\frac{xy}{x^2 + y^2} \right)^{x^2} = 0.$$

$$3190. \lim_{\substack{x \rightarrow 0 \\ y \rightarrow 0}} (x^2 + y^2)^{x^2 y^2}.$$

解 由不等式

$$|x^2 y^2 \ln(x^2 + y^2)| \leq \frac{(x^2 + y^2)^2}{4} |\ln(x^2 + y^2)|$$

及 $\lim_{\substack{x \rightarrow 0 \\ y \rightarrow 0}} \frac{(x^2 + y^2)^2}{4} \ln(x^2 + y^2) = \lim_{t \rightarrow 0} \frac{1}{4} t^2 \ln t = 0$, 即得

$$\lim_{\substack{x \rightarrow 0 \\ y \rightarrow 0}} (x^2 + y^2)^{x^2 y^2} = \lim_{\substack{x \rightarrow 0 \\ y \rightarrow 0}} e^{x^2 y^2 \ln(x^2 + y^2)} = e^0 = 1.$$

$$3191. \lim_{\substack{x \rightarrow \infty \\ y \rightarrow a}} \left(1 + \frac{1}{x}\right)^{\frac{x^2}{x+y}}$$

$$\begin{aligned} \text{解} \quad \lim_{\substack{x \rightarrow \infty \\ y \rightarrow a}} \left(1 + \frac{1}{x}\right)^{\frac{x^2}{x+y}} &= \lim_{\substack{x \rightarrow \infty \\ y \rightarrow a}} \left(1 + \frac{1}{x}\right)^{x \cdot \frac{x}{x+y}} \\ &= \lim_{\substack{x \rightarrow \infty \\ y \rightarrow a}} e^{[x \ln(1 + \frac{1}{x})] \cdot \frac{x}{x+y}} \\ &= e^{\left[\lim_{x \rightarrow \infty} x \ln\left(1 + \frac{1}{x}\right)\right] \cdot \left[\lim_{\substack{x \rightarrow \infty \\ y \rightarrow a}} \frac{x}{x+y}\right]} = e^{1 \cdot 1} = e. \end{aligned}$$

$$3192. \lim_{\substack{x \rightarrow 1 \\ y \rightarrow 0}} \frac{\ln(x + e^y)}{\sqrt{x^2 + y^2}}$$

$$\text{解} \quad \lim_{\substack{x \rightarrow 1 \\ y \rightarrow 0}} \frac{\ln(x + e^y)}{\sqrt{x^2 + y^2}} = \frac{\ln(1 + e^0)}{1} = \ln 2.$$

3193⁺. 若 $x = \rho \cos \varphi$, $y = \rho \sin \varphi$, 问下列极限沿怎样的方向 φ 有确定的极限值存在:

$$(a) \lim_{\rho \rightarrow +0} e^{\frac{x}{x^2 + y^2}}; \quad (b) \lim_{\rho \rightarrow +\infty} e^{x^2 - y^2} \cdot \sin 2xy.$$

$$\text{解} \quad (a) \lim_{\rho \rightarrow +0} e^{\frac{x}{x^2 + y^2}} = \lim_{\rho \rightarrow +0} e^{\frac{\cos \varphi}{\rho}}$$

$$= \begin{cases} 0, & \text{当 } \cos \varphi < 0; \\ 1, & \text{当 } \cos \varphi = 0; \\ +\infty, & \text{当 } \cos \varphi > 0. \end{cases}$$

于是, 仅当 $\cos \varphi \leq 0$ 即 $\frac{\pi}{2} \leq \varphi \leq \frac{3\pi}{2}$ 时, 所给的极限

才有确定的值.

$$(6) e^{x^2-y^2} \sin 2xy = e^{\rho^2 \cos 2\varphi} \sin(\rho^2 \sin 2\varphi).$$

当 $\rho \rightarrow +\infty$ 时, $\sin(\rho^2 \sin 2\varphi)$ 有界, 除 $\varphi = \frac{k\pi}{2}$

($k=0, 1, 2, 3$) 外无极限, 且

$$\lim_{\rho \rightarrow +\infty} e^{\rho^2 \cos 2\varphi} = \begin{cases} 0, & \text{当 } \cos 2\varphi < 0; \\ 1, & \text{当 } \cos 2\varphi = 0; \\ +\infty, & \text{当 } \cos 2\varphi > 0. \end{cases}$$

于是, 仅当 $\frac{\pi}{4} < \varphi < \frac{3\pi}{4}$ 及 $\frac{5\pi}{4} < \varphi < \frac{7\pi}{4}$ 以及 $\varphi=0, \varphi$

$=\pi$ 时才有确定的极限.

求下列函数的不连续点:

$$3194. u = \frac{1}{\sqrt{x^2 + y^2}}.$$

解 函数 $u = \frac{1}{\sqrt{x^2 + y^2}}$ 在点 $(0, 0)$ 无定义, 故原点

$(0, 0)$ 为此函数的不连续点. 以下各题类似情况, 不再说明.

$$3195. u = \frac{xy}{x+y}.$$

解 直线 $x+y=0$ 上的一切点均为 $u = \frac{xy}{x+y}$ 的不连续点.

$$3196. u = \frac{x+y}{x^3+y^3}.$$

解 对于任意不等于零的实数 a , 有

$$\lim_{\substack{x \rightarrow a \\ y \rightarrow -a}} \frac{x+y}{x^3+y^3} = \lim_{\substack{x \rightarrow a \\ y \rightarrow -a}} \frac{1}{x^2-xy+y^2} = \frac{1}{3a^2}.$$

于是，对于直线 $x+y=0$ 上除去原点 O 外的一切点均为可移去的不连续点。而原点 $O(0,0)$ 为无穷型不连续点。

3197. $u = \sin \frac{1}{xy}.$

解 $xy=0$ 上的一切点即两坐标轴上的诸点均为 $u = \sin \frac{1}{xy}$ 的不连续点。

3198. $u = \frac{1}{\sin x \sin y}.$

解 直线 $x=m\pi$ 及 $y=n\pi$ ($m, n=0, \pm 1, \pm 2, \dots$) 上的各点均为 $u = \frac{1}{\sin x \sin y}$ 的不连续点。

3199. $u = \ln(1-x^2-y^2).$

解 圆周 $x^2+y^2=1$ 上各点是 $u = \ln(1-x^2-y^2)$ 的不连续点。

3200. $u = \frac{1}{xyz}.$

解 坐标面： $x=0$ ， $y=0$ ， $z=0$ 上各点均为 $u = \frac{1}{xyz}$ 的不连续点。

3201. $u = \ln \frac{1}{\sqrt{(x-a)^2 + (y-b)^2 + (z-c)^2}}.$

解 点 (a, b, c) 为 $u = \ln \frac{1}{\sqrt{(x-a)^2 + (y-b)^2 + (z-c)^2}}$ 的不连续点.

3202. 证明: 函数

$$f(x, y) = \begin{cases} \frac{2xy}{x^2 + y^2}, & \text{若 } x^2 + y^2 \neq 0; \\ 0, & \text{若 } x^2 + y^2 = 0, \end{cases}$$

分别对于每一个变数 x 或 y (当另一变数的值固定时)是连续的, 但并非对这些变数的总体是连续的.

证 先固定 $y = a \neq 0$, 则得 x 的函数

$$g(x) = f(x, a) = \begin{cases} \frac{2ax}{x^2 + a^2}, & x \neq 0, \\ 0, & x = 0, \end{cases}$$

即 $g(x) = \frac{2ax}{x^2 + a^2}$ ($-\infty < x < +\infty$), 它是处处有定义的有理函数. 又当 $y = 0$ 时, $f(x, 0) \equiv 0$, 它显然是连续的. 于是, 当变数 y 固定时, 函数 $f(x, y)$ 对于变数 x 是连续的. 同理可证, 当变数 x 固定时, 函数 $f(x, y)$ 对于变数 y 是连续的.

作为二元函数, $f(x, y)$ 虽在除点 $(0, 0)$ 外的各点均连续, 但在点 $(0, 0)$ 不连续. 事实上, 当动点 $P(x, y)$ 沿射线 $y = kx$ 趋于原点时, 有

$$\lim_{\substack{x \rightarrow 0 \\ (y=kx)}} f(x, y) = \lim_{x \rightarrow 0} \frac{2kx^2}{x^2(1+k^2)} = \frac{2k}{1+k^2},$$

对于不同的 k 可得不同的极限值, 从而知 $\lim_{\substack{x \rightarrow 0 \\ y \rightarrow 0}} f(x, y)$ 不存在. 因此, 函数 $f(x, y)$ 在原点不是二元连续

的.

3203. 证明: 函数

$$f(x, y) = \begin{cases} \frac{x^2 y}{x^4 + y^2}, & \text{若 } x^2 + y^2 \neq 0, \\ 0, & \text{若 } x^2 + y^2 = 0, \end{cases}$$

在点 $O(0, 0)$ 沿着过此点的每一射线

$$x = t \cos \alpha, \quad y = t \sin \alpha \quad (0 \leq t < +\infty)$$

连续, 即

$$\lim_{t \rightarrow 0} f(t \cos \alpha, t \sin \alpha) = f(0, 0);$$

但此函数在点 $(0, 0)$ 并非连续的.

证 当 $\sin \alpha = 0$ 时, $\cos \alpha = 1$ 或 -1 . 于是, 当 $t \neq 0$

时, $f(t \cos \alpha, t \sin \alpha) = \frac{t^2 \cdot 0}{t^4 + 0} = 0$, 而 $f(0, 0) = 0$,

故有 $\lim_{t \rightarrow 0} f(t \cos \alpha, t \sin \alpha) = f(0, 0)$.

当 $\sin \alpha \neq 0$ 时, 有

$$\begin{aligned} \lim_{t \rightarrow 0} f(t \cos \alpha, t \sin \alpha) &= \lim_{t \rightarrow 0} \frac{t^3 \cos^2 \alpha \sin \alpha}{t^4 \cos^4 \alpha + t^2 \sin^2 \alpha} \\ &= \lim_{t \rightarrow 0} \frac{t \cos^2 \alpha \sin \alpha}{t^2 \cos^4 \alpha + \sin^2 \alpha} = \frac{0}{0 + \sin^2 \alpha} = 0, \end{aligned}$$

故 $\lim_{t \rightarrow 0} f(t \cos \alpha, t \sin \alpha) = f(0, 0)$.

其次, 设动点 $P(x, y)$ 沿抛物线 $y = x^2$ 趋于原点, 得

$$\lim_{\substack{x \rightarrow 0 \\ (y=x^2)}} f(x, y) = \lim_{x \rightarrow 0} \frac{x^4}{x^4 + x^4} = \frac{1}{2} \neq f(0, 0).$$

因此, 函数 $f(x, y)$ 在点 $(0, 0)$ 不连续.

3204. 证明: 函数

$$f(x, y) = x \sin \frac{1}{y}, \text{ 若 } y \neq 0 \text{ 及 } f(x, 0) = 0$$

的不连续点的集合不是封闭的.

证 当 $y_0 \neq 0$ 时, 函数 $f(x, y)$ 在点 (x_0, y_0) 显见是连续的, 即 $f(x, y)$ 在除去 Ox 轴以外的一切点均连续.

又因 $|f(x, y) - f(0, 0)| = |f(x, y)| \leq |x|$, 故知 $f(x, y)$ 在原点也是连续的.

考虑当 $x_0 \neq 0$ 时, 对于点 $(x_0, 0)$, 由于极限

$$\lim_{y \rightarrow 0} f(x_0, y) = \lim_{y \rightarrow 0} x_0 \sin \frac{1}{y}$$

不存在, 故知 $f(x, y)$ 在点 $(x_0, 0)$ 不连续.

这样, 我们证明了, 函数 $f(x, y)$ 的全部不连续点为 Ox 轴上除去原点外的一切点. 显然, 原点是不连续点集合的一个聚点, 但它本身却不是 $f(x, y)$ 的不连续点. 因此, $f(x, y)$ 的不连续点的集合不是封闭的.

3205. 证明: 若函数 $f(x, y)$ 在某域 G 内对变数 x 是连续的, 而关于 x 对变数 y 是一致连续的, 则此函数在所考虑的域内是连续的.

证 任意固定一点 $P_0(x_0, y_0) \in G$.

由于 $f(x, y)$ 关于 x 对变数 y 一致连续, 故对任给的 $\varepsilon > 0$, 存在 $\delta_1 = \delta_1(\varepsilon) > 0$, 使当 $(x, y') \in G$, $(x, y'') \in G$ 且 $|y' - y''| < \delta_1$ 时, 就有

$$|f(x, y') - f(x, y'')| < \frac{\varepsilon}{2}.$$

又因 $f(x, y)$ 在点 (x_0, y_0) 关于变数 x 是连续的, 故对上述的 ε , 存在 $\delta_2 > 0$, 使当 $|x - x_0| < \delta_2$ 时, 就有

$$|f(x, y_0) - f(x_0, y_0)| < \frac{\varepsilon}{2}.$$

取 $0 < \delta \leq \min\{\delta_1, \delta_2\}$, 并使点 (x_0, y_0) 的 δ 邻域全部包含在区域 G 内, 则当点 $P(x, y)$ 属于点 (x_0, y_0) 的 δ 邻域, 即 $|PP_0| < \delta$ 时,

$$|x - x_0| < \delta \leq \delta_2, \quad |y - y_0| < \delta \leq \delta_1.$$

从而有

$$\begin{aligned} |f(x, y) - f(x_0, y_0)| &\leq |f(x, y) - f(x, y_0)| \\ &\quad + |f(x, y_0) - f(x_0, y_0)| \\ &< \frac{\varepsilon}{2} + \frac{\varepsilon}{2} = \varepsilon. \end{aligned}$$

因此, $f(x, y)$ 在点 P_0 连续. 由 P_0 的任意性知, 函数 $f(x, y)$ 在 G 内是连续的.

3206. 证明: 若在某域 G 内函数 $f(x, y)$ 对变数 x 是连续的, 并满足对变数 y 的里普什兹条件, 即

$$|f(x, y') - f(x, y'')| \leq L|y' - y''|,$$

式中 $(x, y') \in G, (x, y'') \in G$ 而 L 为常数, 则此函数在已知域内是连续的.

证 由于 $f(x, y)$ 在 G 内满足对 y 的里普什兹条件, 故知 $f(x, y)$ 在 G 内关于 x 对变数 y 是一致连续的. 因此, 由 3205 题的结果, 即知 $f(x, y)$ 在 G 内是连续的.

3207. 证明: 若函数 $f(x, y)$ 分别地对每一个变数 x 和 y 是

连续的并对于其中的一个是单调的, 则此函数对两个变量的总体是连续的 (尤格定理)

证 不妨设 $f(x, y)$ 关于 x 是单调的.

设 (x_0, y_0) 为函数 $f(x, y)$ 的定义域 G 内的任一点. 由于 $f(x, y)$ 关于 x 连续, 故对任给的 $\varepsilon > 0$, 存在 $\delta_1 > 0$ (假定 δ_1 足够小, 使我们所考虑的点都落在 G 内), 使当 $|x - x_0| \leq \delta_1$ 时, 就有

$$|f(x, y_0) - f(x_0, y_0)| < \frac{\varepsilon}{2}.$$

对于点 $(x_0 - \delta_1, y_0)$ 及 $(x_0 + \delta_1, y_0)$, 由于 $f(x, y)$ 关于 y 连续, 故对上述的 ε , 存在 $\delta_2 > 0$ (也要求 δ_2 足够小, 使所考虑的点落在 G 内), 使当 $|y - y_0| \leq \delta_2$ 时, 就有

$$|f(x_0 - \delta_1, y) - f(x_0 - \delta_1, y_0)| < \frac{\varepsilon}{2}$$

及

$$|f(x_0 + \delta_1, y) - f(x_0 + \delta_1, y_0)| < \frac{\varepsilon}{2}.$$

令 $\delta = \min\{\delta_1, \delta_2\}$, 则当 $|\Delta x| < \delta, |\Delta y| < \delta$ 时, 由于 $f(x, y)$ 关于 x 单调, 故有

$$\begin{aligned} & |f(x_0 + \Delta x, y_0 + \Delta y) - f(x_0, y_0)| \\ & \leq \max\{|f(x_0 + \delta_1, y_0 + \Delta y) - f(x_0, y_0)|, \\ & |f(x_0 - \delta_1, y_0 + \Delta y) - f(x_0, y_0)|\}. \end{aligned}$$

但是

$$\begin{aligned} & |f(x_0 \pm \delta_1, y_0 + \Delta y) - f(x_0, y_0)| \\ & \leq |f(x_0 \pm \delta_1, y_0 + \Delta y) - f(x_0 \pm \delta_1, y_0)| \\ & \quad + |f(x_0 \pm \delta_1, y_0) - f(x_0, y_0)| \end{aligned}$$

$$< \frac{\varepsilon}{2} + \frac{\varepsilon}{2} = \varepsilon,$$

故当 $|\Delta x| < \delta, |\Delta y| < \delta$ 时, 就有

$$|f(x_0 + \Delta x, y_0 + \Delta y) - f(x_0, y_0)| < \varepsilon,$$

即 $f(x, y)$ 在点 (x_0, y_0) 是连续的. 由点 (x_0, y_0) 的任意性知, $f(x, y)$ 是 G 内的二元连续函数.

3208. 设函数 $f(x, y)$ 于域 $a \leq x \leq A, b \leq y \leq B$ 上是连续的, 而函数叙列 $\varphi_n(x)$ ($n = 1, 2, \dots$) 在 $[a, A]$ 上一致收敛并满足条件 $b \leq \varphi_n(x) \leq B$. 证明: 函数叙列

$$F_n(x) = f[x, \varphi_n(x)] \quad (n = 1, 2, \dots)$$

也在 $[a, A]$ 上一致收敛.

证 由于 $b \leq \varphi_n(x) \leq B$, 故 $F_n(x) = f[x, \varphi_n(x)]$ 有意义.

由题设 $f(x, y)$ 在域 $a \leq x \leq A, b \leq y \leq B$ 上连续, 故在此域上一致连续, 即对任给的 $\varepsilon > 0$, 存在 $\delta = \delta(\varepsilon) > 0$, 使对于此域中的任意两点 $(x_1, y_1), (x_2, y_2)$, 只要 $|x_1 - x_2| < \delta, |y_1 - y_2| < \delta$ 时, 就有

$$|f(x_1, y_1) - f(x_2, y_2)| < \varepsilon.$$

特别地, 当 $|y_1 - y_2| < \delta$ 时, 对于一切的 $x \in (a, A)$, 均有

$$|f(x, y_1) - f(x, y_2)| < \varepsilon.$$

对于上述的 $\delta > 0$, 因为 $\varphi_n(x)$ 在 (a, A) 上一致收敛, 故存在自然数 N , 使当 $m > N, n > N$ 时, 对于一切的 $x \in (a, A)$, 均有

$$|\varphi_n(x) - \varphi_m(x)| < \delta.$$

于是, 对任给的 $\varepsilon > 0$, 存在自然数 N , 使当 $m >$

N , $n > N$ 时, 对于一切的 $x \in (a, A)$, 均有

$$\begin{aligned} |F_n(x) - F_m(x)| &= \\ &= |f(x, \varphi_n(x)) - f(x, \varphi_m(x))| < \varepsilon. \end{aligned}$$

因此, $F_n(x)$ 在 (a, A) 上一致收敛.

3209. 设: 1) 函数 $f(x, y)$ 于域 $R(a < x < A; b < y < B)$ 内是连续的; 2) 函数 $\varphi(x)$ 于区间 (a, A) 内连续并有属于区间 (b, B) 内的值. 证明: 函数

$$F(x) = f(x, \varphi(x))$$

于区间 (a, A) 内是连续的.

证 设点 (x_0, y_0) 为域 R 中的任一点. 由题设知函数 $f(x, y)$ 于域 R 中连续, 故对任给的 $\varepsilon > 0$, 存在 $\delta > 0$, 使当 $|x - x_0| < \delta$, $|y - y_0| < \delta$ ($(x, y) \in R$) 时, 就有

$$|f(x, y) - f(x_0, y_0)| < \varepsilon.$$

再由 $\varphi(x)$ 在 (a, A) 中的连续性可知, 对上述的 $\delta > 0$, 存在 $\eta > 0$ (可取 $\eta < \delta$), 使当 $|x - x_0| < \eta$ ($x \in (a, A)$) 时, 恒有

$$|\varphi(x) - \varphi(x_0)| = |y - y_0| < \delta.$$

于是,

$$|f(x, \varphi(x)) - f(x_0, \varphi(x_0))| < \varepsilon,$$

即

$$|F(x) - F(x_0)| < \varepsilon.$$

因此, $F(x)$ 在点 x_0 处连续. 由 x_0 的任意性知函数 $F(x)$ 在 (a, A) 内是连续的.

3210. 设: 1) 函数 $f(x, y)$ 于域 $R(a < x < A; b < y < B)$ 内是连续的; 2) 函数 $x = \varphi(u, v)$ 及 $y = \psi(u, v)$ 于域 R'

$(a' < u < A'; b' < v < B')$ 内是连续的并有分别属于区间 (a, A) 和 (b, B) 的值. 证明: 函数

$$F(u, v) = f(\varphi(u, v), \psi(u, v))$$

于域 R' 内连续.

证 以下假定所取的 δ 或 η 足够小, 使点的 δ 或 η 邻域都在所给的域内.

设点 (x_0, y_0) 为域 R 中的任一点. 由于 $f(x, y)$ 在 R 内连续, 故对任给的 $\varepsilon > 0$, 存在 $\delta > 0$, 使当 $|x - x_0| < \delta, |y - y_0| < \delta$ 时, 就有

$$|f(x, y) - f(x_0, y_0)| < \varepsilon.$$

再由 φ 及 ψ 的连续性知, 对于上述的 δ , 存在 $\eta > 0$, 使当 $|u - u_0| < \eta, |v - v_0| < \eta$ 时, 就有

$$|x - x_0| < \delta, |y - y_0| < \delta,$$

其中 $x_0 = \varphi(u_0, v_0), y_0 = \psi(u_0, v_0)$.

于是, 对任给的 $\varepsilon > 0$, 存在 $\eta > 0$, 使当 $|u - u_0| < \eta, |v - v_0| < \eta$ 时, 就有

$$|f(\varphi(u, v), \psi(u, v)) - f(\varphi(u_0, v_0), \psi(u_0, v_0))| < \varepsilon,$$

即

$$|F(u, v) - F(u_0, v_0)| < \varepsilon.$$

因此, $F(u, v)$ 在点 (u_0, v_0) 连续, 由 (u_0, v_0) 的任意性知, 函数 $F(u, v)$ 于域 R' 内连续.

§2. 偏导函数. 多变量函数的微分

1° 偏导函数 若所论及的多变数的函数的一切偏导函

数是连续的, 则微分的结果与微分的次序无关.

2° 多变量函数的微分 若自变数 x, y, z 的函数 $f(x, y, z)$ 的全增量可写为下形

$$\Delta f(x, y, z) = A\Delta x + B\Delta y + C\Delta z + o(\rho),$$

式中 A, B, C 与 $\Delta x, \Delta y, \Delta z$ 无关而 $\rho = \sqrt{(\Delta x)^2 + (\Delta y)^2 + (\Delta z)^2}$, 则称函数 $f(x, y, z)$ 可微分, 而增量的线性主部 $A\Delta x + B\Delta y + C\Delta z$ 等于

$$df(x, y, z) = f'_x(x, y, z)dx + f'_y(x, y, z)dy + f'_z(x, y, z)dz, \quad (1)$$

(其中 $dx = \Delta x, dy = \Delta y, dz = \Delta z$) 称为此函数的微分.

当变数 x, y, z 为其他自变数的可微分的函数时, 公式(1)仍有其意义.

若 x, y, z 为自变数, 则对于高阶的微分, 有符号公式

$$d^2f(x, y, z) = \left(dx \frac{\partial}{\partial x} + dy \frac{\partial}{\partial y} + dz \frac{\partial}{\partial z} \right)^2 f(x, y, z).$$

3° 复合函数的导函数 若 $w = f(x, y, z)$, 其中 $x = \varphi(u, v), y = \psi(u, v), z = \chi(u, v)$ 且函数 φ, ψ, χ 可微分, 则

$$\frac{\partial w}{\partial u} = \frac{\partial w}{\partial x} \frac{\partial x}{\partial u} + \frac{\partial w}{\partial y} \frac{\partial y}{\partial u} + \frac{\partial w}{\partial z} \frac{\partial z}{\partial u},$$

$$\frac{\partial w}{\partial v} = \frac{\partial w}{\partial x} \frac{\partial x}{\partial v} + \frac{\partial w}{\partial y} \frac{\partial y}{\partial v} + \frac{\partial w}{\partial z} \frac{\partial z}{\partial v}.$$

计算函数 w 的二阶导函数时最好用下列符号公式:

$$\frac{\partial^2 w}{\partial u^2} = \left(P_1 \frac{\partial}{\partial x} + Q_1 \frac{\partial}{\partial y} + R_1 \frac{\partial}{\partial z} \right)^2 w + \frac{\partial P_1}{\partial u} \frac{\partial w}{\partial x}$$

$$+ \frac{\partial Q_1}{\partial u} \frac{\partial w}{\partial y} + \frac{\partial R_1}{\partial u} \frac{\partial w}{\partial z}$$

$$\text{及 } \frac{\partial^2 w}{\partial u \partial v} = \left(P_1 \frac{\partial}{\partial x} + Q_1 \frac{\partial}{\partial y} + R_1 \frac{\partial}{\partial z} \right) \left(P_2 \frac{\partial}{\partial x} + Q_2 \frac{\partial}{\partial y} + R_2 \frac{\partial}{\partial z} \right) w + \frac{\partial P_1}{\partial v} \frac{\partial w}{\partial x} + \frac{\partial Q_1}{\partial v} \frac{\partial w}{\partial y} + \frac{\partial R_1}{\partial v} \frac{\partial w}{\partial z},$$

$$\text{其中 } P_1 = \frac{\partial x}{\partial u}, Q_1 = \frac{\partial y}{\partial u}, R_1 = \frac{\partial z}{\partial u}$$

$$\text{及 } R_2 = \frac{\partial x}{\partial v}, Q_2 = \frac{\partial y}{\partial v}, R_2 = \frac{\partial z}{\partial v}.$$

4° 在已知方向上的导函数 若用方向余弦 $\{\cos \alpha, \cos \beta, \cos \gamma\}$ 表 $Oxyz$ 空间内的方向 l , 且函数 $u = f(x, y, z)$ 可微分, 则沿方向 l 的导函数按下式来计算

$$\frac{\partial u}{\partial l} = \frac{\partial u}{\partial x} \cos \alpha + \frac{\partial u}{\partial y} \cos \beta + \frac{\partial u}{\partial z} \cos \gamma.$$

在已知点函数增加最迅速的速度之大小与方向用 向量——函数的梯度

$$\text{grad } u = \frac{\partial u}{\partial x} \vec{i} + \frac{\partial u}{\partial y} \vec{j} + \frac{\partial u}{\partial z} \vec{k}$$

来表示, 它的大小等于

$$|\text{grad } u| = \sqrt{\left(\frac{\partial u}{\partial x}\right)^2 + \left(\frac{\partial u}{\partial y}\right)^2 + \left(\frac{\partial u}{\partial z}\right)^2}.$$

3211. 证明:

$$f'_x(x, b) = \frac{d}{dx}[f(x, b)].$$

证 令 $\varphi(x) = f(x, b)$, 则

$$\begin{aligned} \frac{d}{dx}[f(x, b)] &= \varphi'(x) = \lim_{\Delta x \rightarrow 0} \frac{\varphi(x + \Delta x) - \varphi(x)}{\Delta x} \\ &= \lim_{\Delta x \rightarrow 0} \frac{f(x + \Delta x, b) - f(x, b)}{\Delta x} = f'_x(x, b). \end{aligned}$$

注 在求某一固定点的导数及微分时, 用本题的结果常可减少运算量. 在本节中, 我们就多次利用本题的结果来简化运算.

3212. 设:

$$f(x, y) = x + (y-1) \arcsin \sqrt{\frac{x}{y}},$$

求 $f'_x(x, 1)$.

解 由于 $f(x, 1) = x$, 故 $f'_x(x, 1) = 1$.

求下列函数的一阶和二阶偏导函数:

3213. $u = x^4 + y^4 - 4x^2y^2$.

$$\text{解 } \frac{\partial u}{\partial x} = 4x^3 - 8xy^2, \quad \frac{\partial u}{\partial y} = 4y^3 - 8x^2y,$$

$$\frac{\partial^2 u}{\partial x^2} = 12x^2 - 8y^2, \quad \frac{\partial^2 u}{\partial y^2} = 12y^2 - 8x^2,$$

$$\frac{\partial^2 u}{\partial x \partial y} = \frac{\partial^2 u}{\partial y \partial x} = -16xy^{*}).$$

*) 以下各题不再写 $\frac{\partial^2 u}{\partial y \partial x} = \frac{\partial^2 u}{\partial x \partial y}$, 而仅写 $\frac{\partial^2 u}{\partial x \partial y}$, 因为当它们连续时是相等的, 并且在今后各题中均把

$\frac{\partial^2 u}{\partial x \partial y}$ 理解为 $\frac{\partial}{\partial y} \left(\frac{\partial u}{\partial x} \right)$.

3214. $u = xy + \frac{x}{y}$.

解 $\frac{\partial u}{\partial x} = y + \frac{1}{y}$, $\frac{\partial u}{\partial y} = x - \frac{x}{y^2}$,

$$\frac{\partial^2 u}{\partial x^2} = 0, \quad \frac{\partial^2 u}{\partial y^2} = \frac{2x}{y^3}, \quad \frac{\partial^2 u}{\partial x \partial y} = 1 - \frac{1}{y^2}.$$

3215. $u = \frac{x}{y^2}$.

解 $\frac{\partial u}{\partial x} = \frac{1}{y^2}$, $\frac{\partial u}{\partial y} = -\frac{2x}{y^3}$,

$$\frac{\partial^2 u}{\partial x^2} = 0, \quad \frac{\partial^2 u}{\partial y^2} = \frac{6x}{y^4}, \quad \frac{\partial^2 u}{\partial x \partial y} = -\frac{2}{y^3}.$$

3216. $u = \frac{x}{\sqrt{x^2 + y^2}}$.

解 $\frac{\partial u}{\partial x} = \frac{1}{\sqrt{x^2 + y^2}} - \frac{2x \cdot x}{2(x^2 + y^2)^{\frac{3}{2}}} = \frac{y^2}{(x^2 + y^2)^{\frac{3}{2}}}$,

$$\frac{\partial u}{\partial y} = -\frac{xy}{(x^2 + y^2)^{\frac{3}{2}}}$$

$$\frac{\partial^2 u}{\partial x^2} = -\frac{3}{2} y^2 \cdot \frac{2x}{(x^2 + y^2)^{\frac{5}{2}}} = -\frac{3xy^2}{(x^2 + y^2)^{\frac{5}{2}}}$$

$$\frac{\partial^2 u}{\partial y^2} = -\frac{x}{(x^2 + y^2)^{\frac{3}{2}}} + \frac{3}{2} xy \cdot \frac{2y}{(x^2 + y^2)^{\frac{5}{2}}}$$

$$= \frac{x(2y^2 - x^2)}{(x^2 + y^2)^{\frac{5}{2}}},$$

$$\frac{\partial^2 u}{\partial x \partial y} = \frac{\partial}{\partial y} \left[\frac{y^2}{(x^2 + y^2)^{\frac{3}{2}}} \right]$$

$$= \frac{2y}{(x^2 + y^2)^{\frac{3}{2}}} - \frac{3y^3}{(x^2 + y^2)^{\frac{5}{2}}} = \frac{y(2x^2 - y^2)}{(x^2 + y^2)^{\frac{5}{2}}}.$$

3217. $u = x \sin(x + y).$

解 $\frac{\partial u}{\partial x} = \sin(x + y) + x \cos(x + y),$

$$\frac{\partial u}{\partial y} = x \cos(x + y),$$

$$\begin{aligned} \frac{\partial^2 u}{\partial x^2} &= \cos(x + y) + \cos(x + y) - x \sin(x + y) \\ &= 2\cos(x + y) - x \sin(x + y), \end{aligned}$$

$$\frac{\partial^2 u}{\partial y^2} = -x \sin(x + y),$$

$$\frac{\partial^2 u}{\partial x \partial y} = \cos(x + y) - x \sin(x + y).$$

3218. $u = \frac{\cos x^2}{y}.$

解 $\frac{\partial u}{\partial x} = -\frac{2x \sin x^2}{y}, \quad \frac{\partial u}{\partial y} = -\frac{\cos x^2}{y^2},$

$$\frac{\partial^2 u}{\partial x^2} = -\frac{2 \sin x^2 + 4x^2 \cos x^2}{y},$$

$$\frac{\partial^2 u}{\partial y^2} = \frac{2 \cos x^2}{y^3}$$

$$\frac{\partial^2 u}{\partial x \partial y} = \frac{2x \sin x^2}{y^2}$$

3219. $u = \operatorname{tg} \frac{x^2}{y}$.

解 $\frac{\partial u}{\partial x} = \frac{2x}{y} \sec^2 \frac{x^2}{y}, \quad \frac{\partial u}{\partial y} = -\frac{x^2}{y^2} \sec^2 \frac{x^2}{y},$

$$\frac{\partial^2 u}{\partial x^2} = \frac{2}{y} \sec^2 \frac{x^2}{y} + \frac{2x}{y} \cdot 2 \sec^2 \frac{x^2}{y} \cdot \operatorname{tg} \frac{x^2}{y} \cdot \frac{2x}{y}$$

$$= \frac{2}{y} \sec^2 \frac{x^2}{y} + \frac{8x^2}{y^2} \sec^2 \frac{x^2}{y} \sin \frac{x^2}{y},$$

$$\frac{\partial^2 u}{\partial y^2} = \frac{2x^2}{y^3} \sec^2 \frac{x^2}{y} + \frac{2x^4}{y^4} \sec^2 \frac{x^2}{y} \sin \frac{x^2}{y},$$

$$\frac{\partial^2 u}{\partial x \partial y} = -\frac{2x}{y^2} \sec^2 \frac{x^2}{y} - \frac{4x^3}{y^3} \sec^2 \frac{x^2}{y} \sin \frac{x^2}{y}$$

3220. $u = x^y$.

解 由 $u = x^y = e^{y \ln x}$ 即得

$$\frac{\partial u}{\partial x} = yx^{y-1}, \quad \frac{\partial u}{\partial y} = e^{y \ln x} \cdot \ln x = x^y \ln x,$$

$$\frac{\partial^2 u}{\partial x^2} = y(y-1)x^{y-2}, \quad \frac{\partial^2 u}{\partial y^2} = x^y \ln^2 x,$$

$$\frac{\partial^2 u}{\partial x \partial y} = x^{y-1} + yx^{y-1} \ln x$$

$$= x^{y-1}(1+y \ln x) \quad (x > 0).$$

3221. $u = \ln(x + y^2).$

解 $\frac{\partial u}{\partial x} = \frac{1}{x + y^2}, \quad \frac{\partial u}{\partial y} = \frac{2y}{x + y^2},$

$$\frac{\partial^2 u}{\partial x^2} = -\frac{1}{(x + y^2)^2},$$

$$\frac{\partial^2 u}{\partial y^2} = \frac{2}{x + y^2} - \frac{2y \cdot 2y}{(x + y^2)^2} = \frac{2(x - y^2)}{(x + y^2)^2},$$

$$\frac{\partial^2 u}{\partial x \partial y} = -\frac{2y}{(x + y^2)^2}.$$

3222. $u = \operatorname{arc} \operatorname{tg} \frac{y}{x}.$

解 $\frac{\partial u}{\partial x} = \frac{1}{1 + \left(\frac{y}{x}\right)^2} \left(-\frac{y}{x^2}\right) = -\frac{y}{x^2 + y^2},$

$$\frac{\partial u}{\partial y} = \frac{1}{1 + \left(\frac{y}{x}\right)^2} \cdot \frac{1}{x} = \frac{x}{x^2 + y^2},$$

$$\frac{\partial^2 u}{\partial x^2} = \frac{2xy}{(x^2 + y^2)^2}, \quad \frac{\partial^2 u}{\partial y^2} = -\frac{2xy}{(x^2 + y^2)^2},$$

$$\frac{\partial^2 u}{\partial x \partial y} = -\frac{1}{x^2 + y^2} + \frac{y \cdot 2y}{(x^2 + y^2)^2}$$

$$= -\frac{x^2 - y^2}{(x^2 + y^2)^2}.$$

3223. $u = \operatorname{arc} \operatorname{tg} \frac{x + y}{1 - xy}.$

解 由776题知

$$\operatorname{arc\,tg} \frac{x+y}{1-xy} = \operatorname{arc\,tg} x + \operatorname{arc\,tg} y - \varepsilon\pi,$$

其中 $\varepsilon = 0, 1$ 或 -1 . 于是,

$$\frac{\partial u}{\partial x} = \frac{1}{1+x^2}, \quad \frac{\partial u}{\partial y} = \frac{1}{1+y^2},$$

$$\frac{\partial^2 u}{\partial x^2} = -\frac{2x}{(1+x^2)^2}, \quad \frac{\partial^2 u}{\partial y^2} = -\frac{2y}{(1+y^2)^2},$$

$$\frac{\partial^2 u}{\partial x \partial y} = 0.$$

本题如不用776题的结果, 直接求导数也可获解.

例如,

$$\begin{aligned} \frac{\partial u}{\partial x} &= \frac{1}{1 + \left(\frac{x+y}{1-xy}\right)^2} \cdot \frac{1-xy + y(x+y)}{(1-xy)^2} \\ &= \frac{1}{1+x^2}. \end{aligned}$$

3224. $u = \operatorname{arc\,sin} \frac{x}{\sqrt{x^2+y^2}}.$

$$\begin{aligned} \text{解} \quad \frac{\partial u}{\partial x} &= \frac{1}{\sqrt{1 - \frac{x^2}{x^2+y^2}}} \left(\frac{x}{\sqrt{x^2+y^2}} \right)' \\ &= \frac{\sqrt{x^2+y^2}}{|y|} \cdot \frac{y^2}{(x^2+y^2)^{\frac{3}{2}}} \quad *) \end{aligned}$$

$$= \frac{|y|}{x^2 + y^2}.$$

$$\frac{\partial u}{\partial y} = \frac{1}{\sqrt{1 - \frac{x^2}{x^2 + y^2}}} \left(\frac{x}{\sqrt{x^2 + y^2}} \right)'$$

$$= \frac{\sqrt{x^2 + y^2}}{|y|} \left[-\frac{xy}{(x^2 + y^2)^{\frac{3}{2}}} \right]^*)$$

$$= -\frac{x}{x^2 + y^2} \cdot \frac{y}{|y|} = -\frac{x \operatorname{sgn} y}{x^2 + y^2},$$

$$\frac{\partial^2 u}{\partial x^2} = -\frac{2x|y|}{(x^2 + y^2)^2},$$

$$\frac{\partial^2 u}{\partial y^2} = \frac{\partial}{\partial y} \left[-\frac{xy}{|y|(x^2 + y^2)} \right]$$

$$= -\frac{x|y|(x^2 + y^2) - xy \left[\frac{|y|}{y}(x^2 + y^2) + 2y|y| \right]}{y^2(x^2 + y^2)^2}$$

$$= \frac{2x|y|}{(x^2 + y^2)^2},$$

$$\frac{\partial^2 u}{\partial x \partial y} = \frac{\frac{|y|}{y}(x^2 + y^2) - 2y|y|}{(x^2 + y^2)^2}$$

$$= \frac{x^2 \operatorname{sgn} y - y|y|}{(x^2 + y^2)^2} = \frac{(x^2 - y^2) \operatorname{sgn} y}{(x^2 + y^2)^2} \quad (y \neq 0).$$

*) 利用3216题的结果.

$$3225. \quad u = \frac{1}{\sqrt{x^2 + y^2 + z^2}}.$$

$$\text{解 } \frac{\partial u}{\partial x} = -\frac{x}{(x^2 + y^2 + z^2)^{\frac{5}{2}}},$$

$$\frac{\partial u}{\partial y} = -\frac{y}{(x^2 + y^2 + z^2)^{\frac{5}{2}}},$$

$$\frac{\partial u}{\partial z} = -\frac{z}{(x^2 + y^2 + z^2)^{\frac{5}{2}}},$$

$$\begin{aligned} \frac{\partial^2 u}{\partial x^2} &= -\frac{1}{(x^2 + y^2 + z^2)^{\frac{5}{2}}} + \frac{3x^2}{(x^2 + y^2 + z^2)^{\frac{7}{2}}} \\ &= \frac{2x^2 - y^2 - z^2}{(x^2 + y^2 + z^2)^{\frac{7}{2}}}, \end{aligned}$$

$$\frac{\partial^2 u}{\partial x \partial y} = \frac{3xy}{(x^2 + y^2 + z^2)^{\frac{7}{2}}}.$$

利用对称性，即得

$$\frac{\partial^2 u}{\partial y^2} = \frac{2y^2 - x^2 - z^2}{(x^2 + y^2 + z^2)^{\frac{7}{2}}}, \quad \frac{\partial^2 u}{\partial z^2} = \frac{2z^2 - x^2 - y^2}{(x^2 + y^2 + z^2)^{\frac{7}{2}}},$$

$$\frac{\partial^2 u}{\partial y \partial z} = \frac{3yz}{(x^2 + y^2 + z^2)^{\frac{7}{2}}},$$

$$\frac{\partial^2 u}{\partial z \partial x} = \frac{3xz}{(x^2 + y^2 + z^2)^{\frac{7}{2}}}.$$

3226. $u = \left(\frac{x}{y}\right)^x.$

解 $u = x^x y^{-x}.$

$$\frac{\partial u}{\partial x} = z x^{z-1} y^{-z} = \frac{z}{x} \left(\frac{x}{y}\right)^z,$$

$$\frac{\partial u}{\partial y} = -z x^z y^{-z-1} = -\frac{z}{y} \left(\frac{x}{y}\right)^z,$$

$$\frac{\partial u}{\partial z} = \left(\frac{x}{y}\right)^z \ln \frac{x}{y},$$

$$\frac{\partial^2 u}{\partial x^2} = z(z-1) x^{z-2} y^{-z} = \frac{z(z-1)}{x^2} \left(\frac{x}{y}\right)^z,$$

$$\frac{\partial^2 u}{\partial y^2} = (-z)(-z-1) x^z y^{-z-2} = \frac{z(z+1)}{y^2} \left(\frac{x}{y}\right)^z,$$

$$\frac{\partial^2 u}{\partial z^2} = \left(\frac{x}{y}\right)^z \ln^2 \frac{x}{y},$$

$$\frac{\partial^2 u}{\partial x \partial y} = \left(\frac{z}{x} u\right)'_y = \frac{z}{x} \left[-\frac{z}{y} \left(\frac{x}{y}\right)^z\right]$$

$$= -\frac{z^2}{xy} \left(\frac{x}{y}\right)^z,$$

$$\frac{\partial^2 u}{\partial y \partial z} = \left(-\frac{z}{y} u\right)'_z = -\frac{z}{y} \left(\frac{x}{y}\right)^z \ln \frac{x}{y} - \frac{1}{y} \left(\frac{x}{y}\right)^z$$

$$= -\frac{1+z \ln \frac{x}{y}}{y} \left(\frac{x}{y}\right)^z,$$

$$\frac{\partial^2 u}{\partial z \partial x} = \left(u \ln \frac{x}{y}\right)'_x = \frac{z}{x} \left(\frac{x}{y}\right)^z \ln \frac{x}{y} + \frac{1}{x} \left(\frac{x}{y}\right)^z$$

$$= \frac{1+z \ln \frac{x}{y}}{x} \left(\frac{x}{y}\right)^z \quad \left(\frac{x}{y} > 0\right).$$

3227. $u = x^{\frac{y}{z}}$.

解 $\frac{\partial u}{\partial x} = \frac{y}{z} x^{\frac{y}{z}-1} = \frac{yu}{xz}$,

$$\frac{\partial u}{\partial y} = \frac{1}{z} x^{\frac{y}{z}} \ln x = \frac{u \ln x}{z},$$

$$\frac{\partial u}{\partial z} = -\frac{y}{z^2} x^{\frac{y}{z}} \ln x = -\frac{yu \ln x}{z^2},$$

$$\frac{\partial^2 u}{\partial x^2} = \frac{xyz \frac{\partial u}{\partial x} - yzu}{x^2 z^2} = \frac{y(y-z)u}{x^2 z^2},$$

$$\frac{\partial^2 u}{\partial y^2} = \frac{\ln x}{z} \frac{\partial u}{\partial y} = \frac{u \ln^2 x}{z^2},$$

$$\begin{aligned} \frac{\partial^2 u}{\partial z^2} &= -y \ln x \cdot \left[\frac{z^2 \frac{\partial u}{\partial z} - 2uz}{z^4} \right] \\ &= \frac{yu \ln x \cdot (2z + y \ln x)}{z^4}, \end{aligned}$$

$$\frac{\partial^2 u}{\partial x \partial y} = \frac{1}{xz} \left(u + y \frac{\partial u}{\partial y} \right) = \frac{u(z + y \ln x)}{xz^2},$$

$$\begin{aligned} \frac{\partial^2 u}{\partial y \partial z} &= \ln x \cdot \left(\frac{1}{z} \frac{\partial u}{\partial z} - \frac{u}{z^2} \right) \\ &= -\frac{u \ln x \cdot (z + y \ln x)}{z^3}, \end{aligned}$$

$$\frac{\partial^2 u}{\partial z \partial x} = -\frac{y}{z^2} \left(\ln x \frac{\partial u}{\partial x} + \frac{u}{x} \right) = -\frac{yu(z + y \ln x)}{xy^3}.$$

$$3228. \quad u = x^{y^z}$$

$$\text{解} \quad \frac{\partial u}{\partial x} = y^z x^{y^z-1} = \frac{u y^z}{x}$$

$$\frac{\partial u}{\partial y} = z y^{z-1} x^{y^z} \ln x = z u y^{z-1} \ln x,$$

$$\frac{\partial u}{\partial z} = x^{y^z} y^z \ln x \cdot \ln y = u y^z \ln x \cdot \ln y,$$

$$\frac{\partial^2 u}{\partial x^2} = y^z \left(-\frac{u}{x^2} + \frac{1}{x} \frac{\partial u}{\partial x} \right) = \frac{u y^z (y^z - 1)}{x^2},$$

$$\begin{aligned} \frac{\partial^2 u}{\partial y^2} &= z \ln x \cdot \left[y^{z-1} \frac{\partial u}{\partial y} + (z-1) y^{z-2} u \right] \\ &= u z y^{z-2} \ln x \cdot (z y^z \ln x + z - 1), \end{aligned}$$

$$\begin{aligned} \frac{\partial^2 u}{\partial z^2} &= \left(y^z \frac{\partial u}{\partial z} + u y^z \ln y \right) \ln x \cdot \ln y \\ &= u y^z \ln x \cdot \ln^2 y \cdot (1 + y^z \ln x), \end{aligned}$$

$$\begin{aligned} \frac{\partial^2 u}{\partial x \partial y} &= \frac{1}{x} \left(y^z \frac{\partial u}{\partial y} + u z y^{z-1} \right) \\ &= \frac{u z y^{z-1} (y^z \ln x + 1)}{x}, \end{aligned}$$

$$\begin{aligned} \frac{\partial^2 u}{\partial y \partial z} &= \left(y^{z-1} u + u z y^{z-1} \ln y + z y^{z-1} \frac{\partial u}{\partial z} \right) \ln x \\ &= u y^{z-1} \ln x \cdot (1 + z \ln y \cdot (1 + y^z \ln x)), \end{aligned}$$

$$\begin{aligned}\frac{\partial^2 u}{\partial z \partial x} &= y^x \ln y \cdot \left(\frac{\partial u}{\partial x} \ln x + \frac{u}{x} \right) \\ &= \frac{u y^x \ln y \cdot (y^x \ln x + 1)}{x} \quad (x > 0, y > 0).\end{aligned}$$

3229. 设 (a) $u = x^2 - 2xy - 3y^2$; (b) $u = x^{y^2}$; (B) $u =$

$\arccos \sqrt{\frac{x}{y}}$, 验证等式

$$\frac{\partial^2 u}{\partial x \partial y} = \frac{\partial^2 u}{\partial y \partial x}.$$

证 (a) $\frac{\partial u}{\partial x} = 2x - 2y, \frac{\partial u}{\partial y} = -2x - 6y,$

$$\frac{\partial^2 u}{\partial x \partial y} = -2, \frac{\partial^2 u}{\partial y \partial x} = -2,$$

于是, $\frac{\partial^2 u}{\partial x \partial y} = \frac{\partial^2 u}{\partial y \partial x}.$

(b) $\frac{\partial u}{\partial x} = y^2 x^{y^2-1}, \frac{\partial u}{\partial y} = 2yx^{y^2} \ln x \quad (x > 0),$

$$\frac{\partial^2 u}{\partial x \partial y} = 2yx^{y^2-1} + 2y^3 x^{y^2-1} \ln x,$$

$$\frac{\partial^2 u}{\partial y \partial x} = 2y^3 x^{y^2-1} \ln x + 2yx^{y^2-1},$$

于是, $\frac{\partial^2 u}{\partial x \partial y} = \frac{\partial^2 u}{\partial y \partial x}.$

(B) 当 $0 < x \leq y$ 时, 我们有

$$u = \arccos \sqrt{\frac{x}{y}} = \arccos \frac{\sqrt{x}}{\sqrt{y}}.$$

$$\frac{\partial u}{\partial x} = -\frac{1}{\sqrt{1-\frac{x}{y}}} \cdot \frac{1}{2\sqrt{x}\sqrt{y}} = -\frac{1}{2\sqrt{x}(y-x)},$$

$$\frac{\partial u}{\partial y} = -\frac{1}{\sqrt{1-\frac{x}{y}}} \left(-\frac{\sqrt{x}}{2y^{\frac{3}{2}}} \right) = \frac{\sqrt{x}}{2\sqrt{y^2}(y-x)},$$

$$\frac{\partial^2 u}{\partial x \partial y} = \frac{1}{4\sqrt{x}(y-x)^{\frac{3}{2}}},$$

$$\frac{\partial^2 u}{\partial y \partial x} = \frac{1}{4\sqrt{x}\sqrt{y^2}(y-x)} + \frac{\sqrt{x}}{4y(y-x)^{\frac{3}{2}}}$$

$$= \frac{1}{4\sqrt{x}(y-x)^{\frac{3}{2}}},$$

于是, 当 $0 < x \leq y$ 时, 有

$$\frac{\partial^2 u}{\partial x \partial y} = \frac{\partial^2 u}{\partial y \partial x}.$$

$$\text{当 } y \leq x < 0 \text{ 时, } u = \arccos \frac{\sqrt{-x}}{\sqrt{-y}}.$$

$$\frac{\partial u}{\partial x} = -\frac{1}{\sqrt{1-\frac{x}{y}}} \left(-\frac{1}{2\sqrt{-x}\sqrt{-y}} \right)$$

$$= \frac{1}{2\sqrt{-x}\sqrt{x-y}},$$

$$\frac{\partial u}{\partial y} = \frac{1}{\sqrt{1-\frac{x}{y}}} \left[\frac{\sqrt{-x}}{2(-y)^{\frac{3}{2}}} \right] = -\frac{\sqrt{-x}}{2\sqrt{xy^2-y^3}},$$

$$\frac{\partial^2 u}{\partial x \partial y} = \frac{1}{4\sqrt{-x}(x-y)^{\frac{3}{2}}},$$

$$\frac{\partial^2 u}{\partial y \partial x} = \frac{1}{4\sqrt{-x}\sqrt{xy^2-y^3}} + \frac{\sqrt{-x}}{4\sqrt{y^2}(x+y)^{\frac{3}{2}}}$$

$$= \frac{1}{4\sqrt{-x}(x-y)^{\frac{3}{2}}},$$

于是, 当 $y \leq x < 0$ 时, 也有

$$\frac{\partial^2 u}{\partial x \partial y} = \frac{\partial^2 u}{\partial y \partial x}.$$

仔细观察可以看到, 在不同的区域上, 一阶偏导数相差一个符号, 但二阶混合偏导数却是相等的.

3230. 设 $f(x, y) = xy \frac{x^2 - y^2}{x^2 + y^2}$, 若 $x^2 + y^2 \neq 0$ 及 $f(0, 0) =$

0. 证明

$$f''_{xy}(0, 0) \neq f''_{yx}(0, 0).$$

证 由于

$$\lim_{x \rightarrow 0} \frac{f(x, y) - f(0, y)}{x} = \lim_{x \rightarrow 0} \frac{xy \frac{x^2 - y^2}{x^2 + y^2} - 0}{x} = -y,$$

故 $f'_x(0, y) = -y$, 从而

$$f''_{yx}(0, 0) = \left. \frac{d}{dy} [f'_x(0, y)] \right|_{y=0} = -1$$

同法可求得 $f'_y(x, 0) = x$, 从而

$$f''_{yx}(0, 0) = \left. \frac{d}{dx} [f'_y(x, 0)] \right|_{x=0} = 1.$$

于是, $f''_{xy}(0, 0) \neq f''_{yx}(0, 0)$.

3231. 设 $u = f(x, y, z)$ 为 n 次齐次函数, 就下列各题验证关于齐次函数的尤拉定理:

(a) $u = (x - 2y + 3z)^2$; (b) $u = \frac{x}{\sqrt{x^2 + y^2 + z^2}}$;

(B) $u = \left(\frac{x}{y}\right)^{\frac{1}{2}}$.

证 关于 n 次齐次函数的尤拉定理如下:

设 n 次齐次函数 $f(x, y, z)$ * 在域 A 中关于所有变量均有连续偏导函数, 则下述等式成立

$$\begin{aligned} & x f'_x(x, y, z) + y f'_y(x, y, z) + z f'_z(x, y, z) \\ &= n f(x, y, z). \end{aligned}$$

(a) 由于 $(tx - 2ty + 3tz)^2 = t^2 u$, 故 u 为二次齐次函数. 又因

* 为了书写的简便, 在这里我们仅限于讨论三个变量的情形.

$$\frac{\partial u}{\partial x} = 2(x - 2y + 3z), \quad \frac{\partial u}{\partial y} = -4(x - 2y + 3z),$$

$$\frac{\partial u}{\partial z} = 6(x - 2y + 3z),$$

故得

$$x \frac{\partial u}{\partial x} + y \frac{\partial u}{\partial y} + z \frac{\partial u}{\partial z} = (x - 2y + 3z)(2x - 4y + 6z) = 2u,$$

即函数 u 满足尤拉定理.

(6) 由于对任何的 $t > 0$,

$$\frac{tx}{\sqrt{(tx)^2 + (ty)^2 + (tz)^2}} = \frac{x}{\sqrt{x^2 + y^2 + z^2}} = t^0 \cdot u,$$

故 u 为零次齐次函数. 又因

$$\frac{\partial u}{\partial x} = \frac{y^2 + z^2}{(x^2 + y^2 + z^2)^{\frac{3}{2}}}, \quad \frac{\partial u}{\partial y} = -\frac{xy}{(x^2 + y^2 + z^2)^{\frac{3}{2}}},$$

$$\frac{\partial u}{\partial z} = -\frac{xz}{(x^2 + y^2 + z^2)^{\frac{3}{2}}},$$

故得

$$x \frac{\partial u}{\partial x} + y \frac{\partial u}{\partial y} + z \frac{\partial u}{\partial z} = \frac{1}{(x^2 + y^2 + z^2)^{\frac{3}{2}}} (xy^2 + xz^2 - xy^2 - xz^2) = 0 \cdot u,$$

即函数 u 满足尤拉定理.

(B) 由于

$$\left(\frac{tx}{ty}\right)^{\frac{n}{t}} = \left(\frac{x}{y}\right)^{\frac{n}{t}} = t^0 \cdot u \quad (t > 0),$$

故函数 u 为零次齐次函数. 又因

$$\frac{\partial u}{\partial x} = \frac{1}{y} \cdot \frac{y}{z} \left(\frac{x}{y}\right)^{\frac{n}{t}-1} = \frac{yu}{xz},$$

$$\begin{aligned} \frac{\partial u}{\partial y} &= \left(e^{\frac{n}{t} \ln \frac{x}{y}}\right)' \cdot \left(\frac{x}{y}\right)^{\frac{n}{t}} \cdot \left[\frac{1}{z} \ln \frac{x}{y} - \frac{y}{z} \cdot \frac{1}{y}\right] \\ &= \frac{u}{z} \left(\ln \frac{x}{y} - 1\right), \end{aligned}$$

$$\frac{\partial u}{\partial z} = \left(\frac{x}{y}\right)^{\frac{n}{t}} \ln \frac{x}{y} \cdot \left(-\frac{y}{z^2}\right) = -\frac{yu}{z^2} \ln \frac{x}{y},$$

故得

$$\begin{aligned} x \frac{\partial u}{\partial x} + y \frac{\partial u}{\partial y} + z \frac{\partial u}{\partial z} &= x \cdot \frac{yu}{xz} + y \cdot \frac{u}{z} \left(\ln \frac{x}{y} - 1\right) \\ &\quad - z \cdot \frac{yu}{z^2} \ln \frac{x}{y} = 0 \cdot u, \end{aligned}$$

即函数 u 满足尤拉定理.

3232. 证明: 若可微函数 $u = f(x, y, z)$ 满足方程式

$$x \frac{\partial u}{\partial x} + y \frac{\partial u}{\partial y} + z \frac{\partial u}{\partial z} = nu,$$

则它为 n 次齐次函数.

证 任意固定域中一点 (x_0, y_0, z_0) , 考察下面的 t 的函数 ($t > 0$):

$$F(t) = \frac{f(tx_0, ty_0, tz_0)}{t^n},$$

它当 $t > 0$ 时有定义且是可微的。应用复合函数的求导法则，对 t 求导数即得

$$\begin{aligned} F'(t) &= \frac{1}{t^n} \left\{ x_0 f'_x (tx_0, ty_0, tz_0) + y_0 f'_y (tx_0, \right. \\ &\quad \left. ty_0, tz_0) + z_0 f'_z (tx_0, ty_0, tz_0) \right\} \\ &\quad - \frac{n}{t^{n+1}} f (tx_0, ty_0, tz_0) \\ &= \frac{1}{t^{n+1}} \left\{ tx_0 f'_x (tx_0, ty_0, tz_0) + ty_0 \right. \\ &\quad \cdot f'_y (tx_0, ty_0, tz_0) + tz_0 f'_z (tx_0, ty_0, tz_0) \\ &\quad \left. - nf (tx_0, ty_0, tz_0) \right\}, \end{aligned}$$

由于 $tx_0 f'_x (tx_0, ty_0, tz_0) + ty_0 f'_y (tx_0, ty_0, tz_0) + tz_0$

$$\cdot f'_z (tx_0, ty_0, tz_0) = nf (tx_0, ty_0, tz_0),$$

故

$$F'(t) = 0.$$

从而当 $t > 0$ 时， $F(t) = c$ ，其中 c 为常数。现在确定 c 。为此，在定义 $F(t)$ 的等式中令 $t = 1$ ，则得

$$c = f(x_0, y_0, z_0).$$

于是，

$$\bar{F}(t) = \frac{f(tx_0, ty_0, tz_0)}{t^n} = f(x_0, y_0, z_0),$$

即

$$f(tx_0, ty_0, tz_0) = t^n f(x_0, y_0, z_0).$$

上式说明函数 $f(x, y, z)$ 为一个 n 次的齐次函数，这就是所要证明的。

3233. 证明：若 $f(x, y, z)$ 是可微分的 n 次齐次函数，则其偏导函数 $f'_x(x, y, z), f'_y(x, y, z), f'_z(x, y, z)$ 是 $(n-1)$ 次的齐次函数。

证 由等式

$$f(tx, ty, tz) = t^n f(x, y, z)$$

两端分别对 x, y, z 求偏导函数，则得

$$t f'_1(tx, ty, tz) = t^n f'_1(x, y, z),$$

$$t f'_2(tx, ty, tz) = t^n f'_2(x, y, z),$$

$$t f'_3(tx, ty, tz) = t^n f'_3(x, y, z),$$

其中 $f'_1(\cdot, \cdot, \cdot), f'_2(\cdot, \cdot, \cdot), f'_3(\cdot, \cdot, \cdot)$ 分别代表

$f(\cdot, \cdot, \cdot)$ 对第一个，第二个，第三个变量的偏导数。

于是，

$$f'_1(tx, ty, tz) = t^{n-1} f'_1(x, y, z),$$

$$f'_2(tx, ty, tz) = t^{n-1} f'_2(x, y, z),$$

$$f'_3(tx, ty, tz) = t^{n-1} f'_3(x, y, z),$$

即偏导函数 $f'_x(x, y, z)$, $f'_y(x, y, z)$ 及 $f'_z(x, y, z)$

均为 $(n-1)$ 次的齐次函数,

3234. 设 $u = f(x, y, z)$ 是可微分两次的 n 次齐次函数. 证明

$$\left(x \frac{\partial}{\partial x} + y \frac{\partial}{\partial y} + z \frac{\partial}{\partial z}\right)^2 u = n(n-1)u.$$

证 由3233题知: $\frac{\partial u}{\partial x}$, $\frac{\partial u}{\partial y}$ 及 $\frac{\partial u}{\partial z}$ 均为 $(n-1)$ 次齐次函数. 应用尤拉定理, 即得

$$\left(x \frac{\partial}{\partial x} + y \frac{\partial}{\partial y} + z \frac{\partial}{\partial z}\right) \frac{\partial u}{\partial x} = (n-1) \frac{\partial u}{\partial x}, \quad (1)$$

$$\left(x \frac{\partial}{\partial x} + y \frac{\partial}{\partial y} + z \frac{\partial}{\partial z}\right) \frac{\partial u}{\partial y} = (n-1) \frac{\partial u}{\partial y}, \quad (2)$$

$$\left(x \frac{\partial}{\partial x} + y \frac{\partial}{\partial y} + z \frac{\partial}{\partial z}\right) \frac{\partial u}{\partial z} = (n-1) \frac{\partial u}{\partial z}. \quad (3)$$

将(1)式两端乘以 x , (2)式两端乘以 y , (3)式两端乘以 z , 然后相加, 即得

$$\begin{aligned} \left(x \frac{\partial}{\partial x} + y \frac{\partial}{\partial y} + z \frac{\partial}{\partial z}\right)^2 u &= (n-1) \left(x \frac{\partial u}{\partial x} + y \frac{\partial u}{\partial y} \right. \\ &\quad \left. + z \frac{\partial u}{\partial z}\right) = n(n-1)u, \end{aligned}$$

这就是所要证明的等式.

求下列函数的一阶和二阶微分(x, y, z 为自变数):

3235. $u = x^m y^n$.

解 $du = x^{m-1} y^{n-1} (m y dx + n x dy),$
 $d^2 u = m(m-1) x^{m-2} y^n dx^2 + 2mnx^{m-1} y^{n-1} dx dy$
 $+ n(n-1) x^m y^{n-2} dy^2$
 $= x^{m-2} y^{n-2} [m(m-1) y^2 dx^2 + 2mnxy dx dy$
 $+ n(n-1) x^2 dy^2].$

3236. $u = \frac{x}{y}$.

解 $du = \frac{y dx - x dy}{y^2},$
 $d^2 u = \frac{y^2 (dxdy - dx dy) - 2y dy (y dx - x dy)}{y^4}$
 $= -\frac{2}{y^3} (y dx - x dy) dy.$

3237. $u = \sqrt{x^2 + y^2}$.

解 $du = \frac{xdx + ydy}{\sqrt{x^2 + y^2}},$
 $d^2 u = \frac{d(xdx + ydy)}{\sqrt{x^2 + y^2}} + (xdx + ydy)$
 $\cdot d\left(\frac{1}{\sqrt{x^2 + y^2}}\right) = \frac{dx^2 + dy^2}{\sqrt{x^2 + y^2}} - \frac{(xdx + ydy)^2}{(x^2 + y^2)^{\frac{3}{2}}}$
 $= \frac{(ydx - xdy)^2}{(x^2 + y^2)^{\frac{3}{2}}}.$

3238. $u = \ln \sqrt{x^2 + y^2}$.

解 $du = \frac{xdx + ydy}{x^2 + y^2}$,

$$\begin{aligned} d^2u &= \frac{d(xdx + ydy)}{x^2 + y^2} - \frac{2(xdx + ydy)^2}{(x^2 + y^2)^2} \\ &= \frac{dx^2 + dy^2}{x^2 + y^2} - \frac{2(xdx + ydy)^2}{(x^2 + y^2)^2} \\ &= \frac{(y^2 - x^2)(dx^2 - dy^2) - 4xydx dy}{(x^2 + y^2)^2}. \end{aligned}$$

3239. $u = e^{xy}$.

解 $du = e^{xy}(ydx + xdy)$,

$$\begin{aligned} d^2u &= e^{xy}[(ydx + xdy)^2 + 2dxdy] \\ &= e^{xy}[y^2dx^2 + 2(1 + xy)dxdy + x^2dy^2]. \end{aligned}$$

3240. $u = xy + yz + zx$.

解 $du = (y + z)dx + (z + x)dy + (x + y)dz$,

$$d^2u = 2(dxdy + dydz + dzdx).$$

3241. $u = \frac{z}{x^2 + y^2}$.

解 $du = -\frac{2z}{(x^2 + y^2)^2}(xdx + ydy) + \frac{dz}{x^2 + y^2}$

$$= \frac{(x^2 + y^2)dz - 2z(xdx + ydy)}{(x^2 + y^2)^2},$$

$$\begin{aligned} d^2u &= \frac{1}{(x^2 + y^2)^4} \left\{ (x^2 + y^2)^2 [2(xdx + ydy)dz \right. \\ &\quad \left. - 2(xdx + ydy)dz - 2z(dx^2 + dy^2)] \right\} \end{aligned}$$